

Portable Gas Leak Detector

SP-220 Series

SP-220(TYPE M)

SP-220(TYPE L)

SP-220(TYPE ML)

Operating Manual

(PT0-139)

RIKEN KEIKI Co.,Ltd.

2-7-6 Azusawa, Itabashi-ku, Tokyo, 174-8744, Japan

Phone : +81-3-3966-1113

Fax : +81-3-3558-9110

E-mail : intdept@rikenkeiki.co.jp

Web site : <https://www.rikenkeiki.co.jp/>

Contents

1. Outline of the Product.....	3
Preface.....	3
Purpose of use.....	3
Definition of DANGER, WARNING, CAUTION and NOTE.....	3
How to check the standards and explosion-proof specifications	4
2. Important Notices on Safety.....	5
2-1. Danger cases.....	5
2-2. Warning cases.....	6
2-3. Precautions.....	7
2-4. Safety information (for ATEX/IECEX/UKEX specifications)	9
3. Product Components.....	10
3-1. Names and functions for each part	10
4. How to Use	13
4-1. Before using the detector	13
4-2. Preparation for start-up.....	13
4-3. How to replace the batteries.....	13
4-4. How to start the detector	15
4-5. Basic operating procedures.....	17
4-6. How to detect.....	18
4-7. Change of the alarm setpoint	19
4-8. Performing air calibration	20
4-9. Snap logger	21
4-10. Peak hold function	22
4-11. Change of the alarm and operation sounds	22
4-12. How to turn on the illumination lamp	23
4-13. Power-off	23
5. How to Set Display Mode.....	24
5-1. Entering the display mode.....	24
5-2. Measured gas switching setting	26
5-3. Log data display	27
6. How to Set User Mode	28
6-1. Entering the user mode	28
6-2. Date/time setting.....	30
6-3. Clock function ON/OFF setting.....	31
7. Alarm Function.....	32
7-1. Gas alarm activation.....	32
7-2. Fault alarm activation	32
8. Maintenance	33
8-1. Maintenance intervals and items.....	33
8-2. How to clean	35
8-3. Parts replacement	35
9. Storage and Disposal	38
9-1. Procedures to store the detector or leave it for a long time.....	38
9-2. Procedures to use the detector again	38
9-3. Disposal of products	39
10. Troubleshooting.....	40
11. Product Specifications	42
12. Appendix.....	43
12-1. Definition of terms.....	43

1

Outline of the Product

Preface

Thank you for choosing our portable gas leak detector SP-220 series (hereinafter referred to as the detector). Please check that the model number of the product you purchased is included in the specifications on this manual.

This manual explains how to use the detector and its specifications. It contains information required for using the detector properly. Not only the first-time users but also the users who have already used the product must read and understand the operating manual to enhance the knowledge and experience before using the detector.

Note that the contents of this manual are subject to change without notice for product improvement. It is also prohibited to copy or reproduce this manual, in whole or in part, without permission.

Regardless of warranty period, we shall not make any indemnification for accidents and damage caused by using the detector.

Make sure to read the warranty policy specified on the warranty.



Purpose of use

This detector is used to detect a single channel, such as city gas, LP gas, etc., in air.

It provides three different specifications: TYPE M used to detect leakage of city gases, TYPE L used to detect leakage of LP gases and TYPE ML used to detect leakage of city gases and LP gases with different calibration available for each type of gases. Detection results are not intended to guarantee life or safety in any way.

Definition of DANGER, WARNING, CAUTION and NOTE

Throughout this manual, the following indications are used to ensure safe and effective work.

 DANGER	This message indicates that improper handling may cause serious damage on life, health or assets.
 WARNING	This message indicates that improper handling may cause serious damage on health or assets.
 CAUTION	This message indicates that improper handling may cause minor damage on health or assets.
NOTE	This message indicates advice on handling.

How to check the standards and explosion-proof specifications

The detector has different specifications depending on the standards or explosion-proof certification type. Check the specifications of the product you have before use. See the Declaration of Conformity at the end of this operating manual for CE/UKCA marking specifications. For the product specifications, check the nameplate attached to the product shown in the following figure.

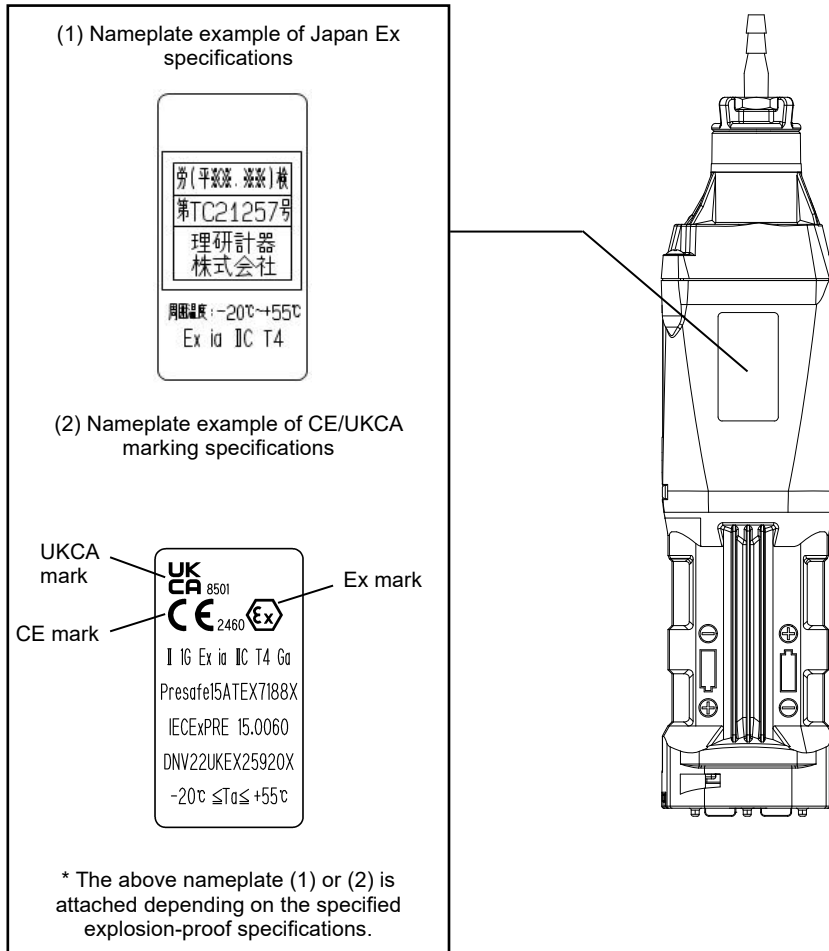

2

Important Notices on Safety

To maintain the performance and use the detector safely, observe the following instructions of DANGER, WARNING and CAUTION.

2-1. Danger cases



DANGER

About use

- While conducting measurement in a manhole or confined space, do not lean over or look into the manhole or closed space. It may lead to dangers because oxygen-deficient air or other gases may blow out.
- Oxygen-deficient air or other gases may be discharged from the gas exhausting outlet of the detector. Never inhale the air or gases.
- High-concentration (100% LEL or higher) gases may be discharged from the gas exhausting outlet of the detector. Never use fire near it.

2-2. Warning cases



WARNING

Sampling point pressure

- The concentration meter is designed to draw gases under the atmospheric pressure. If excessive pressure is applied to the gas inlet and outlet of the detector, measured gases may leak out from its inside and may cause dangerous conditions. Be sure that excessive pressure is not applied to them while used.

Air calibration in atmosphere

- When air calibration is performed in the atmosphere, check the atmosphere for freshness before beginning it. If interference gases or other gases exist, the adjustment cannot be performed properly, thus leading to dangers when the gas leaks.

Response to gas alarm

- A gas alarm is triggered by changes in temperature and humidity. In such a case, check the atmosphere for freshness and perform air again in the measured atmosphere.
Example) If the detector is turned on in a room with a temperature of 20°C and a humidity of 40% RH and taken outside (a temperature of 30°C and a humidity of 60% RH), an alarm is triggered by humidity changes. In such a case, perform air calibration outside and measure. The detector performs air calibration automatically when it is turned on. Even in such a case, check the atmosphere for freshness and perform air calibration again in the measured atmosphere.



WARNING

Battery level check

- Before use, check that there remains sufficient battery power. When the detector is not used for a long period, the batteries may be exhausted. Never fail to replace them with new ones before use.
- If a low battery voltage alarm is triggered, gas detection cannot be conducted. If the alarm is triggered during use, turn off the power and promptly replace the batteries in a safe area.

Others

- Do not throw the detector into fire.
- Do not wash the detector in a washing machine or ultrasonic cleaner, etc.
- Do not block the buzzer sound opening. No alarm sound can be heard.
- Do not remove the battery while the power is on.

2-3. Precautions



CAUTION

Do not use the detector where it is exposed to oil, chemicals, etc. Do not submerge the detector under water on purpose.

- Do not use in a place where the detector is exposed to liquids such as oil and chemicals.
- The detector is not water-pressure-resistant. Do not use the detector where a high water pressure is applied to it (under a faucet, shower, etc.) or submerge it under water for a long time. The detector is water-proof only in fresh water and running water, and not in hot water, salt water, detergent, chemicals, human sweat, etc.
- The gas inlet and outlet are not water-proof. Be careful not to let water such as rainwater, etc. get into these parts. Because this may cause trouble and gas cannot be detected.
- Do not place the detector where water or dirt gets accumulated. The detector placed at such a location may cause malfunction due to water or dirt that gets into the buzzer opening, etc.
- Note that drawing in dirty water, dust, metallic powder, etc. will significantly deteriorate the sensor sensitivities. Be careful when the detector is used in an environment where these elements exist.

Do not use the detector in a place where the temperature drops below -20°C or rises over 55°C.

- The operating temperature of the detector is -20 to +55°C. Do not use the detector at higher temperatures, humidities and pressures or at lower temperatures than the operating range.
- Avoid long-term use of the detector in a place where it is exposed to direct sunlight.
- Do not store the detector in a sun-heated car.
- Avoid a sudden humidity or temperature change.
- Do not leave the detector in a place with high temperature and humidity for a long time. The performance of the unit may deteriorate.

Observe the operating restrictions to prevent condensation inside the concentration meter or gas sampling hose.

- Condensation formed on the detector or taper nozzle causes clogging, gas adsorption, etc., which may disturb accurate gas detection. Thus, condensation must be avoided. In addition to the installation environment, carefully monitor the temperature/humidity of the sampling point to prevent condensation, etc. on the detector or taper nozzle. Please observe the operating restrictions.

Do not use a transceiver near the detector.

- Radio wave from a transceiver or other device near the detector may disturb readings. If a transceiver or other radio wave transmitting device is used, it must be used in a place where it disturbs nothing.
- Do not use the detector near a device that emits strong electromagnetic waves (high-frequency or high-voltage devices).

Verify that the flow check display is rotating before using the detector.

- If the flow check display is not rotating, gas detection cannot be performed properly. Check whether the flow rate is lost.

Never fail to perform a regular maintenance.

- Since this is a precision devices, a regular maintenance must be performed. Continuing to use the detector without performing maintenance will compromise the sensitivity of the sensor, thus resulting in inaccurate gas detection.



CAUTION

Others

- After a gas continuously comes into contact or a highly-concentrated gas comes into contact, the alarm pattern may continue. In such a case, draw cleaned air for more than five minutes (recommended) and perform air calibration again.
- Pressing buttons unnecessarily may change the settings, preventing alarms from activating correctly. Operate the detector using only the procedures described in this operating manual.
- Do not drop or give shock to the detector. The accuracy of the detector may be deteriorated.
- Do not jab the buzzer opening with a sharp-pointed item. Doing so may cause a failure or damage.
- Do not remove the panel sheet on the display. The water-proof and dust-proof performances will be deteriorated.
- Do not affix a label or the like on the infrared port. Infrared communications can no longer be conducted.
- The operating environment may include gases that have harmful effects on the sensor of the detector. The detector cannot be used in the presence of the following gases:
(1) High-concentration sulfides (such as H₂S, SO₂, etc.)
(2) Halogen gases (such as chloride compounds, etc.)
(3) Silicone (Si compounds)
(4) High-concentration solvent gases
Do not use the detector in the presence of the above (1), (2), and (3) gases (such as high-concentration sulfides, halogen gases, silicone, etc.), which may shorten the sensor life significantly or cause malfunctions such as inaccurate readings.
In case the detector is used for detection in the presence of silicone, etc., be sure to check the gas sensitivities before using it again.
If the above (4) gas (high-concentration solvent gas) is exposed, a crack may occur in the unit. Thus, do not use high-concentration solvent gases.

About battery replacement

- Never fail to turn off the power of the detector before replacing the batteries.
- Replace both of the two batteries with new ones at one time.
- Pay attention to the polarities of the batteries.

Usage

- In a low-temperature environment, the operating time is shortened due to the battery performance property.
- At low temperatures, the responses of the LCD display may slow down.
- Perform air calibration under pressure and temperature/humidity conditions close to those in the operating environment and in fresh air.
- Perform air calibration after the reading is stabilized.
- If there is a sudden temperature change of 15°C or more between the storage and operational locations, turn on the power of the detector, let it stand for more than 5 minutes in a similar environment to the operational location, and perform air calibration in fresh air before using it.
- When cleaning the detector, do not splash water over it or use organic solvents such as alcohol and benzene on it. The surface of the detector may be discolored or damaged.
- If the detector is not used for a long time, turn on the power at least once every six months and check that the pump draws in air (about three minutes). The detector, when not activated for a long time, may cease to work because of hardening of the grease in the pump motor.
- If the detector is not used for a long time, store it after removing the batteries. Battery leaks may result in fire, injury, etc.
- When the detector is used again after a long-period storage, never fail to perform air calibration. For information on readjustment including air calibration, please contact RIKEN KEIKI.

2-4. Safety information (for ATEX/IECEX/UKEX specifications)

The portable gas leak detector SP-220 is a gas detector to continuously detect combustible gases. The detector draws gases with the internal micro pump. Use only two TOSHIBA AA alkaline batteries (LR6T) connected in series for power supply. Do not replace the dry batteries in a hazardous location.

Explosion-proof specifications

- Ex ia IIC T4 Ga



II 1 G Ex ia IIC T4 Ga

- Operating temperature range: -20 to +55°C

Electrical specifications

- Only TOSHIBA AA alkaline batteries (LR6T) can be used.

Certificate Number

- IECEX: IECEX PRE 15.0060
- ATEX: Presafe15 ATEX7188X
- UKEX: DNV 22 UKEX 25920X

Applied standards

- | | | |
|---------------------|-----------------------|--------------------------|
| · IEC 60079-0:2017 | · EN IEC 60079-0:2018 | · BS EN IEC 60079-0:2018 |
| · IEC 60079-11:2011 | · EN60079-11:2012 | · BS EN 60079-11:2012 |

Specific conditions of “X”-mark:

Regarding ATEX specification, the measuring function according to Annex II paragraph 1.5.5 of the Directive is not covered by this EU-type examination.

It shall comply with the requirements from the relevant European harmonized standards which provide guidance on the performance of gas detection equipment and safety devices.

The measuring function according to schedule 1, paragraph 24 of the Regulation is not covered in this UK-type examination. It shall comply with the requirements from the relevant UK Designated Standards which provide guidance on the performance of gas detection equipment.

WARNING

- Do not replace the battery unit in a hazardous location.
- Do not replace the dry batteries in a hazardous location.
- Do not disassemble/modify the unit.
- Use only TOSHIBA AA alkaline batteries (LR6T) for the dry battery unit.

INST. No. 0 0 0 0 0 0 0 0 0 0

A B C D E

- A: Manufacturing year (0-9)
- B: Manufacturing month (1-9, XYZ for Oct.-Dec.)
- C: Manufacturing lot
- D: Serial number
- E: Factory code

Manufacturer



RIKEN KEIKI CO., LTD.
2-7-6 Azusawa, Itabashi-ku, Tokyo, 174-8744 Japan
Web site: <https://www.rikenkeiki.co.jp/>

NOTE

TOSHIBA AA alkaline batteries (LR6) can be used for Japan Ex specifications.

3

Product Components

3-1. Names and functions for each part

This section describes names and functions of main unit and battery unit parts and LCD display.

Main unit

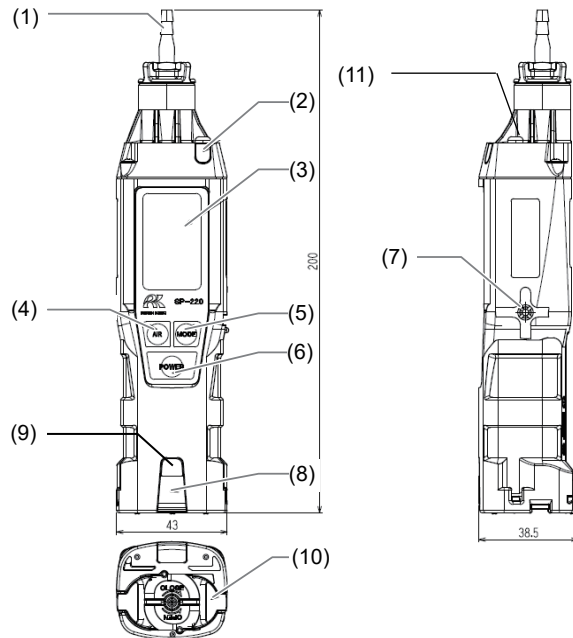

No.	Name	Function
(1)	Gas inlet	Collects gases.
(2)	Alarm LED arrays	Blinks or lights up in response to an alarm.
(3)	LCD display	Displays gas concentrations, measured gas name, alarms, etc.
(4)	AIR button	Keep this switch pressed to perform air calibration. Used to change the screen and decrease numerical values in the setting mode.
(5)	MODE button	Press this switch to change between display modes. Used to change the screen and increase numerical values in the setting mode.
(6)	POWER button	Turns the power ON or OFF. Used to change the screen and confirm values in the setting mode.
(7)	Gas outlet	Exhausts the gas drawn into the detector. (Do not block it.)
(8)	Alarm LED arrays	Blinks or lights up in response to an alarm.
(9)	Infrared port	Used during infrared communications.
(10)	Battery cover	Protects the battery. Remove it to replace the batteries.
(11)	LED light	Provides you light for work.

Standard accessories

Unpack and check the main unit and accessories.

- AA alkaline battery (2 pcs) (installed)
- Taper nozzle (1 pc)
- Rubber protection cover (1 pc) (Protect the detector from shocks by being hit, etc.)
- Hand strap (1 pc)
- Waterproofing filter for exchange (5 pcs)
- Product warranty (1 pc)
- Operating manual (1 pc)

Name	Appearance/ weight	Quantity	Name	Appearance/ weight	Quantity
Rubber protection cover	<p>Approx. 42.5 mm</p> <p>Approx. 149 mm</p> <p>Approx. 47 mm</p> <p>Approx. 42 g</p>	1 pc (attached)	AA alkaline battery	<p>Approx. 50 mm</p> <p>Approx. 14.5 mm</p> <p>Approx. 44 g</p>	2 pcs (installed)
Taper nozzle	<p>Approx. 70 mm</p> <p>RIKEN KEIKI</p> <p>Approx. 9 g</p>	1 pc	Hand strap	<p>Approx. 150 mm</p> <p>Approx. 2 g</p>	1 pc
Water-proofing filter for exchange	<p>Plastic bag</p> <p>Approx. φ16 mm</p> <p>Approx. 1g</p>	1 bag (5 pcs included)	Operating manual	—	1 pc
			Product warranty	—	1 pc

If there is anything missing, contact RIKEN KEIKI.



CAUTION



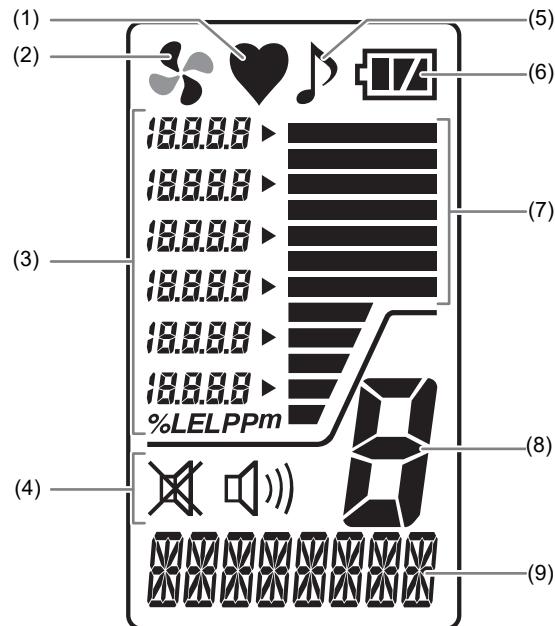

- Do not remove the panel sheet on the display. The water-proof and dust-proof performances will be deteriorated.
- Do not affix a label or the like on the infrared port. Infrared communications can no longer be conducted.

LCD display



No.	Name	Function
(1)	Operating state display	Displays the operating status in the detection mode. Normal: Blinking
(2)	Flow check display	Displays the drawing status. Normal: Rotating
(3)	Gas concentration display	Displays gas concentration and unit.
(4)	Alarm sound display	Displays the setting status of the alarm sound.
(5)	Operation sound display	Displays the setting status of the operation sound.
(6)	Battery level icon	Displays a reference of the battery level.
(7)	Bar meter display	Displays the level of gas concentration with the bar meter
(8)	Mode display	Displays the measuring mode status.
(9)	Gas name and message display	Displays the gas name and a message according to the function.

NOTE

- The meanings of battery level icons are as follows:
 : Sufficient/  : Low/  : Needs replacement If the battery level further drops, the inside of the battery icon starts to blink ().

4

How to Use

4-1. Before using the detector

Not only the first-time users but also the users who have already used the detector must follow the operating precautions.

Ignoring the precautions may damage the unit, resulting in inaccurate gas measurement.

4-2. Preparation for start-up



CAUTION

- The display is covered by the protective film to prevent scratches from shipping.
- Be sure to remove this film before use.
- Gas monitor with this film will not satisfy the explosion-proof performance.

Before starting gas detection, check the followings.

- Check that the protective film attached on the display from shipping is removed
- The batteries are installed (with sufficient battery level).
- Check that the taper nozzle and filter are not contaminated.
- Check that the taper nozzle is not bent or has no hole.
- Check that the nipple to which the taper nozzle is attached is not loose.

4-3. How to replace the batteries

When the detector is used for the first time, or when the battery level is low, attach two new AA alkaline batteries according to the following procedures.

1 Check that the power of the detector is turned off.

Turn off the power if it is turned on.

2 Turn the lock plate counterclockwise and open the battery cover.

3 Remove old batteries and then put new batteries while observing the correct polarity.

4 Close the battery cover and turn the lock plate clockwise to lock.

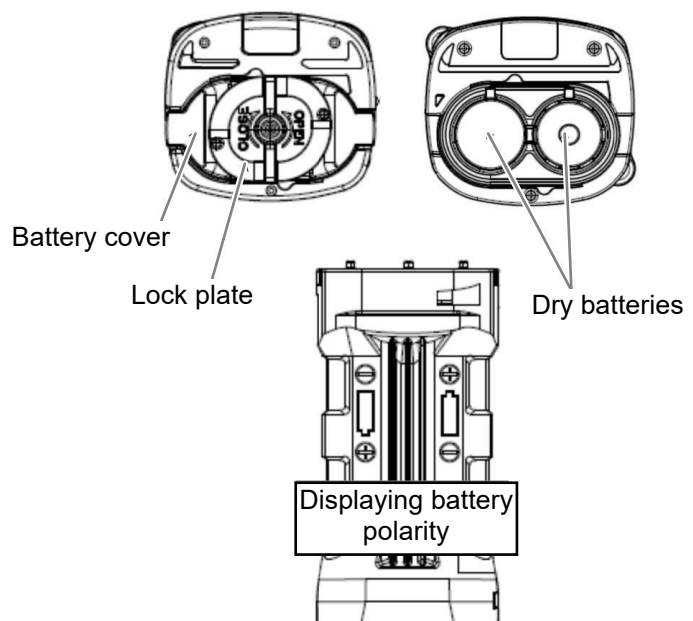

**CAUTION**

- Never fail to turn off the power of the detector before replacing the batteries.
- Replace the batteries in a safe place.
- Replace both of the two batteries with new ones at one time.
- Pay attention to the polarities during replacement. Replace while checking the battery polarities stamped on the body.
- If the battery cover is not completely locked, the dry batteries may drop off or water may get in through the clearance. Water may also get in if a minute foreign substance is caught between the detector and battery cover.

4-4. How to start the detector

When the power is turned on, a self-diagnostic starts, and then the detector enters the detection mode.

Power-on

Press and hold the **POWER** button until the buzzer blips (one second or longer) to turn on the power. When the power is turned on, the LCD display changes automatically as shown below, and the detector enters the detection mode.

(Display example: For city gases)

1 Press and hold the **POWER** button for one second or longer.

Hold it down until all the LCDs and alarm lamp light up and the buzzer blips.

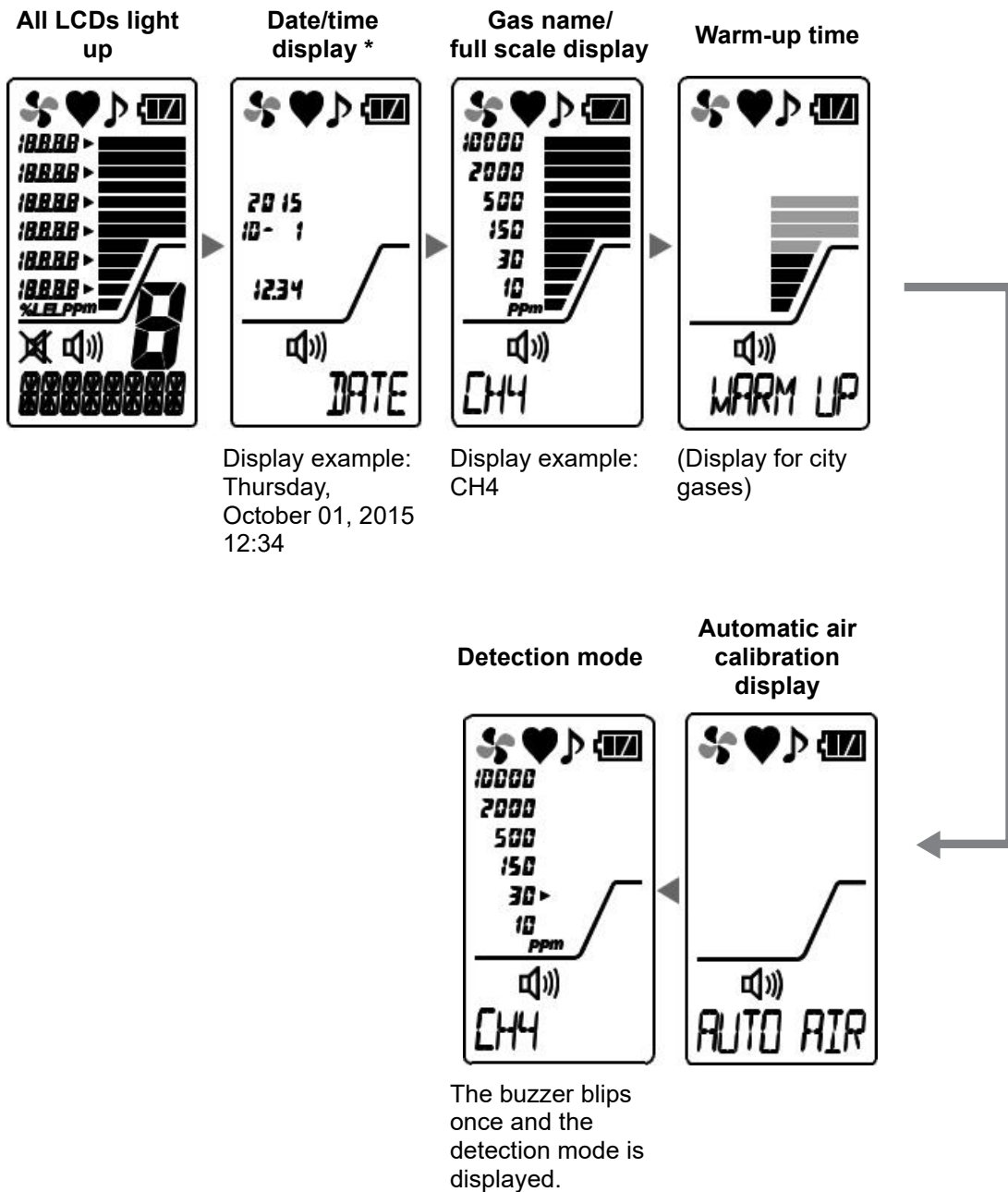

- * The date/time display is displayed only when the clock function is enabled. It is not displayed because the clock function is disabled by default.
To enable the clock function, see "6-3. Clock function ON/OFF setting" on page 31.

NOTE

- When powering on after leaving the detector for more than five minutes with the batteries removed, such as when powering on for the first time, replacing the batteries, etc., or powering on with the batteries inserted with incorrect polarities, a clock abnormality (FAIL CLOCK) may be triggered. When it is reset using the MODE button, the detector moves to the date/time setting screen. See "6-2. Date/time setting" on page 30 and set the date/time.
- Warm-up time (WARM UP) is different depending on the stability status of the sensor.
- If the detector is not used for a long period, warm-up time may be longer or a sensor abnormality (FAIL SENSOR) may be displayed. In such a case, restart the detector.
- The detector performs air calibration automatically on start-up. If an environment where the detector is turned on is different from the measured atmosphere, perform air calibration again in the measured atmosphere.

About LCD backlight

- Pressing the **AIR**, **MODE** or **POWER** button turns on the LCD backlight. The LCD backlight goes off after 30 seconds or so of no operation.
When an alarm is triggered, the LCD backlight lights up automatically.
-

4-5. Basic operating procedures

The detection mode is used after power-on.
 (Display example: For city gases)

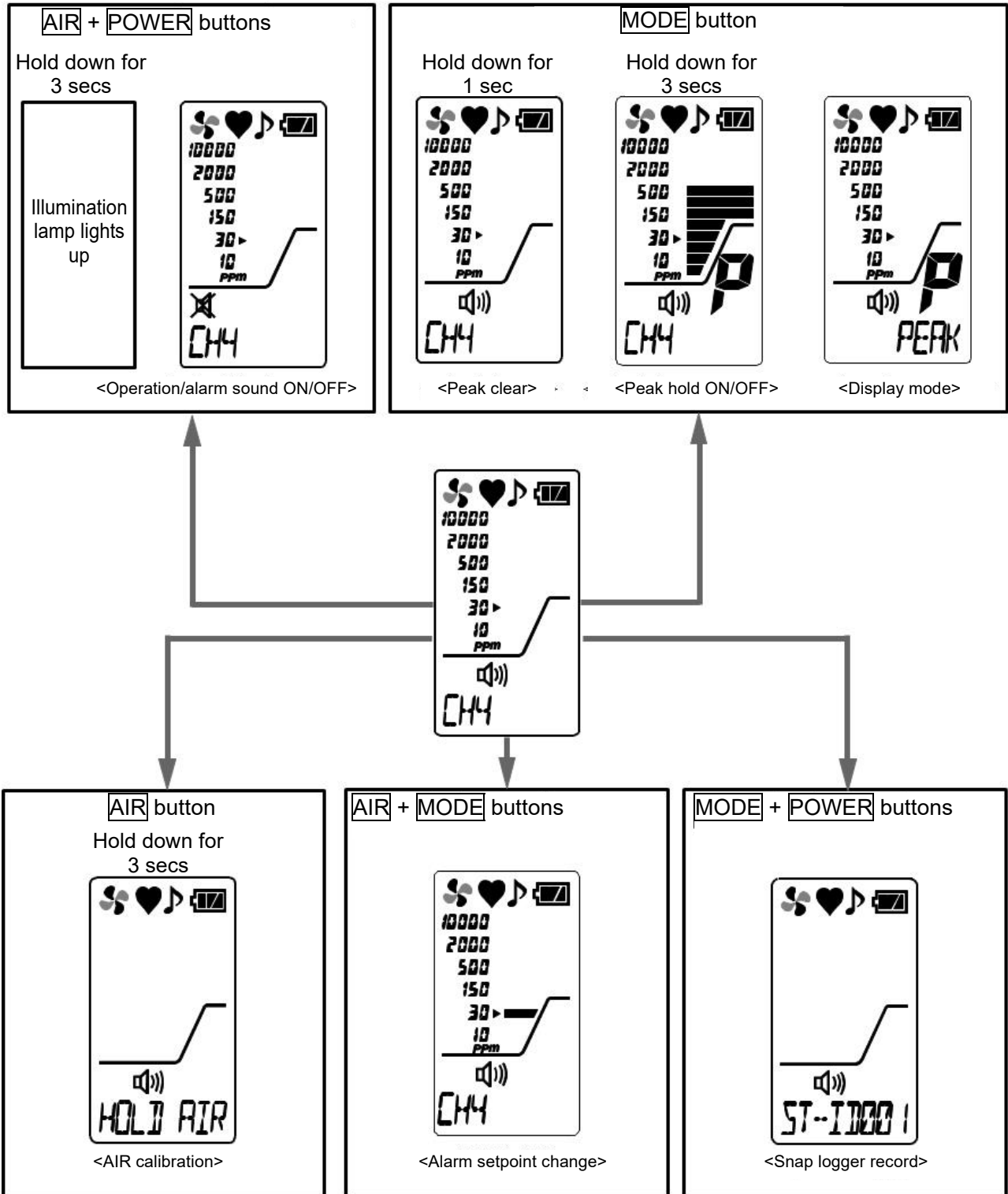

* Displayed only when the clock function is enabled. See "6-3. Clock function ON/OFF setting" on page 31.

4-6. How to detect

Put the tip of the taper nozzle close to the detection area in the detection mode and perform gas detection. If a gas is drawn, the detected gas concentration is displayed with the bar meter on the LCD display.



DANGER

- While conducting measurement in a manhole or confined space, do not lean over or look into the manhole or closed space. It may lead to dangers because oxygen-deficient air or other gases may blow out.
- Oxygen-deficient air or other gases may be discharged from the gas exhausting outlet of the detector. Never inhale the air or gases.
- High-concentration (100% LEL or higher) combustible gases may be discharged from the gas exhausting outlet of the detector. Never use fire near it.



WARNING

- The detector is designed to draw gases around it under the atmospheric pressure. If excessive pressure is applied to the gas inlet and outlet of the detector, detected gases may leak out from its inside and may cause dangerous conditions. Be sure that excessive pressure is not applied to the detector while used.
- When air calibration is performed in the atmosphere, check the atmosphere for freshness before beginning it. If interference gases or other gases exist, the adjustment cannot be performed properly, thus leading to dangers when the gas leaks.
- Issuance of a gas alarm indicates that there are extreme dangers. Take proper actions based on your judgment.
- Before use, check that there remains sufficient battery power. When the detector is not used for a long period, the batteries may be exhausted. Never fail to replace them with new ones before use.
- If a low battery alarm is triggered, gas detection cannot be conducted. If the alarm is triggered during use, turn off the power and promptly replace the batteries in a safe area.
- Do not block the buzzer sound opening. No alarm sound can be heard.
- If the main unit is dropped or given a shock, the reading may rise and it may remain so. In such a case, perform air calibration in a place where the surrounding air is fresh.



CAUTION

- Before performing gas detection, attach the taper nozzle provided with the detector to prevent disturbances by air dust.

4-7. Change of the alarm setpoint

In the detector, the alarm setpoint of city gas (CH₄) and LP gas (LPG) is factory set to 30 ppm. The alarm setpoint can be changed, depending on the purpose, in five levels.

How to change the alarm setpoint

1 In the detection mode, press the **AIR** and **MODE** buttons at the same time.

The alarm setpoint changes by five every time the **AIR** and **MODE** buttons are pressed.

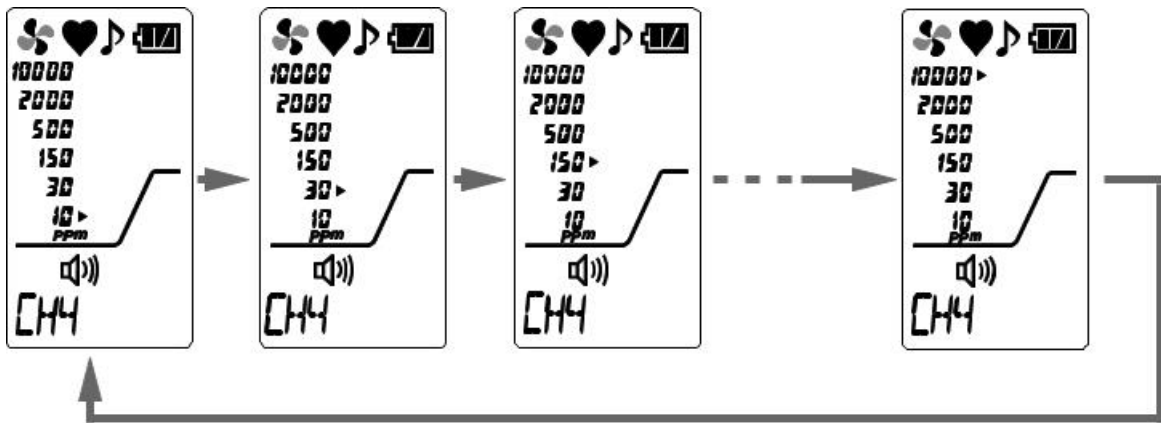

NOTE

- The alarm setpoint cannot be set to 10000 ppm.

4-8. Performing air calibration

After a high-concentration gas is detected or an alarm is triggered by temperature/humidity changes, perform air calibration in the measured atmosphere.

* Before performing air calibration, check that the surrounding air is fresh.
(Display example: For city gases)

- 1 In the detection mode, hold down the AIR button.**

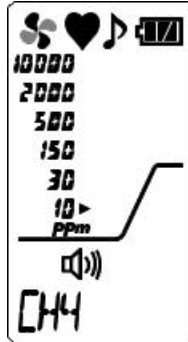

(Display for city gases)

- 2 Release the AIR button when the display changes from "HOLD AIR" to "RELEASE".**

(Buzzer sound: Three times <blip, blip, blip>)

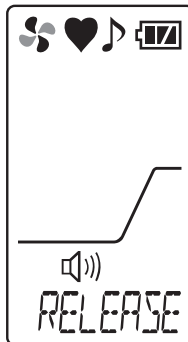
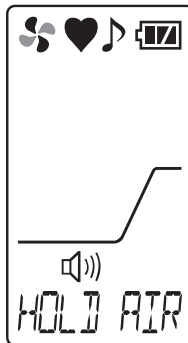

The air calibration is done and the detector returns to detection mode.
(Buzzer sound: Once <blip>)

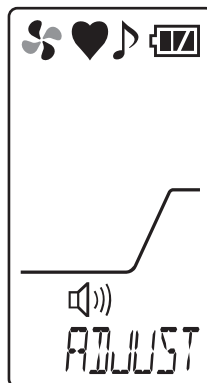

If air calibration fails, "FAIL AIR CAL" is displayed. Perform air calibration again in fresh surrounding air.

NOTE

- Perform air calibration under pressure and temperature/humidity conditions close to those in the operating environment and in fresh air.
- Perform air calibration after the reading is stabilized.
- If there is a sudden temperature change between the storage and operational locations, turn on the power of the detector, let it stand for five minutes or more in a similar environment to the operational location, and perform air calibration in fresh air before using it.

4-9. Snap logger

Any peak value during measurement can be recorded.

Up to 256 points of data can be recorded. When the number of recorded data points reaches the maximum, recorded data will be overwritten, starting from the oldest data.

This function is enabled when the clock function is enabled. Since the clock function is disabled by default, enable it before using the snap logger function (See "6-3. Clock function ON/OFF setting" on page 31).

- 1 In the detection mode, press the **MODE** and **POWER** buttons at the same time.**

The detector enters the station ID selection screen.

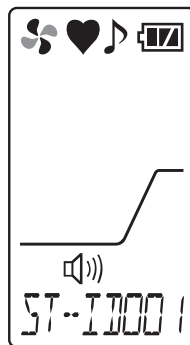

- 2 Use the **MODE** or **AIR** button to select the station ID and press the **POWER** button.**

The peak value is displayed.

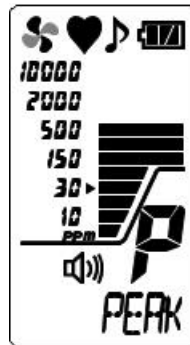

To stop recording, press the **AIR** and **MODE** buttons at the same time. The detector returns to the detection mode.

- 3 Press the **POWER** button.**

The date/time and peak value are recorded.

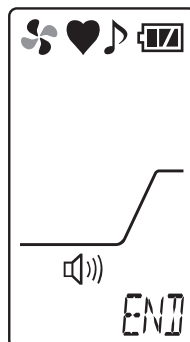

To continue recording the log, repeat steps 2 to 3.
To stop recording the log, press the **AIR** and **MODE** buttons at the same time. The detector returns to the detection mode.

NOTE

- The recorded data can be read out by the "Data Logger Management Program" (optional). See the operating manual of "Data Logger Management Program" for more information.

4-10. Peak hold function

When the peak hold function is enabled, the latest peak value is always displayed with the bar meter.
 (Display example: For city gases)

- In the detection mode, hold down the **MODE** button (for three seconds or longer).**

The peak hold function is enabled. While the peak hold function is enabled, "P" is displayed on the LCD display.

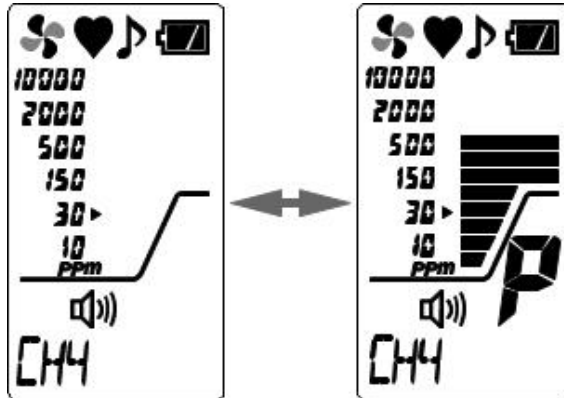

To disable the peak hold function, hold down the **MODE** button for three seconds or longer.

NOTE

- To clear a retained peak value, hold down the **MODE** button (for one second) in the detection mode.

4-11. Change of the alarm and operation sounds

Turn the alarm and operation sounds ON or OFF.
 (Display example: For city gases)

- In the detection mode, press the **AIR** and **POWER** buttons at the same time.**

The settings for the alarm and operation sounds are switched every time the **AIR** and **POWER** buttons are pressed.

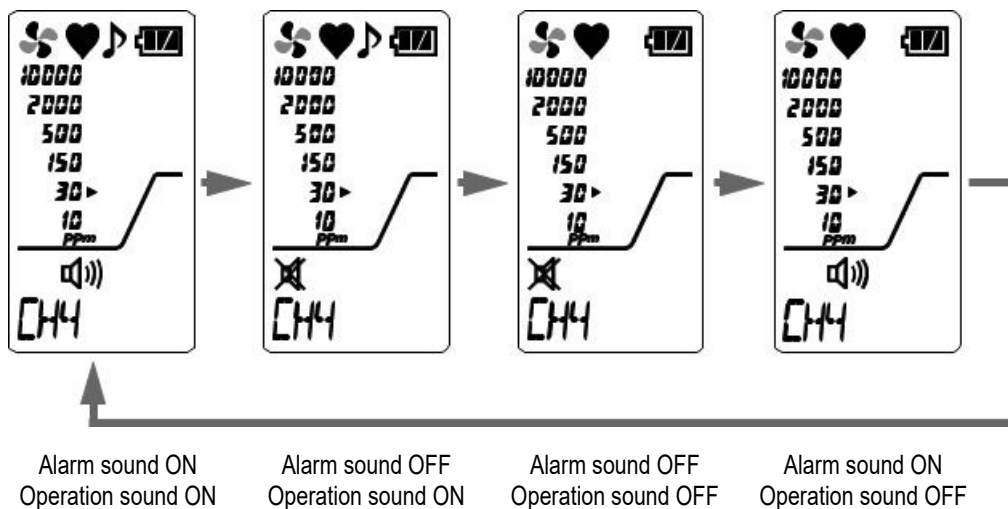

4-12. How to turn on the illumination lamp

The illumination lamp can be turned on when a measuring place is dark or in other situation.

1 Hold down the **AIR** and **POWER** buttons at the same time (for three seconds or longer).

The illumination lamp lights up. The illumination lamp will automatically go off in about two minutes after it lights up.

To turn off the illumination lamp, hold down the **AIR** and **POWER** buttons at the same time (for three seconds or longer).

4-13. Power-off

Press and hold the **POWER** button (at least three seconds) until the buzzer blips three times ("TURN OFF" disappears) to turn off the power.



CAUTION

- If a gas remains in the detector, it enters the automatic exhaust mode (for a maximum of 30 seconds). However, the detector is turned off after the automatic exhaust mode. The mode counts down from automatic exhaust start (PURGE 30). The detector switches to the "TURN OFF" display when the gas exhaust is completed and is turned off.

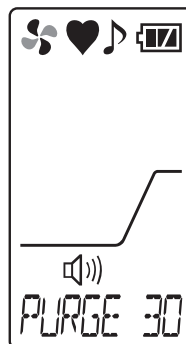

Automatic exhaust start (PURGE 30)

5

How to Set Display Mode

5-1. Entering the display mode

This mode allows users to view and change various display settings and perform other operation.
(Display example: For city gases)

1 In the detection mode, press the **MODE button.**

The detector enters the peak value display in the display mode.

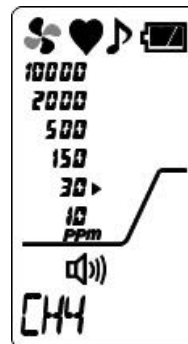

2 Next, press the **MODE button to display the appropriate menu.**

The setting screen for the display mode is switched every time the button is pressed. Holding down the button also switches the setting screen. When the detector returns to the detection mode, the setting screen stops being switched.

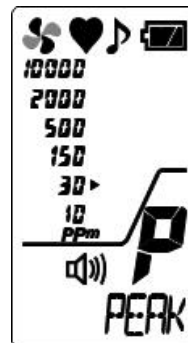

3 Select the setting item and press the **POWER button.**

For setting items, see "Display mode overview" on page 25.

NOTE

- The detector automatically returns to the detection mode in about 20 seconds if the detector is left unoperated.
- Gas detection is continued in the display mode and an alarm can be activated.

Display mode overview

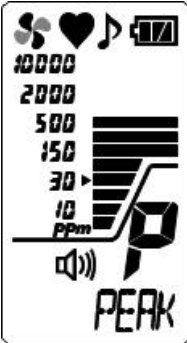
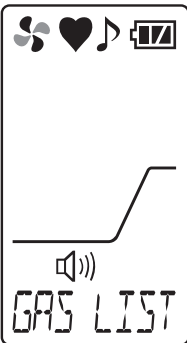
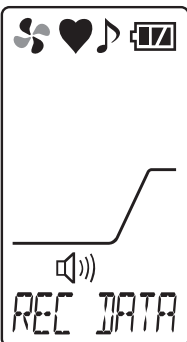
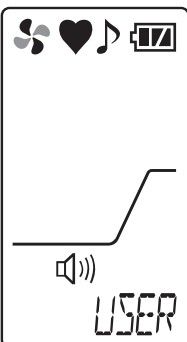
Item	LCD display	Details
Peak display		<p>Displays the maximum concentration detected during the period from power-on to the point of checking.</p> <p>* To clear the peak display, hold down the AIR button until "PEAK CLR" is displayed.</p>
Measured gas switching setting		<p>By changing the setting to the pre-registered gas in the detector, the converted concentration from the detection target gas will be displayed. (P. 26)</p>
Log data display		<p>Displays the data recorded by the snap logger. (P. 27)</p> <p>* Displayed only when the clock function is enabled See "6-3. Clock function ON/OFF setting" on page 31.</p>
Entering user mode		<p>Enters the user mode. (P. 28)</p>

5-2. Measured gas switching setting

Normally, the concentration display of the detector is "CH4 or LPG" by default depending on the specifications; however, the display can be switched between LPG and CH4 according to the specifications to detect its concentration.

(Display example: For city gases)

- 1 On the "GAS LIST" screen in the display mode, press the **POWER** button.**

The detector enters the gas reading setting.

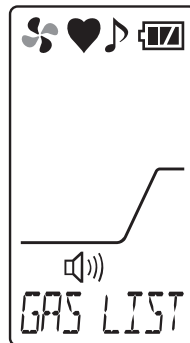

The currently set gas name is displayed.

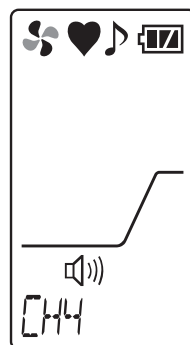

- 2 Press the **MODE** or **AIR** button to select a gas name to be read instead.**

The gas name switches to another every time the button is pressed.

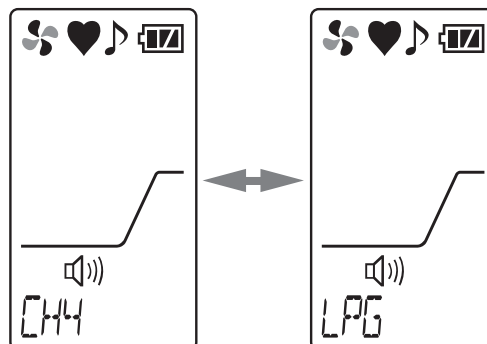

- 3 When the target gas name is displayed, press the **POWER** button.**

"END" is displayed, returning to the display mode.

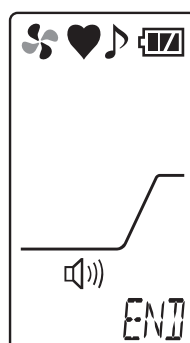

5-3. Log data display

The data recorded by the snap logger can be viewed.

The "REC DATA" screen is displayed only when the clock function is enabled (See "6-3. Clock function ON/OFF setting" on page 31).

(Display example: For city gases)

- On the "REC DATA" screen in the display mode, press the **POWER** button.**

The detector enters the log data display.

The recorded date/time is displayed and the station ID and memory number are displayed alternately. If there is no recorded data, "NO DATA" is displayed.

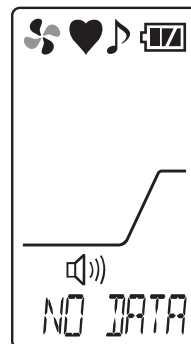
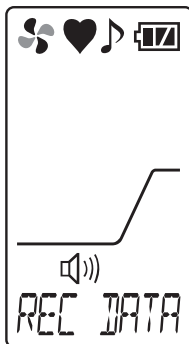

* When there is no recorded data

- Press the **MODE** or **AIR** button to select log data to be displayed.**

The recorded content switches to the other every time the button is pressed.

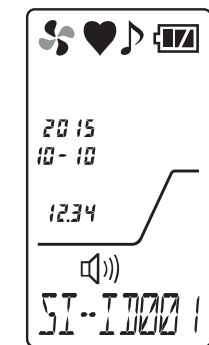

<Station ID>

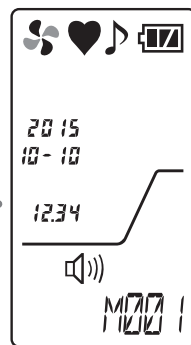

<Memory number>

- When the target log data is displayed, press the **POWER** button.**

The gas name and peak value of the selected memory are displayed alternately.

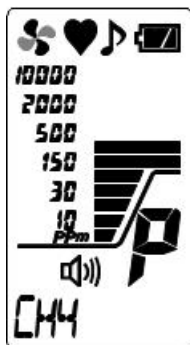

- To exit the display, press the **MODE** and **AIR** buttons at the same time.**

The detector returns to the display mode.

6

How to Set User Mode

6-1. Entering the user mode

The maintenance including internal clock correction, etc. can be performed.
(Display example: For city gases)

- 1 In the detection mode, press the **MODE** button a few times to display "USER" and then press the **POWER** button.**

The detector enters the date/time setting in the user mode.

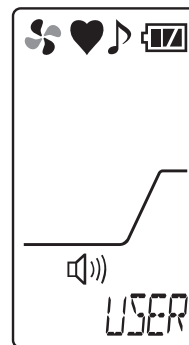

- 2 Next, press the **MODE** or **AIR** button to display the appropriate menu.**

The setting screen for the user mode switches to another every time the button is pressed.

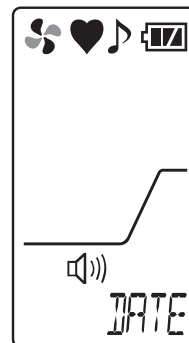

- 3 Select the setting item and press the **POWER** button.**

For setting items, see "User mode overview" on page 29.



CAUTION

- Return to the detection mode after use.

User mode overview

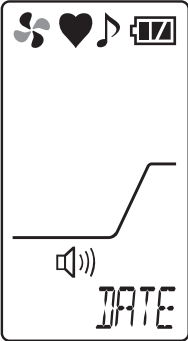
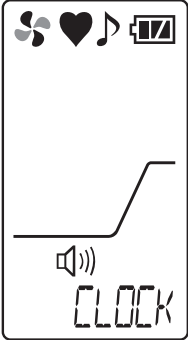
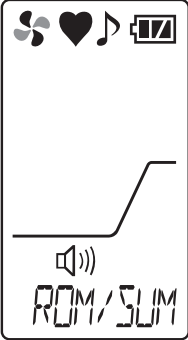
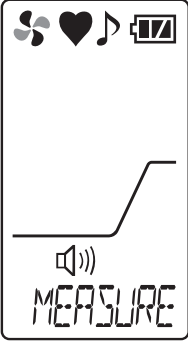
Item	LCD display	Details
<p>Date/time setting</p>		<p>Set the date/time of the internal clock. (P. 30)</p> <p>* When the clock function is disabled, the date/time setting screen is not displayed.</p>
<p>Clock function ON/OFF setting</p>		<p>Enable or disable the clock function.</p>
<p>ROM/SUM display</p>		<p>Displays the program number and SUM value of the detector. * This is not typically used by the user.</p>
<p>Entering detection mode</p>		<p>To exit the user mode, press the POWER button to enter the detection mode.</p>

6-2. Date/time setting

Set the date/time of the internal clock.

The date/time setting screen is displayed only when the clock function is enabled. Enable the clock function in "6-3. Clock function ON/OFF setting" on page 31 before setting the date/time.

- 1 On the "DATE" screen in the user mode, press the **POWER** button.**

The detector enters the date/time setting.

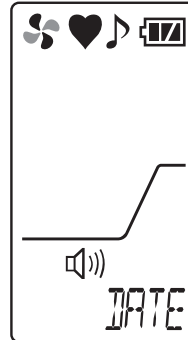

- 2 Press the **MODE** or **AIR** button, set the date/time and press the **POWER** button.**

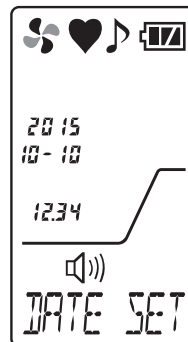

- 3 Set year -> month -> day -> hour -> minute in this order.**

When the "minute" value is confirmed, "END" is displayed and then the detector returns to the user mode menu.

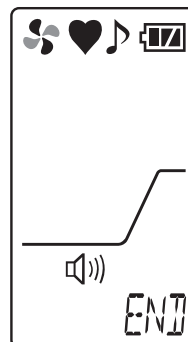

6-3. Clock function ON/OFF setting

Enable or disable the clock function.

The clock function is disabled by default. If the date/time needs to be displayed on start-up or the snap logger function is used, enable the clock function.

- 1 On the "CLOCK" screen in the user mode, press the **POWER** button.

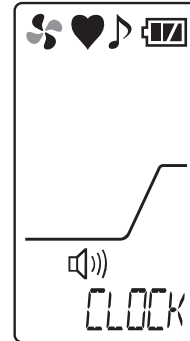

- 2 Press the **MODE** or **AIR** button, select ON/OFF of the clock function and press the **POWER** button.

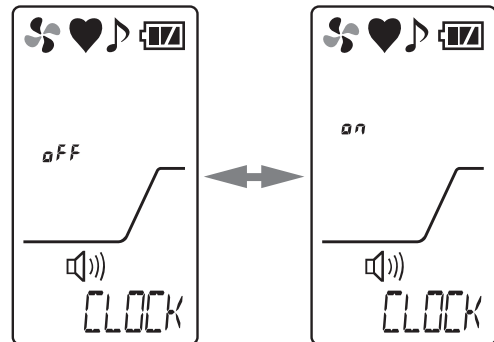

- 3 **Setting completed**

After the clock function ON/OFF setting is completed, "END" is displayed and then the detector returns to the user mode menu.

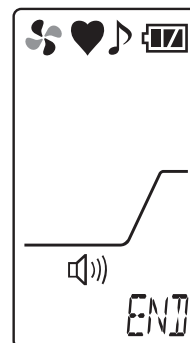

NOTE

- When the clock function is changed from disabled to enabled, a clock abnormality (FAIL CLOCK) may be triggered if the date/time is inaccurate. When the failure condition is reset using the MODE button, the detector moves to the date/time setting screen. Set the date/time in accordance with "6-2. Date/time setting" on page 30.
- When the clock function is changed from disabled to enabled for the first time, powered on after leaving the detector for more than five minutes with the batteries removed, or powered on with the batteries inserted with incorrect polarities, a clock abnormality (FAIL CLOCK) may be triggered.

7

Alarm Function

7-1. Gas alarm activation

"Gas alarm" is triggered in the detector using a blinking alarm lamp, buzzer sound and bar meter display when the concentration of detected gas reaches or exceeds the alarm setpoint values. (Auto-reset operation)

Blinking alarm lamp and buzzer sound operation for gas alarms have different intervals depending on the detected concentration.

7-2. Fault alarm activation

"Fault alarm" is triggered using a buzzer sound and blinking alarm lamp when an abnormality is detected in the detector. (Self-latching)

When an alarm is triggered, one of the following fault details is displayed on the LCD.

- | | | | |
|-----------------------------|-----------------|-----------------------|----------------|
| - System abnormalities | : FAIL SYSTEM | - Battery voltage low | : FAIL BATTERY |
| - Calibration abnormalities | : FAIL AIR CAL | - Clock abnormalities | : FAIL CLOCK |
| - Low flow rate | : FAIL LOW FLOW | - Pump abnormalities | : FAIL PUMP |
| - Sensor abnormalities | : FAIL SENSOR | | |

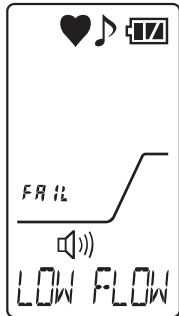
Alarm lamp	Repeatedly blinks at about one-second intervals.
Buzzer	Repeatedly sounds intermittent beeps at about one-second intervals. Blip-blip, blip-blip
LCD display	Display example of low flow rate (LOW FLOW) 

If a fault alarm is triggered, determine the cause and take appropriate action.

If the unit has problems and is repeatedly malfunctioning, contact RIKEN KEIKI immediately.

- The recorded data can be read out by the "Data Logger Management Program" (optional). See the operating manual of "Data Logger Management Program" for more information.

8

Maintenance

The detector is a precision devices.

To maintain the performance of the detector and improve the reliability of detecting leakage, perform a regular maintenance.

8-1. Maintenance intervals and items

Perform the following maintenance regularly before use.

- Daily maintenance: Perform maintenance before commencing each work.
- Monthly maintenance: Perform alarm test once a month.
- Regular maintenance: Perform maintenance once or more for one year to maintain the performance as a unit.

Maintenance item	Maintenance content	Daily maintenance	Monthly maintenance	Regular maintenance
Battery level check	Check that the battery level is sufficient.	○	○	○
Concentration display check	Make the detector draw in fresh air and check that the concentration display value is zero. When the reading is incorrect, perform zero adjustment by air calibration after ensuring that no other gases exist around it.	○	○	○
Flow rate check	Check the flow check display to find abnormalities.	○	○	○
Filter check	Check the dust filter for dust or clogging.	○	○	○
Gas alarm calibration	Check the gas alarm using a calibration gas.	-	-	○

About maintenance services

We provide services on regular maintenance including span adjustment, other adjustments and maintenance.

To make the calibration gas, dedicated tools, such as a gas cylinder of the specified concentration, gas sampling bag, etc., must be used.

Our qualified service engineers have expertise, knowledge and other information on the dedicated tools used for services, along with other products. To maintain the safety operation of the unit, please use our maintenance service.

The followings are typical maintenance services. For details, contact RIKEN KEIKI.

<Main Services>

Item	Services
Battery level check	Checks the battery level.
Concentration display check	Verifies that the concentration display value is zero by using the zero gas. Performs the air calibration if the reading is incorrect.
Flow rate check	Checks the flow rate indicator to find abnormalities. Checks the flow rate by using an external flow meter to verify the correctness of the flow rate indicator on the detector. If the flow rate is incorrect, performs the flow rate adjustment.
Filter check	Checks the dust filter for dust or clogging. Replaces a dirty or clogged dust filter.
Span adjustment	Performs span adjustment using a calibration gas.
Cleaning and repair of the unit (visual diagnosis)	Checks dust or damage on the surface of the unit, cleans and repairs such parts. Replaces parts which are cracked or damaged.
Unit operation check	Operates the buttons to check the operation of functions and parameters, etc.
Replacement of consumable parts	Replaces consumable parts, such as a sensor, filter, pump, etc.

8-2. How to clean

Clean the detector if it becomes extremely dirty. The detector must be turned off while cleaning it. Use a waste cloth or the like to remove dust. Do not use water or organic solvent for cleaning because they may cause malfunctions.

Because an extremely contaminated inside of the taper nozzle may disturb the gas detection, it must be cleaned with dry air, etc.



CAUTION

- When cleaning the detector, do not splash water over it or use organic solvents such as alcohol, benzene, etc. on it. Otherwise, it may cause discoloration or damage to the surface of the detector or a sensor failure.

NOTE

- When the detector gets wet, water may remain in the buzzer sound opening or grooves. Drain water as follows:
 - (1) Wipe away moisture on the detector thoroughly using a dry towel, cloth, etc.
 - (2) While holding the detector firmly, shake it about ten times with the buzzer sound opening facing downward.
 - (3) Wipe away moisture coming out from the inside thoroughly using a towel, cloth, etc.
 - (4) Place the detector on a dry towel, cloth, etc. and let it stand at normal temperatures.

8-3. Parts replacement

Filter replacement procedure

Continuing to use the detector may cause the filter to be contaminated or clogged.

Replace the filter if it becomes extremely dirty.

Also, replace the filter when it has absorbed water or has a lower flow rate.

- 1 Turn the cap counterclockwise and remove it.**



- 2 Remove the rubber seal from the cap.**



- 3 Replace the filter placed inside the rubber seal with a new one.**



- 4 Attach the rubber seal with the filter attached, to the cap.**

At this time, check that the rib has been firmly inserted into the groove.

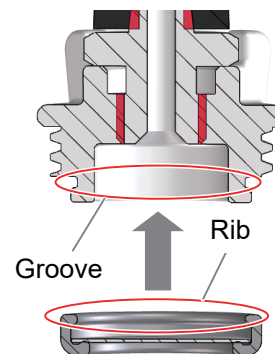

- 5 Attach the cap with the rubber seal attached, to the main unit.**

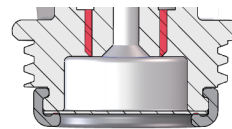

Interference gas removal filter (CF-8392) replacement procedure

The interference gas removal filter (CF-8392) is installed to the detector to remove interference gases that damage sensors for silicone, sulfides, etc.

Continuing to use the detector may cause the filter to be contaminated or clogged. Replace the filter when it has absorbed water or oil, etc. or has a lower flow rate due to clogging, or when the sensor sensitivity deteriorates significantly.

Install the filter by sliding the grooves on its sides to the guide of the case.

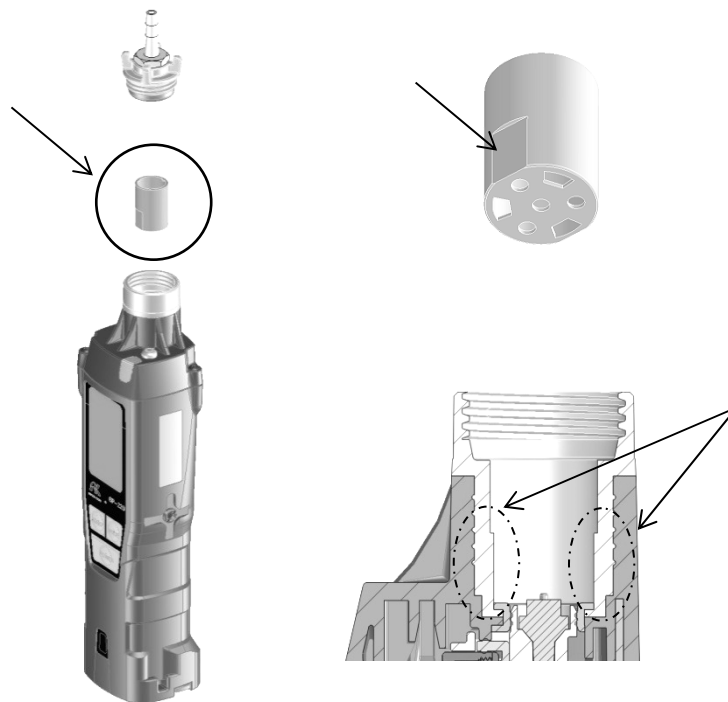

Sensor replacement

The built-in sensors of the detector have a validity period and must be replaced regularly (warranty period one year).

The sensor life has expired if, for example, the sensors cannot be calibrated in span adjustment, the readings do not come back after air calibration, or the readings fluctuate.

In this case, contact RIKEN KEIKI.

Battery replacement

For battery replacement, see "How to replace the batteries" on page 13.

9

Storage and Disposal

9-1. Procedures to store the detector or leave it for a long time

The detector must be stored under the following environmental conditions.

- In a dark place under the normal temperature and humidity away from direct sunlight
- In a place where gases, solvents, vapors, etc. are not present

Store the detector in a shipping carton, if any, in which the product was delivered.

Store the detector away from dust, etc. if the shipping carton is not available.



CAUTION

- If the detector is not used for a long time, store it after removing the batteries. Leaks from dry batteries may result in fire or injury.
- The detector, when not activated for a long time, may cease to work because of hardening of the grease in the pump motor.

9-2. Procedures to use the detector again



CAUTION

- When the detector is used again after a long-period storage, never fail to perform a calibration.
- Contact RIKEN KEIKI for information on readjustment including calibration.

9-3. Disposal of products

When the detector is disposed of, it must be treated properly as an industrial waste in accordance with the local regulations, etc.



WARNING

- Dispose of dry batteries in accordance with procedure specified by the local authority.

<Disposal in EU Member States>

When disposing of the detector in EU member states, sort the batteries as specified. Handle the removed batteries according to the classified refuse collection system and recycling system based on the regulations of EU member states.

Removing batteries

For battery removal, see "4-3. How to replace the batteries" on page 13.

NOTE

Crossed-out recycle dustbin mark

This symbol mark is indicated on the products which contain the batteries which fall under EU Battery Directive 2006/66/EC. Such batteries need to be disposed of as specified by the latest Directive. This symbol mark indicates that the batteries need to be separated from the ordinary waste and disposed of appropriately.



10

Troubleshooting

The Troubleshooting does not explain the causes of all the malfunctions which occur on the detector. This simply helps to find the causes of malfunctions which may frequently occur.

If the detector shows a symptom which is not explained in this manual, or still has malfunctions even though remedial actions are taken, please contact RIKEN KEIKI.

<Abnormalities on Unit>

Symptoms	Causes	Actions
The power cannot be turned on.	The battery level is too low.	Replace both of the two batteries with new ones.
	The POWER button was released quickly.	For power-on, keep the POWER button pressed until a blip is heard.
	Dry batteries are not installed properly.	Check that the batteries are properly installed to the main unit.
Abnormal operations	Disturbances by sudden static electricity noise, etc.	Turn off the power once and then turn it on again (restart).
Cannot operate the detector.	Disturbances by sudden static electricity noise, etc.	Remove the batteries in a safe place. Then reinstall them and turn on the power to perform operations.
System abnormalities FAIL SYSTEM	A circuit abnormality occurred.	Request RIKEN KEIKI for repair.
Sensor abnormalities FAIL SENSOR	A sensor has failed.	Remove the batteries in fresh air. Then reinstall them and turn on the power to perform operations. Restart the detector a few times. If the problem still persists, request RIKEN KEIKI to replace the sensor.
A low battery voltage alarm is displayed. FAIL BATTERY	The battery level is low.	Turn off the power and replace the dry batteries with new ones in a safe area.
A low flow rate alarm is displayed. FAIL LOW FLOW	Water, oil or the like is drawn.	Check the taper nozzle for any damage or mark of drawn water, oil, etc.
	The taper nozzle is clogged.	Check the taper nozzle for connection condition, clogging, torsion, etc.
	The detector was powered on at a low temperature or has not been used for a long time.	Cycle the power a few times. The pump may start operating. If the problem still persists, request RIKEN KEIKI to replace the pump.
	The pump has deteriorated.	Request the dealer or Riken Keiki local representative to replace the pump.

Symptoms	Causes	Actions
Air calibration impossible FAIL AIR CAL	Fresh air is not supplied around the detector.	Supply fresh air and then perform air calibration in the measured atmosphere.
Clock abnormalities FAIL CLOCK	Abnormalities of the internal clock	Make a setting of date/time. If such a symptom is observed repeatedly, the built-in clock is seemingly malfunctioning. Thus, it must be replaced. Request RIKEN KEIKI for repair.
Pump abnormalities FAIL PUMP	Abnormalities of the pump	Request RIKEN KEIKI for repair.

11

Product Specifications

Model	SP-220(TYPE M)	SP-220 (TYPE L)	SP-220 (TYPE ML)
Detection principle	Hot-wire semiconductor		
Gas to be detected	City gas (Switchable to LPG)	LPG (Switchable to city gas)	City gas/LPG (Switched)
Calibration gas	City gas (CH ₄) calibration	LPG (i-C ₄ H ₁₀) calibration	LPG (i-C ₄ H ₁₀) calibration City gas (CH ₄) calibration * Two-gas calibration
Concentration display	LCD bar meter + grid		
Detection range	10 - 10000 ppm		
Detection method	Pump suction type		
Alarm setpoint value	Default: 30 ppm (set one of five levels: 10, 30, 150, 500 and 2000 ppm)		
Displays	Operating state display, flow check display, alarm sound display, operation sound display, battery level display, bar meter display, mode display, gas name and message display		
Response time (under the same conditions)	3 seconds or less		
Gas alarm type	One-step alarm		
Gas alarm display	Lamp blinking/buzzer sounding		
Gas alarm pattern	Non latching (auto-reset)		
Fault alarm	Sensor abnormality/low flow rate/battery voltage low/system abnormality/calibration abnormality/clock abnormality/pump abnormality		
Fault alarm display	Lamp blinking/buzzer sounding/fault detail display		
Fault alarm pattern	Self-latching		
Power supply	AA alkaline battery x 2		
Continuous operating time	Approx. 13 hours (alkaline batteries, at 20°C, without alarms or lighting)		
Operating temperature range	-20 - +55°C		
Operating humidity range	95% RH or less (Non-condensing)		
Explosion-proof structure	Intrinsically safe explosion-proof structure		
Explosion-proof class	II1G Ex ia IIC T4 Ga(ATEX/UKEX) Ex ia IIC T4 Ga(IECEX) Ex ia IIC T4(Japan Ex)		
Protection class	Equivalent to IP-55		
External dimensions	Approx. 43 (W) x 200 (H) x 39 (D) mm (projection portions excluded)		
Weight	Approx. 215 g (without batteries)		

* The gas concentration is only approximate because the detector is designed to be used to detect a small amount of gas leakage.

12

Appendix

12-1. Definition of terms

vol%	Gas concentration indicated in the unit of one-hundredth of the volume
ppm	Gas concentration indicated in the unit of one-millionth of the volume
LEL	The acronym of Lower Explosive Limit. Lower explosive limit (LEL) refers to the lowest concentration of a combustible gas in air capable of causing explosion when ignited.



EU-Declaration of Conformity

Document No.: 320CE22074



We, RIKEN KEIKI Co., Ltd. 2-7-6, Azusawa, Itabashi-ku, Tokyo, 174-8744 Japan declare under our sole responsibility that the following product conforms to all the relevant provisions.

Product Name: Portable Gas Leak Detector
Model: SP-220(TYPE M), SP-220(TYPE L),
SP-220(TYPE ML), SP-220(TYPE F),
SP-220(TYPE H2)

Council Directives		Applicable Standards
2014/30/EU	EMC Directive	EN 50270:2015
2014/34/EU	ATEX Directive	EN IEC 60079-0:2018 EN 60079-11:2012
2011/65/EU ^[1]	RoHS Directive	EN IEC 63000:2018

^[1]Including substances added by Commission Delegated Directive (EU) 2015/863

EU-Type examination Certificate No.

Presafe 15 ATEX 7188X

Notified Body for ATEX

DNV Product Assurance AS (NB 2460)
Veritasveien 1
1363 Høvik
Norway

Auditing Organization for ATEX

DNV Product Assurance AS (NB 2460)
Veritasveien 1
1363 Høvik
Norway

The marking of the product shall include the following:

 II 1 G Ex ia IIC T4 Ga

Place: Tokyo, Japan

Date: Jun. 29, 2022

Takakura Toshiyuki
General manager
Quality Control Center



UK-Declaration of Conformity

Document No.: 320UK22041



We, RIKEN KEIKI Co., Ltd. 2-7-6, Azusawa, Itabashi-ku, Tokyo, 174-8744, Japan declare under our sole responsibility that the following product conforms to all the relevant provisions.

Product Name: Portable Gas Leak Detector
Model: SP-220(TYPE M), SP-220(TYPE L),
SP-220(TYPE ML), SP-220(TYPE F),
SP-220(TYPE H2)

Regulations	UK designated Standards
Electromagnetic Compatibility Regulations 2016 (S.I. 2016/1091)	BS EN 50270:2015
The Equipment and Protective Systems Intended for Use in Potentially Explosive Atmospheres Regulations 2016 (S.I. 2016/1107) (UKEX)	BS EN IEC 60079-0:2018 BS EN 60079-11:2012
The Restriction of the Use of Certain Hazardous Substances in Electrical and Electronic Equipment Regulations 2012 (S.I. 2012/3032)	BS EN IEC 63000:2018

UK-Type examination Certificate No.

DNV 22 UKEX 25920X

Approved Body for UKEX

DNV Business Assurance UK Ltd (AB8501)
4th Floor Vivo Building, 30 Stamford Street,
London SE1 9LQ, United Kingdom

Auditing Organization for UKEX

DNV Business Assurance UK Ltd (AB8501)
4th Floor Vivo Building, 30 Stamford Street,
London SE1 9LQ, United Kingdom

The marking of the product shall include the following:

 II 1 G Ex ia IIC T4 Ga -20°C≤Ta≤+55°C

Place: Tokyo, Japan

Date: Nov. 18, 2022

Takakura Toshiyuki
General manager
Quality Control Center