



PT0E-1427

Portable Gas Leak Detector

SP-220 Series

SP-220(TYPE FUM)

SP-220(TYPE SC)

Operating Manual

RIKEN KEIKI Co.,Ltd.

2-7-6 Azusawa, Itabashi-ku, Tokyo, 174-8744, Japan

Phone : +81-3-3966-1113

Fax : +81-3-3558-9110

E-mail : intdept@rikenkeiki.co.jp

Web site : <https://www.rikenkeiki.co.jp/english/>

Contents

1. Outline of the Product.....	3
Preface.....	3
Purpose of use.....	3
Definition of DANGER, WARNING, CAUTION and NOTE.....	3
Method of confirmation for CE/UKCA marking type.....	4
2. Important Notices on Safety.....	5
2-1. Danger cases.....	5
2-2. Warning cases.....	6
2-3. Precautions.....	7
3. Product Components.....	9
3-1. Names and functions for each part.....	9
4. How to Use.....	12
4-1. Before using the detector.....	12
4-2. Preparation for start-up.....	12
4-3. How to replace the batteries.....	12
4-4. How to start the detector.....	14
4-5. Basic operating procedures.....	16
4-6. How to detect.....	17
4-7. Change of the concentration measuring mode.....	18
4-8. Perform air calibration.....	21
4-9. Snap logger.....	22
4-10. Peak hold function.....	24
4-11. Change of the alarm and operation sounds.....	24
4-12. How to turn on the illumination lamp.....	25
4-13. Power-off.....	25
5. How to Set Display Mode.....	26
5-1. Entering the display mode.....	26
5-2. Concentration displayed gas reading setting.....	29
5-3. Change of the measuring mode (only for fumigation gases).....	33
5-4. Log data display.....	34
6. How to Set User Mode.....	35
6-1. Entering the user mode.....	35
6-2. Date/time setting.....	37
6-3. Clock function ON/OFF setting.....	38
7. Alarm function.....	39
7-1. Gas alarm activation.....	39
7-2. Fault alarm activation.....	39
8. Maintenance.....	40
8-1. Maintenance intervals and items.....	40
8-2. How to clean.....	42
8-3. Parts replacement.....	42
9. Storage and Disposal.....	44
9-1. Procedures to store the detector or leave it for a long time.....	44
9-2. Procedures to use the detector again.....	44
9-3. Disposal of products.....	44
10. Troubleshooting.....	46
11. Product Specifications.....	48
12. Appendix.....	49
12-1. Definition of terms.....	49

1

Outline of the Product

Preface

Thank you for choosing our gas leak detector SP-220 series (hereinafter referred to as the detector). Please check that the model number of the product you purchased is included in the specifications on this manual.

This manual explains how to use the gas detector and its specifications. It contains information required for using the detector properly. Not only the first-time users but also the users who have already used the product must read and understand the operating manual to enhance the knowledge and experience before using the detector.

Note that the contents of this manual are subject to change without notice for product improvement. It is also prohibited to copy or reproduce this manual, in whole or in part, without permission.

Regardless of warranty period, we shall not make any indemnification for accidents and damage caused by using the detector.

Make sure to read the warranty policy specified on the warranty.

Purpose of use



This detector is used to detect a single channel, such as hydrogen phosphide (phosphine: PH₃), etc., in air.

It provides two different specifications : TYPE FUM used to detect leakage of fumigation gases and TYPE SC used to detect leaking of general gases including semiconductor material gases.

Detection results are not intended to guarantee life or safety in any way.

Definition of DANGER, WARNING, CAUTION and NOTE

Throughout this manual, the following indications are used to ensure safe and effective work.

 DANGER	This message indicates that improper handling may cause serious damage on life, health or assets.
 WARNING	This message indicates that improper handling may cause serious damage on health or assets.
 CAUTION	This message indicates that improper handling may cause minor damage on health or assets.
NOTE	This message indicates advice on handling.

Method of confirmation for CE/UKCA marking type

The CE/UKCA marking is labeled on the detector in case of comply with CE/UKCA mark. Please confirm the instrument specification before using. Please refer Declaration of Conformity that is at the end of this manual if you have CE/UKCA marking type.

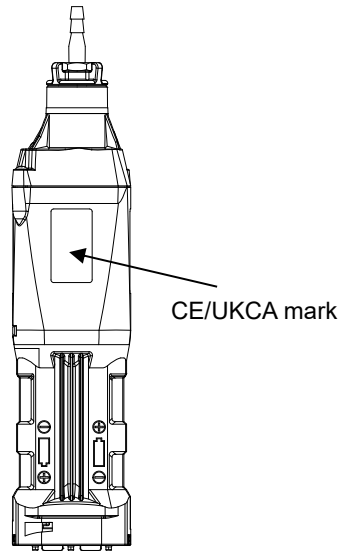

CE/UKCA mark label

2

Important Notices on Safety

To maintain the performance and use the gas detector safely, observe the following instructions of DANGER, WARNING and CAUTION.

2-1. Danger cases



DANGER

About use

- This is not an explosion-proof detector. You must not use it to detect gases exceeding the lower explosive limit (LEL).
- While conducting measurement in a manhole or confined space, do not lean over or look into the manhole or closed space. It may lead to dangers because oxygen-deficient air or other gases may blow out.
- Oxygen-deficient air or other gases may be discharged from the gas exhausting outlet of the detector. Never inhale the air or gases.
- High-concentration (100% LEL or higher) gases may be discharged from the gas exhausting outlet of the detector. Never use fire near it.

2-2. Warning cases



WARNING

Sampling point pressure

- The concentration meter is designed to draw gases under the atmospheric pressure. If excessive pressure is applied to the gas inlet and outlet of the detector, measured gases may leak out from its inside and may cause dangerous conditions. Be sure that excessive pressure is not applied to them while used.

Air calibration in atmosphere

- When air calibration is performed in the atmosphere, check the atmosphere for freshness before beginning it. If interference gases exist, the adjustment cannot be performed properly, thus leading to dangers when the gas leaks.

Response to gas alarm

- A gas alarm is triggered by changes in temperature and humidity. In such a case, check the atmosphere for freshness and perform air calibration again in the measured atmosphere. Example) If the detector is turned on in a room with a temperature of 20°C and a humidity of 40% RH and taken outside (a temperature of 30°C and a humidity of 60% RH), an alarm is triggered by humidity changes. In such a case, perform air calibration outside and measure. The detector performs air calibration automatically when it is turned on. Even in such a case, check the atmosphere for freshness and perform air calibration again in the measured atmosphere.



WARNING

Battery level check

- Before use, check that there remains sufficient battery power. When the detector is not used for a long period, the batteries may be exhausted. Never fail to replace them with new ones before use.
- If a low battery voltage alarm is triggered, gas detection cannot be conducted. If the alarm is triggered during use, turn off the power and promptly replace the batteries in a safe area.

Others

- Do not throw the detector into fire.
- Do not wash the detector in a washing machine or ultrasonic cleaner.
- Do not block the buzzer sound opening. No alarm sound can be heard.
- Do not remove the battery while the power is on.

2-3. Precautions



CAUTION

Do not use the gas detector where it is exposed to oil, chemicals, etc. Do not submerge the detector under water on purpose.

- Do not use in a place where the detector is exposed to liquids such as oil, chemicals, etc.
- The detector is not water-pressure-resistant. Do not use the detector where a high water pressure is applied to it (under a faucet, shower, etc.) or submerge it under water for a long time. The detector is water-proof only in fresh water and running water, and not in hot water, salt water, detergent, chemicals, human sweat, etc.
- The gas inlet and outlet are not water-proof. Be careful not to let water such as rainwater, etc. get into these parts. Because this may cause trouble and gas cannot be detected.
- Do not place the detector where water or dirt gets accumulated. The detector placed at such a location may cause malfunction due to water or dirt that gets into the buzzer opening, etc.
- Note that drawing in dirty water, dust, metallic powder, etc. will significantly deteriorate the sensor sensitivities. Be careful when the detector is used in an environment where these elements exist.

Do not use the detector in a place where the temperature drops below -20°C or rises over 55°C.

- The operating temperature of the detector is -20 to +55°C. Do not use the detector at higher temperatures, humidities and pressures or at lower temperatures than the operating range.
- Avoid long-term use of the detector in a place where it is exposed to direct sunlight.
- Do not store the detector in a sun-heated car.
- Avoid a sudden humidity or temperature change.
- Do not leave the detector in a place with high temperature and humidity for a long time. The performance of the detector may deteriorate.

Observe the operating restrictions to prevent condensation inside the concentration meter or gas sampling hose.

- Condensation formed on the detector or taper nozzle causes clogging or gas adsorption, which may disturb accurate gas detection. Thus, condensation must be avoided. In addition to the installation environment, carefully monitor the temperature/humidity of the sampling point to prevent condensation on the detector or taper nozzle. Please observe the operating restrictions.

Do not use a transceiver near the detector.

- Radio wave from a transceiver near the detector may disturb readings. If a transceiver or other radio wave transmitting device is used, it must be used in a place where it disturbs nothing.
- Do not use the detector near a device that emits strong electromagnetic waves (high-frequency or high-voltage devices).

Verify that the flow check display is rotating before using the detector

- If the pump driving indicator is not rotating, gas cannot be measured properly. Check whether the flow rate is lost.

Never fail to perform a regular maintenance.

- Since this is a precision devices, a regular maintenance must be performed. Continuing to use the detector without performing maintenance will compromise the sensitivity of the sensor, thus resulting in inaccurate gas detection.



CAUTION

Others

- Exposing the sensor to a gas for a long time or a high-concentration gas may result in that the gas alarm will remain for a certain period. If the exposure occurs, allow the instrument to draw fresh air for more than 5 minutes (recommendation), and then perform air calibration again.
- Pressing buttons unnecessarily may change the settings, preventing alarms from activating correctly. Operate the detector using only the procedures described in this operating manual.
- Do not drop or give shock to the detector. The accuracy of the gas detector may be deteriorated.
- Do not jab the buzzer opening with a sharp-pointed item. Doing so may cause a failure or damage.
- Do not remove the panel sheet on the display. The water-proof and dust-proof performances will be deteriorated.
- Do not affix a label or the like on the infrared port. Infrared communications can no longer be conducted.
- The operating environment may include gases that have harmful effects on the sensor of the detector. The detector cannot be used in the presence of the following gases:
 - (1) High-concentration sulfides (such as H₂S, SO₂, etc.)
 - (2) Halogen gases (such as chloride compounds, etc.)
 - (3) Silicone (Si compounds)
 - (4) High-concentration solvent gases

Do not use the detector in the presence of the above (1), (2), and (3) gases (such as high-concentration sulfides, halogen gases, silicone, etc.), which may shorten the sensor life significantly or cause malfunctions such as inaccurate readings.

In case the gas detector is used for detection in the presence of silicone, etc., be sure to check the gas sensitivities before using it again.

If the above (4) gas (high-concentration solvent gas) is exposed, a crack may occur in the detector. Thus, do not use high-concentration solvent gases.

About battery replacement

- Never fail to turn off the power of the detector before replacing the batteries.
- Replace both of the two batteries with new ones at one time.
- Pay attention to the polarities of the batteries.

Usage

- In a low-temperature environment, the operating time is shortened due to the battery performance property.
- At low temperatures, the responses of the LCD display may slow down.
- Perform air calibration under pressure and temperature/humidity conditions close to those in the operating environment and in fresh air.
- Perform air calibration after the reading is stabilized.
- If there is a sudden temperature change of 15°C or more between the storage and operational locations, turn on the power of the gas detector, let it stand for about 10 minutes in a similar environment to the operational location, and perform air calibration in fresh air before using it.
- When cleaning the gas detector, do not splash water over it or use organic solvents such as alcohol and benzene on it. The surface of the gas detector may be discolored or damaged.
- If the gas detector is not used for a long time, turn on the power at least once every six months and check that the pump draws in air (about three minutes). The gas detector, when not activated for a long time, may cease to work because of hardening of the grease in the pump motor.
- If the gas detector is not used for a long time, store it after removing the batteries. Battery leaks may result in fire, injury, etc.
- When the detector is used again after a long-period storage, never fail to perform air calibration. For information on readjustment including air calibration, please contact RIKEN KEIKI.

3

Product Components

3-1. Names and functions for each part

This section describes names and functions of main unit and battery unit parts and LCD display.

Main unit

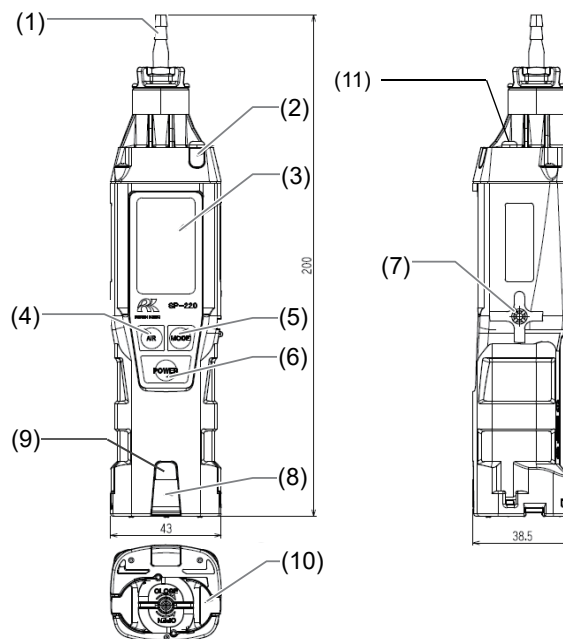

No.	Name	Function
(1)	Gas inlet	Collects gases.
(2)	Alarm LED arrays	Blinks or lights up in response to an alarm.
(3)	LCD display	Displays gas concentrations, measured gas name, alarms, etc.
(4)	AIR button	Keep this button pressed to perform air calibration. Used to change the screen and increase numerical values in the setting mode.
(5)	MODE button	Press this button to change between display modes. Used to change the screen and increase numerical values in the setting mode.
(6)	POWER button	Turns the power ON or OFF. Used to change the screen and confirm values in the setting mode.
(7)	Gas outlet	Exhausts the gas drawn into the detector. (Do not block it.)
(8)	Alarm LED arrays	Blinks or lights up in response to an alarm.
(9)	Infrared port	Used during infrared communications.
(10)	Battery cover	Protects the battery. Remove it to replace the batteries.
(11)	LED light	Provides you light for work.

Standard accessories

Unpack and check the main unit and accessories.

- AA alkaline battery (2 pcs) (installed)
- Taper nozzle (1 pc)
- Rubber protection cover (1 pc) (Protect the detector from shocks by being hit, etc.)
- Hand strap (1 pc)
- Waterproofing filter for exchange(5 pcs)
- Product warranty (English) (1 pc)
- Product warranty (Japanese) (1 pc)
- Operating manual (English) (1 pc)
- Operating manual (Japanese) (1 pc)

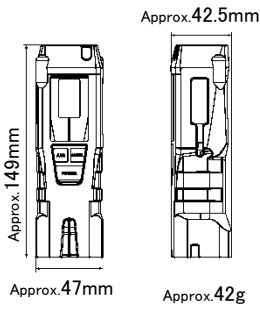
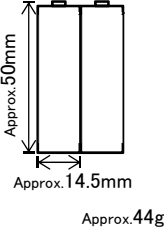
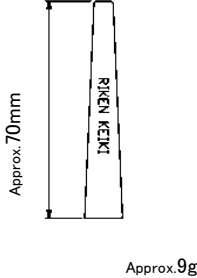
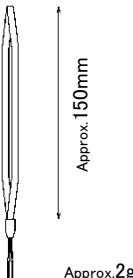
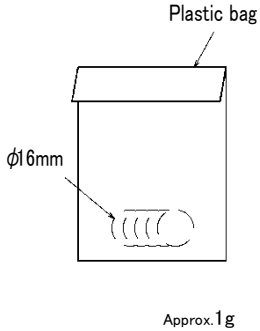
Name	Appearance and amount	Quantity	Name	Appearance and amount	Quantity
Rubber protection cover		1 pc (attached)	AA alkaline battery		2 pcs (installed)
Taper nozzle		1pc	Hand strap		1pc
Water-proofing filter for exchange		5pcs	Operating manual (English)	—	1pc
			Operating manual (Japanese)	—	1pc
			Product warranty (English)	—	1pc
			Product warranty (Japanese)	—	1pc

If there is anything missing, contact RIKEN KEIKI.



CAUTION

- Do not remove the panel sheet on the display. The water-proof and dust-proof performances will be deteriorated.
- Do not affix a label or the like on the infrared port. Infrared communications can no longer be conducted.

LCD display

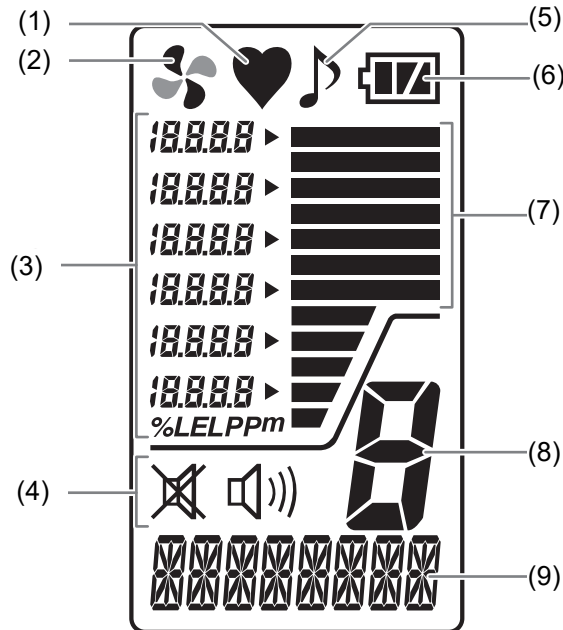

No.	Name	Function
(1)	Operating state display	Displays the operating status in the detection mode. Normal: Blinking
(2)	Flow check display	Displays the drawing status. Normal: Rotating
(3)	Gas concentration display	Displays gas concentration and unit.
(4)	Alarm sound display	Displays the setting status of the alarm sound.
(5)	Operation sound display	Displays the setting status of the operation sound.
(6)	Battery level icon	Displays a reference of the battery level.
(7)	Bar meter display	Displays the level of gas concentration with the bar meter
(8)	Mode display	Displays the measuring mode status.
(9)	Gas name and message display	Displays the gas name and a message according to the function.

NOTE

- The meanings of battery level icons are as follows:

 :Sufficient /
  :Low /
  :Needs replacing the batteries

If the battery level further drops, the inside of the battery icon starts to blink ().

4

How to Use

4-1. Before using the detector

Not only the first-time users but also the users who have already used the detector must follow the operating precautions. Ignoring the precautions may damage the unit, resulting in inaccurate gas measurement.

4-2. Preparation for start-up

Before use, read and understand the following precautions. Ignoring these may cause inaccurate gas detection.

- The batteries are installed (with sufficient battery level).
- Check that the taper nozzle and filter are not contaminated.
- Check that the taper nozzle is not bent or has no hole.
- Check that the nipple to which the taper nozzle is attached is not loose.

4-3. How to replace the batteries

When the detector is used for the first time, or when the battery level is low, attach two new AA alkaline batteries according to the following procedures.

- 1 Check that the power of the detector is turned off.**
Turn off the power if it is turned on.
- 2 Turn the lock plate counterclockwise and open the battery cover.**
- 3 Remove old batteries and then put new batteries while observing the correct polarity.**
- 4 Close the battery cover and turn the lock plate clockwise to lock.**

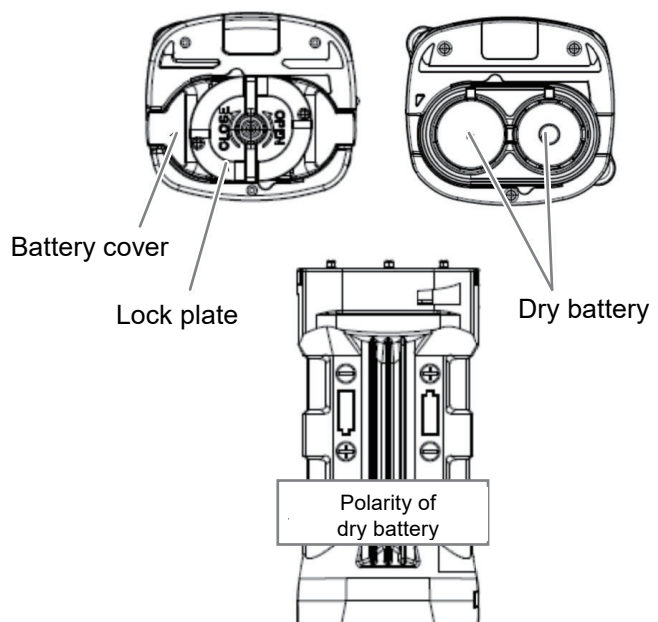

**CAUTION**

- Never fail to turn off the power of the detector before replacing the batteries.
- Replace the batteries in a safe place.
- Replace both of the two batteries with new ones at one time.
- Pay attention to the polarities during replacement. Replace while checking the battery polarities stamped on the body.
- If the battery cover is not completely locked, the dry batteries may drop off or water may get in through the clearance. Water may also get in if a minute foreign substance is caught between the detector and battery cover.

4-4. How to start the detector

When the power is turned on, a self-diagnostic starts, and then the detector enters the detection mode.

Power-on

Press and hold the **POWER** button until the buzzer blips (one second or longer) to turn on the power. When the power is turned on, the LCD display changes automatically as shown below, and the detector enters the detection mode.

(Display example: For fumigation gases)

- 1 Press and hold the **POWER** button for one second or longer.**
Hold it down until all the LCDs and alarm lamp light up and the buzzer blips.

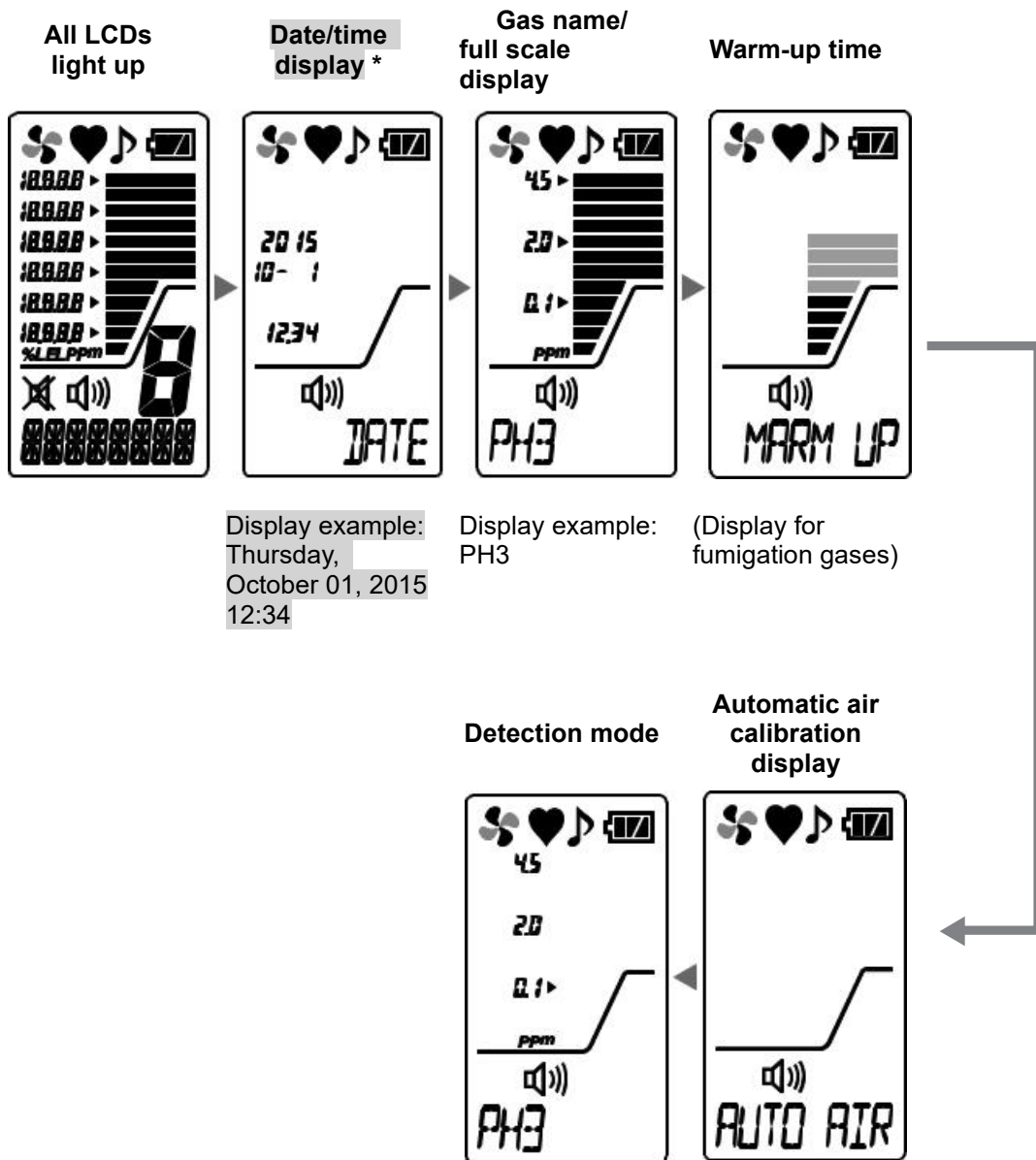

The buzzer blips once and the detection mode is displayed.

- * The date/time display is displayed only when the clock function is enabled. It is not displayed because the clock function is disabled by default.
To enable the clock function, see "6-3. Clock function ON/OFF setting" on page 38.

NOTE

- When powering on after leaving the detector for more than five minutes with the batteries removed, such as when powering on for the first time, replacing the batteries, etc., or powering on with the batteries inserted with incorrect polarities, a clock abnormality (FAIL CLOCK) may be triggered. When it is reset using the MODE button, the detector moves to the date/time setting screen. See "6-2. Date/time setting" on page 35 and set the date/time.
- Warm-up time (WARM UP) is different depending on the stability status of the sensor.
- If the detector is not used for a long period, warm-up time may be longer or a sensor abnormality (FAIL SENSOR) may be displayed. In such a case, restart the detector.
- The detector performs air calibration automatically on start-up. If an environment where the detector is turned on is different from the measured atmosphere, perform air calibration again in the measured atmosphere.

About LCD backlight

- Pressing the **AIR**, **MODE** or **POWER** button turns on the LCD backlight. The LCD backlight goes off after 30 seconds or so of no operation.
When an alarm is triggered, the LCD backlight lights up automatically.
-

4-5. Basic operating procedures

The detection mode is used after power-on.
 (Display example: For fumigation gases)

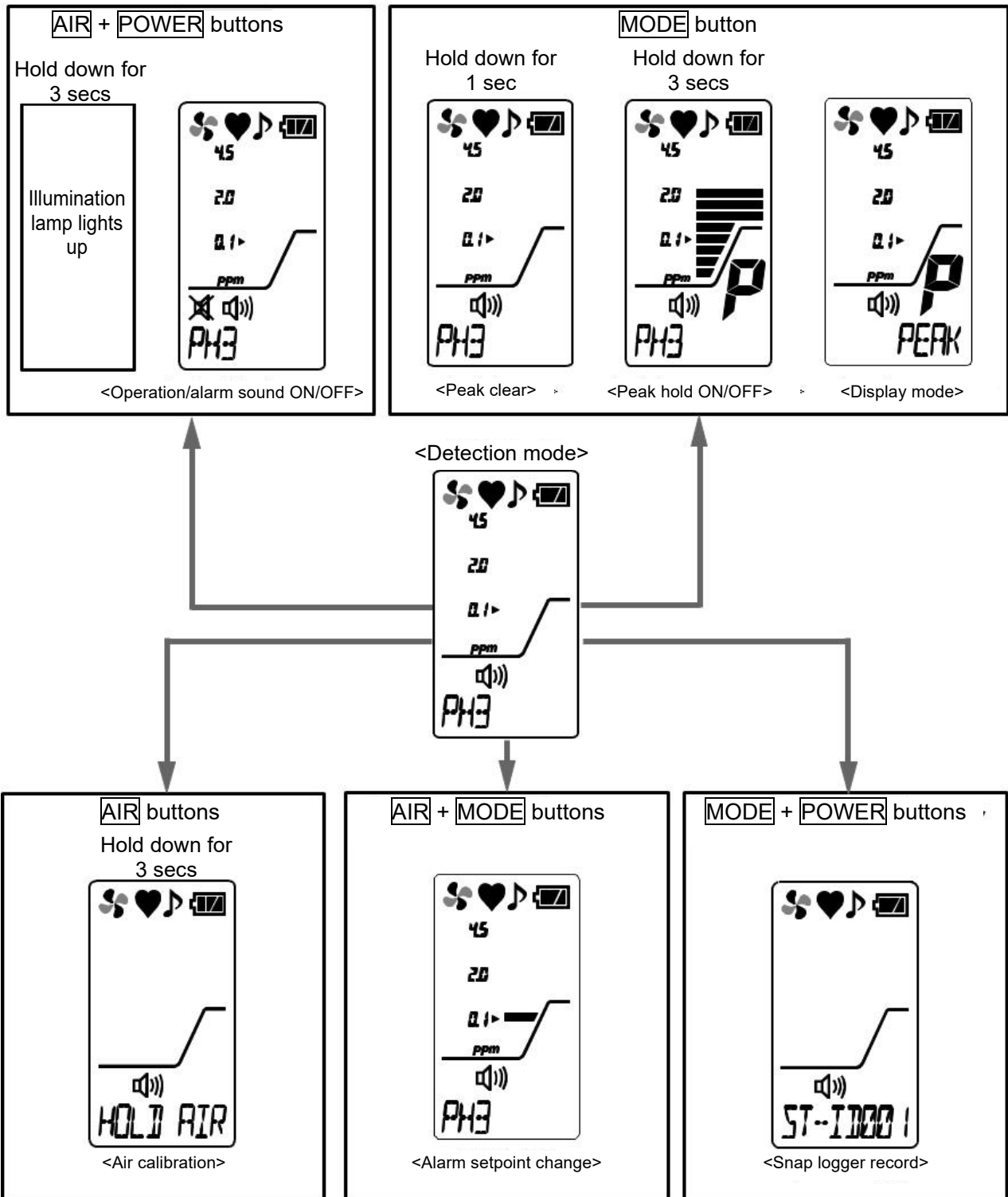

* Displayed only when the clock function is enabled. See "6-3. Clock function ON/OFF setting" on page 36.

4-6. How to detect

Put the tip of the taper nozzle close to the detection area in the detection mode and perform gas detection.

If a gas is drawn, the detected gas concentration is displayed with the bar meter on the LCD display.



DANGER

- While conducting measurement in a manhole or confined space, do not lean over or look into the manhole or closed space. It may lead to dangers because oxygen-deficient air or other gases may blow out.
- Oxygen-deficient air or other gases may be discharged from the gas exhausting outlet of the detector. Never inhale the air or gases.
- High-concentration (100% LEL or higher) combustible gases may be discharged from the gas exhausting outlet of the detector. Never use fire near it.



WARNING

- The detector is designed to draw gases around it under the atmospheric pressure. If excessive pressure is applied to the gas inlet and outlet of the detector, detected gases may leak out from its inside and may cause dangerous conditions. Be sure that excessive pressure is not applied to the detector while used.
- When air calibration is performed in the atmosphere, check the atmosphere for freshness before beginning it. If interference gases exist, the adjustment cannot be performed properly, thus leading to dangers when the gas leaks.
- Issuance of a gas alarm indicates that there are extreme dangers. Take proper actions based on your judgment.
- Before use, check that there remains sufficient battery power. When the detector is not used for a long period, the batteries may be exhausted. Never fail to replace them with new ones before use.
- If a low battery alarm occurs, gas detection cannot be conducted. If the alarm is triggered during use, turn off the power and promptly replace the batteries in a safe area.
- Do not block the buzzer sound opening. No alarm sound can be heard.
- If the main unit is dropped or given a shock, the reading may rise and it may remain so. In such a case, perform air calibration in a place where the surrounding air is fresh.



CAUTION

- Before performing gas detection, attach the taper nozzle provided with the detector to prevent disturbances by air dust.

4-7. Change of the concentration measuring mode

In the detector, the detection gas type is factory set to PH3 (phosphine) and the alarm setpoint is factory set to 0.1.

The alarm setpoint mode can be changed, depending on the gas to be detected, in three levels for fumigation gases and two levels for semiconductor material gases.

For the concentration measuring for fumigation gases, the concentration measuring mode or differential measuring mode can be selected.

In the differential measuring mode, "LOW MODE" and "HIGH MODE" can be switched.

<Concentration measuring mode>

Perform air calibration in the atmosphere.

Then, the mode monitors changes to the air value, showing the correlation between a leakage amount and the bar display.

(If the measured atmosphere changes, perform air calibration again.)

<Differential measuring mode>

Perform automatic air calibration at regular intervals in the atmosphere of measurement environment. This is a high sensitivity mode that enables detection of ultralow amount of leaking gas in the air by eliminating the environmental effects (other gases, temperature and humidity). Since it can detect a slight amount of increase in gas concentration even in the environment where a gas is leaking already, this measuring mode is effective to identify a leaking point.

Gas alarm setpoint for concentration measuring mode (for fumigation gases)

- 1 In the detection mode, press the **AIR** and **MODE** buttons at the same time.

The alarm setpoint changes by three every time the **AIR** and **MODE** buttons are pressed.

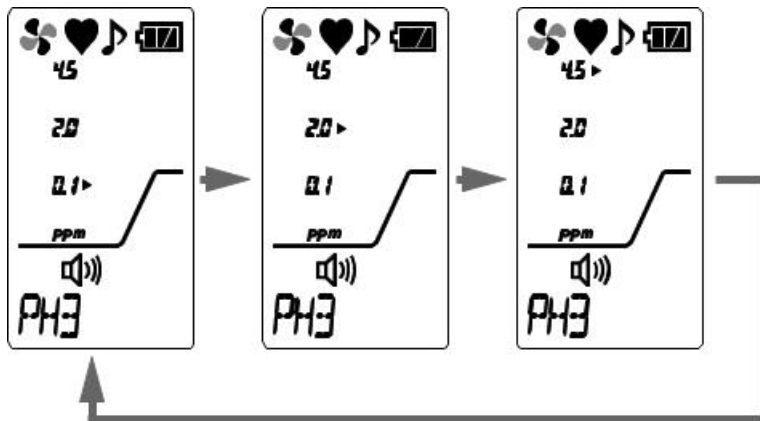

Gas alarm setpoint for concentration measuring mode (for semiconductor material gases)

- In the detection mode, press the **AIR** and **MODE** buttons at the same time. The alarm setpoint changes by two every time the **AIR** and **MODE** buttons are pressed.

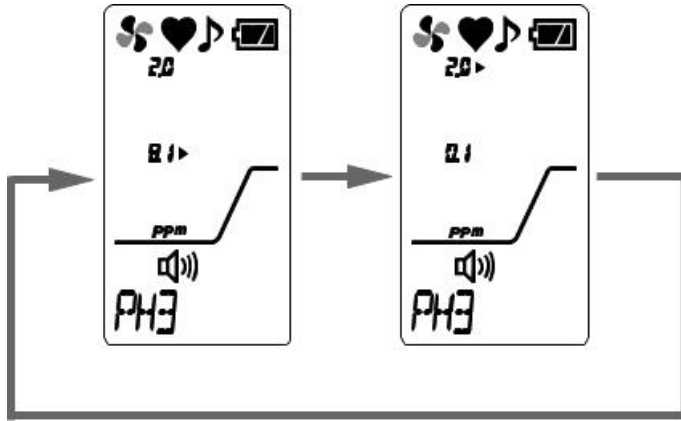

Gas alarm setpoint for differential measuring mode (only for fumigation gases)

- In the detection mode, press the **AIR** and **MODE** buttons at the same time. The alarm setpoint changes in six steps every time the **AIR** and **MODE** buttons are pressed.

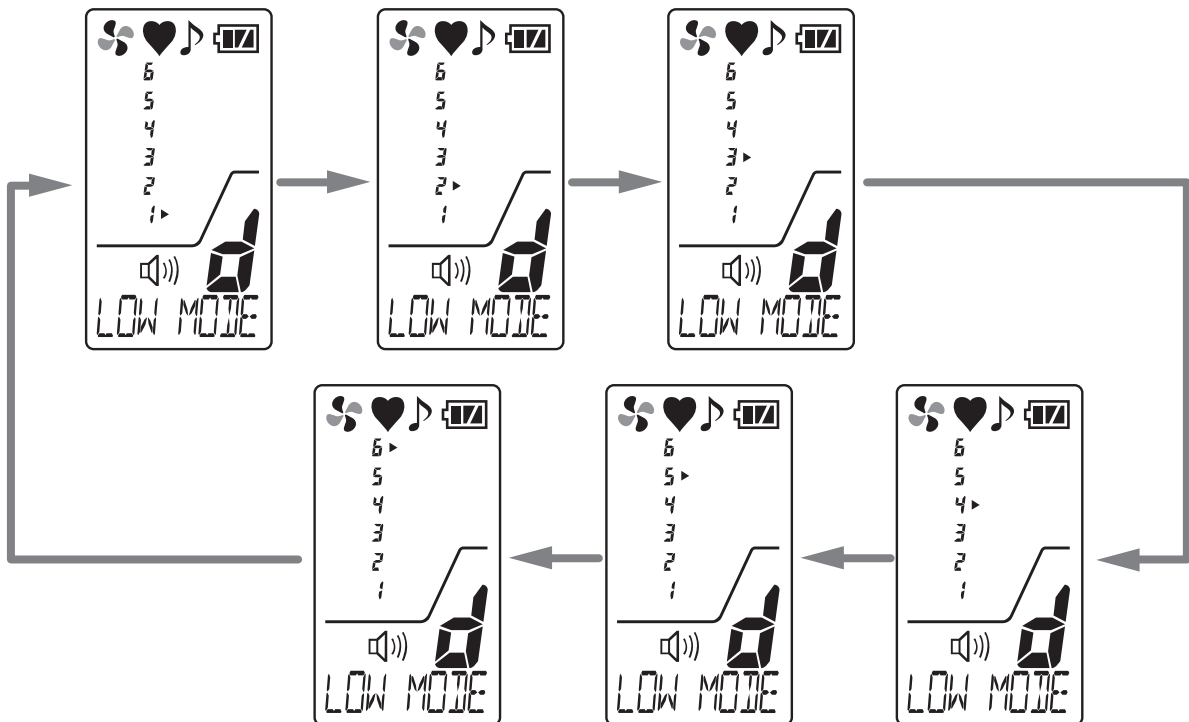

Change of gas alarm sensitivity for differential measuring mode (only for fumigation gases)

1 In the detection mode, press the **AIR** button.

The alarm sensitivity changes by two every time the **AIR** button is pressed.

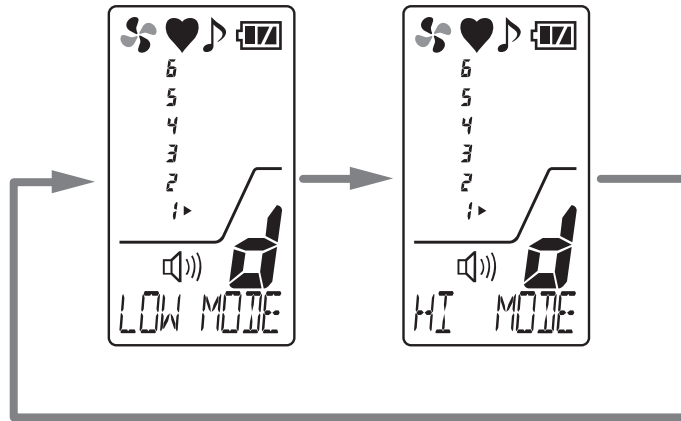

CAUTION

- Keeping contact with a gas with the same concentration will decrease the bar meter by the automatic air calibration function.
- For excessive temperature/humidity changes, the bar meter may increase.
- When the mode is switched from the differential mode to the concentration measuring mode, check the atmosphere for freshness and perform air calibration again in the measured atmosphere.
- The gas concentration is displayed in six levels (without a unit).
- Air calibration is performed automatically and it cannot be performed manually.

NOTE

- For switching to the differential measuring mode (for fumigation gases), see "Change of the measuring mode" in the display mode on page 33.

4-8. Perform air calibration

After a high-concentration gas is detected or an alarm is triggered by temperature/humidity changes, perform air calibration in the measured atmosphere.

* Before performing air calibration, check that the surrounding air is fresh.
(Display example: For fumigation gases)

- 1 In the detection mode, hold down the AIR button.**

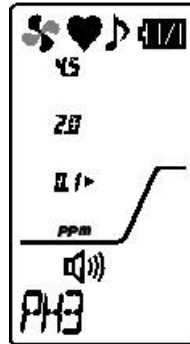

(Display for fumigation gases)

- 2 Release the AIR button when the display changes from "HOLD AIR" to "RELEASE".**

(Buzzer sound: Three times <blip, blip, blip >)

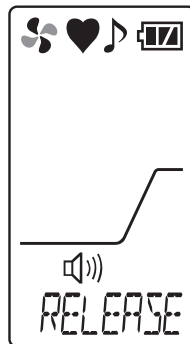
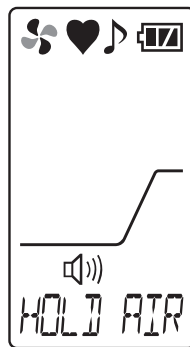

The air calibration is done and the gas detector returns to detection mode.
(Buzzer sound: Once <blip>)

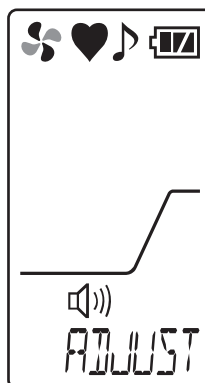

If air calibration fails, "FAIL AIR CAL" is displayed. Perform air calibration again in fresh surrounding air.

NOTE

- Perform air calibration under pressure and temperature/humidity conditions close to those in the operating environment and in fresh air.
- Perform air calibration after the reading is stabilized.
- If there is a sudden temperature change between the storage and operational locations, turn on the power of the detector, let it stand for ten minutes or more in a similar environment to the operational location, and perform air calibration in fresh air before using it.

4-9. Snap logger

Any peak value during measurement can be recorded.

Up to 256 points of data can be recorded. When the number of recorded data points reaches the maximum, recorded data will be overwritten, starting from the oldest data.

This function is enabled when the clock function is enabled. Since the clock function is disabled by default, enable it before using the snap logger function (See "6-3. Clock function ON/OFF setting" on page 38).

- 1 In the detection mode, press the **MODE** and **POWER** buttons at the same time.**

The detector enters the station ID selection screen.

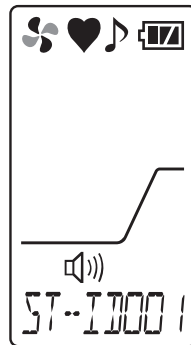

- 2 Use the **MODE** or **AIR** button to select the station ID and press the **POWER** button.**

The peak value is displayed.

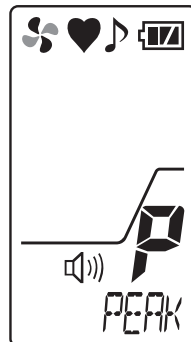

To stop recording, press the **AIR** and **MODE** buttons at the same time. The detector returns to the detection mode.

- 3 Press the **POWER** button.**

The date/time and peak value are recorded.

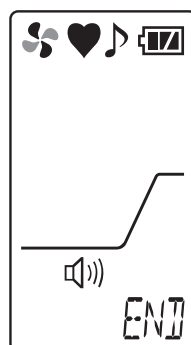

To continue recording the log, repeat steps 2 to 3.

To stop recording the log, press the **AIR** and **MODE** buttons at the same time. The detector returns to the detection mode.

NOTE

- The recorded data can be read out by the "Data Logger Management Program" (optional). See the operating manual of "Data Logger Management Program" for more information.
-

4-10. Peak hold function

When the peak hold function is enabled, the latest peak value is always displayed with the bar meter. (Display example: For fumigation gases)

- In the detection mode, hold down the **MODE** button (for three seconds or longer).**
The peak hold function is enabled. While the peak hold function is enabled, "P" is displayed on the LCD display.

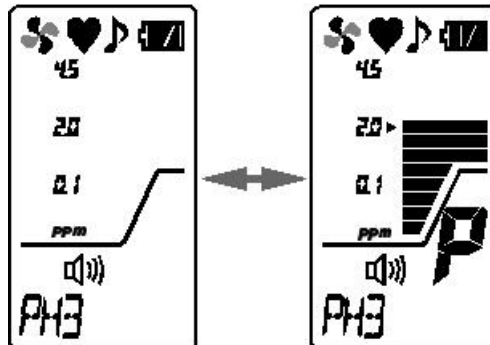

To disable the peak hold function, hold down the **MODE** button for three seconds or longer.

NOTE

- To clear a retained peak value, hold down the **MODE** button in the detection mode (for one second).

4-11. Change of the alarm and operation sounds

Turn the alarm and operation sounds ON or OFF. (Display example: For fumigation gases)

- In the detection mode, press the **AIR** and **POWER** buttons at the same time.**
The settings for the alarm and operation sounds are switched every time the **AIR** and **POWER** buttons are pressed.

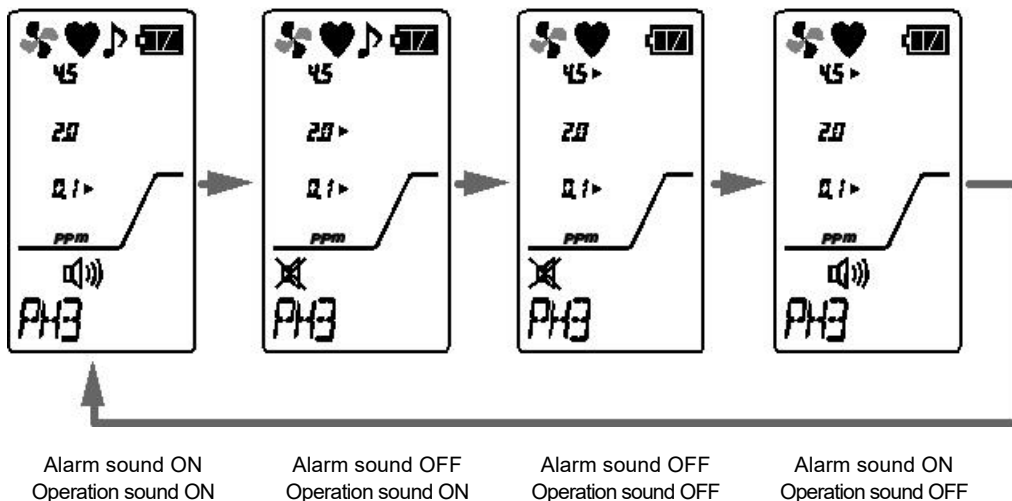

4-12. How to turn on the illumination lamp

The illumination lamp can be turned on when a measuring place is dark or in other situation.

- 1 Hold down the **AIR** and **POWER** buttons at the same time (for three seconds or longer).

The illumination lamp lights up. The illumination lamp will automatically go off in about two minutes after it lights up.

To turn off the illumination lamp, hold down the **AIR** and **POWER** buttons at the same time (for three seconds or longer).

4-13. Power-off

Press and hold the **POWER** button (at least three seconds) until the buzzer blips three times ("TURN OFF" disappears) to turn off the power.



CAUTION

- If a gas remains in the detector, it enters the automatic exhaust mode (for a maximum of 30 seconds). However, the detector is turned off after the automatic exhaust mode. The mode counts down from automatic exhaust start (PURGE 30). The detector switches to the "TURN OFF" display when the gas exhaust is completed and is turned off.

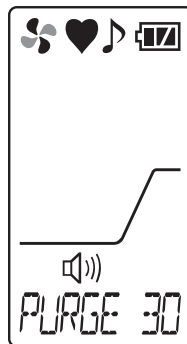

Automatic exhaust start (PURGE 30)

5

How to Set Display Mode

5-1. Entering the display mode

This mode allows users to view and change various display settings.
(Display example: For fumigation gases)

- 1 In the detection mode, press the **MODE** button.**

The detector enters the peak value display in the display mode.

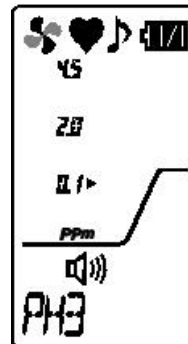

- 2 Next, press the **MODE** button to display the appropriate menu.**

The setting screen for the display mode is switched every time the button is pressed.

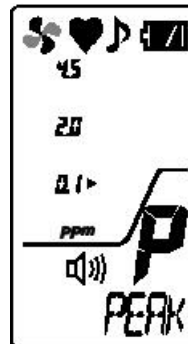

- 3 Select the setting item and press the **POWER** button.**

For setting items, see "Display mode overview" on page 27.

NOTE

- The detector automatically returns to the detection mode in about 20 seconds if the detector is left unoperated.
- Gas detection is continued in the display mode and an alarm can be activated.

Display mode overview

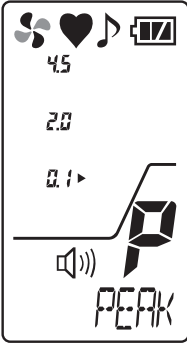
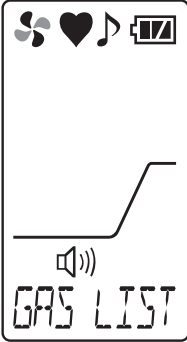
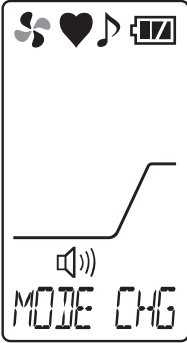
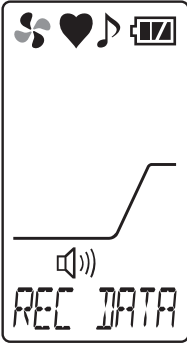
Item	LCD display	Details
Peak display	 <p>(Display example: For fumigation gases)</p>	<p>Displays the maximum concentration detected during the period from power-on to the point of checking.</p> <p>* To clear the peak display, hold down the MODE button (for one second).</p>
Concentration displayed gas reading setting		<p>By changing the setting to the pre-registered gas in the detector, the converted concentration from the detection target gas (PH3) will be displayed.</p> <p>(P. 29)</p>
Measuring mode setting (only for fumigation gases)		<p>Changes (in small measure) the pump suction volume by mode exchanging (in the differential measuring mode the pump suction volume is up).</p> <p>(P. 33)</p> <p>* NORMAL (Concentration measuring mode) DIFF (Differential measuring mode)</p>
Log data display		<p>Displays the data recorded by the snap logger. (P. 34)</p> <p>* Displayed only when the clock function is enabled See "6-3. Clock function ON/OFF setting" on page 38.</p>

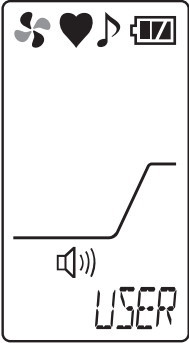
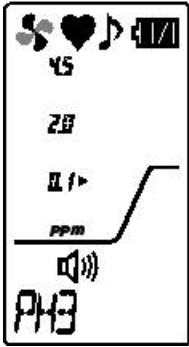
<p>Entering user mode</p>		<p>Enters the user mode. (P. 35)</p>
<p>Detection mode</p>		<p>Returns to the detection mode.</p>

5-2. Concentration displayed gas reading setting

Normally, the concentration display of the detector is "phosphine (PH₃)" depending on the specification; however, a pre-registered gas can be read instead to detect its concentration.
(Display example: For fumigation gases)

- 1 On the "GAS LIST" screen in the display mode, press the **POWER** button.

The detector enters the gas reading setting.

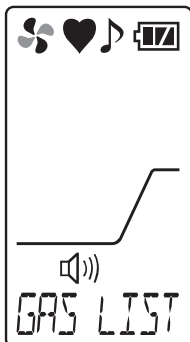

The currently set gas name is displayed.

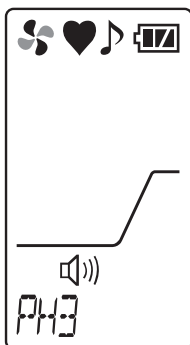

- 2 Press the **MODE** or **AIR** button to select a gas name to be read instead. The gas name switches to another every time the button is pressed.

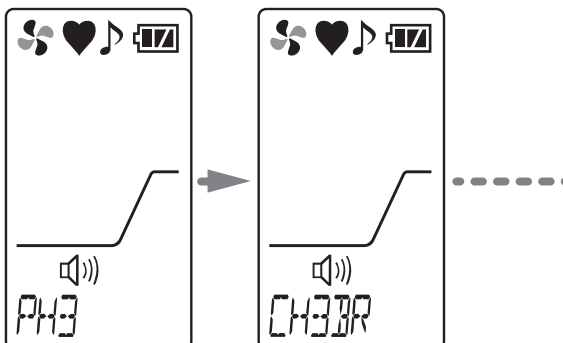

- 3 When the target gas name is displayed, press the **POWER** button. "END" is displayed, returning to the display mode.

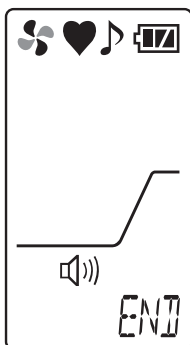

NOTE

- To perform the concentration displayed gas reading setting, see the "Gas list" in the following page.

Gas list for fumigation gases

Gas name (standard name)	Display	Scale 1	Scale 2	Scale 3	Remarks
Phosphine	PH3	0.1	2.0	4.5	
Methyl bromide	CH3Br	1	20	100	
Carbon disulfide	CS2	0.1	-	-	Sulfur compound. See the below NOTE.
Methyl iodide	CH3I	1	10	30	
Hydrogen cyanide	HCN	1	—	—	
Sulfuryl fluoride	SO2F2	—	—	800	
Ethylene bromide	C2H4Br2	1	10	30	

* - (bar display) has no scale.

NOTE

- High-concentration or continuous contact with a chloride or sulfur compound will shorten the sensor life or cause larger errors.
- If a Si compound is detected, the sensitivity will decrease, shortening the sensor life.
- Even for a gas shown only with the bar meter display but no scales, the meter reads Scale 2 or 3. Use it as an indication of concentration increase.
- If a high-concentration solvent gas is drawn, the rubber seal or other part used in the detector will deteriorate.

Gas list for semiconductor material gases

Gas name (standard name)	Display	Scale 1	Scale 2	Remarks
Phosphine	PH3	0.1	2.0	
Acetone	C3H6O	1	10	
Arsine	AsH3	0.2	-	
Ammonia	NH3	10	-	
Isobutane	i-C4H10	1	10	
Isopropyl alcohol	IPA	1	10	
Carbon monoxide	CO	10	30	
Ethyl alcohol	C2H5OH	1	10	
Ethylene	C2H4	1	10	
Vinyl chloride	VCM	1	-	Chloride See the below NOTE.

Gas name (standard name)	Display	Scale 1	Scale 2	Remarks
Methyl chloride	CH3CL	1	10	Chloride See the below NOTE.
Xylene	C8H10	1	10	
Ethylene oxide	EO	1	10	
Silane	SiH4	0.5	-	Si compound See the below NOTE.
Methyl bromide	CH3Br	1	20	
Hydrogen	H2	1	10	
Trichloroethylene	C2HCL3	10	-	Chloride See the below NOTE.
Toluene	C7H8	1	10	
1,2-Dichloroethane	EDC	1	10	Chloride See the below NOTE.
Sulfur dioxide	SO2	1	-	Sulfur compound. See the below NOTE.
Propane	C3H8	5	20	
R-134a	R-134a	50	250	
R-22	R-22	10	50	Chloride See the below NOTE.
R-32	R-32	10	50	
Normal hexane	n-C6H14	10	50	
Benzene	C6H6	0.5	10	
Formaldehyde (HCHO)	HCHO	10	50	
Methane	CH4	1	20	
Methyl alcohol	CH3OH	1	10	
Methyl ethyl ketone	MEK	1	10	
Hydrogen sulfide	H2S	0.1	-	Sulfur compound. See the below NOTE.
Diborane	B2H6	0.1	-	
Germane	GeH4	0.2	-	
Hydrogen bromide	HBr	10	-	
Hydrogen chloride	HCL	10	-	Chloride See the below NOTE.
R-407C	R-407C	10	50	
Hydrogen selenide	H2Se	0.5	-	
R-410A	R-410A	10	50	
R-404A	R-404A	10	50	
HFO-1234yf	CH2C2F4	10	30	

* - (bar display) has no scale.

NOTE

- High-concentration or continuous contact with a chloride or sulfur compound will shorten the sensor life or cause larger errors.
 - If a Si compound is detected, the sensitivity will decrease.
 - Even for a gas shown only with the bar meter display but no scales, the meter reads Scale 2. Use it as an indication of concentration increase.
 - If a high-concentration solvent gas is drawn, the rubber seal used in the detector will deteriorate.
-

5-3. Change of the measuring mode (only for fumigation gases)

The measuring mode of the detector (for fumigation gases) can be switched from "concentration measuring mode" to "differential measuring mode", where lower concentration detection can be conducted.

- 1** On the "MODE CHG" screen in the display mode, press the **POWER** button.

The detector enters the setting to switch the measuring mode.

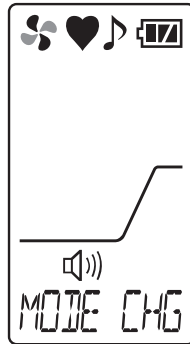

- 2** Press the **MODE** or **AIR** button to select the measuring mode.

The measuring mode switches to the other every time the button is pressed.

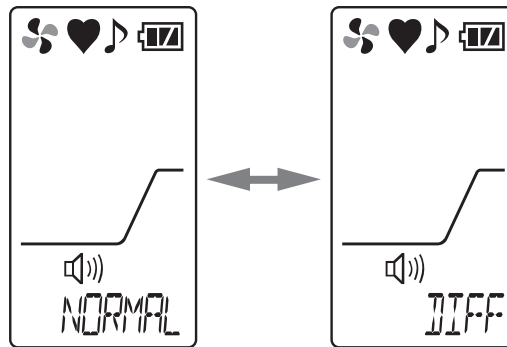

<Concentration measuring mode>

<Differential measuring mode>

- 3** In the appropriate measuring mode, press the **POWER** button.

"END" is displayed, returning to the display mode.

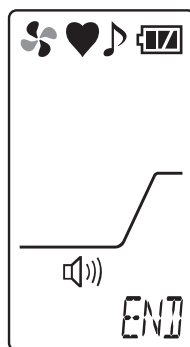

5-4. Log data display

The data recorded by the snap logger can be viewed.

The "REC DATA" screen is displayed only when the clock function is enabled (See "6-3. Clock function ON/OFF setting" on page 38).

(Display example: For fumigation gases)

- 1 On the "REC DATA" screen in the display mode, press the **POWER** button.

The detector enters the log data display.

The recorded date/time is displayed and the station ID and memory number are displayed alternately. If there is no recorded data, "NO DATA" is displayed.

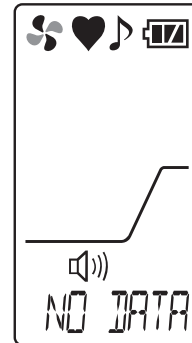
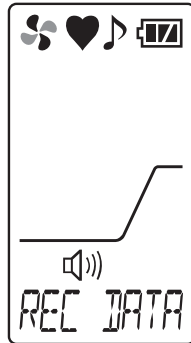

* When there is no recorded data

- 2 Press the **MODE** or **AIR** button to select log data to be displayed.

The recorded content switches to the other every time the button is pressed.

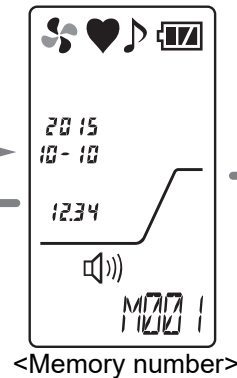
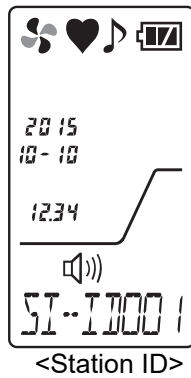

- 3 When the target log data is displayed, press the **POWER** button.

The gas name and peak value of the selected memory are displayed alternately.

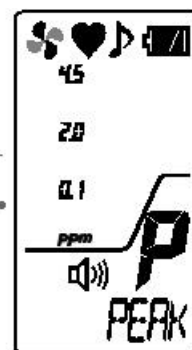
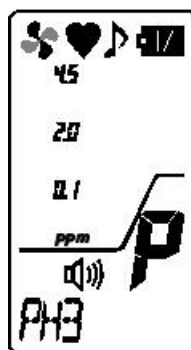

- 4 To exit the display, press the **MODE** and **AIR** buttons at the same time.

The detector returns to the display mode.

6

How to Set User Mode

6-1. Entering the user mode

The maintenance including internal clock correction, etc. can be performed.
(Display example: For fumigation gases)

- 1 In the detection mode, press the **MODE** button a few times to display entering user mode, press the **POWER** button**
The detector enters the date/time setting in the user mode.

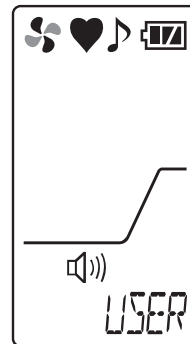

- 2 Next, press the **MODE** button to display the appropriate menu.**
The setting screen for the user mode switches to another every time the button is pressed.

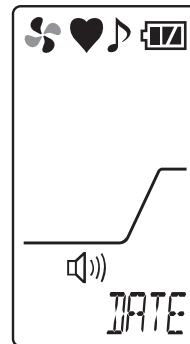

- 3 Select the setting item and press the **POWER** button.**
For setting items, see "User mode overview" on page 36.



CAUTION

- Return to the detection mode after use.

User mode overview

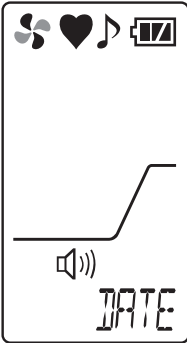
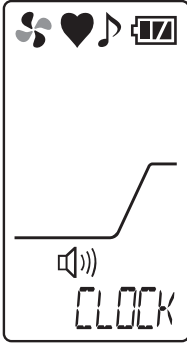
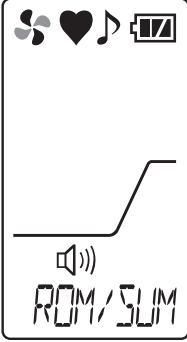
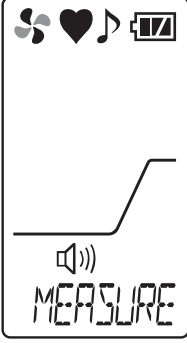
Item	LCD display	Details
Date/time setting		<p>Set the date/time of the internal clock. (P. 37)</p> <p>* When the clock function is disabled, the date/time setting screen is not displayed.</p>
Clock function ON/OFF setting		<p>Enable or disable the clock function.</p>
ROM/SUM display		<p>Displays the program number and SUM value of the detector.</p> <p>* This is not typically used by the user.</p>
Entering detection mode		<p>To exit the user mode, press the POWER button to enter the detection mode.</p>

6-2. Date/time setting

Set the date/time of the internal clock.

The date/time setting screen is displayed only when the clock function is enabled. Enable the clock function in "6-3. Clock function ON/OFF setting" on page 38 before setting the date/time.

- 1 On the "DATE" screen in the user mode, press the **POWER** button.
The detector enters the date/time setting.

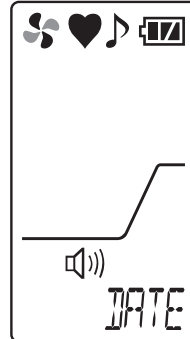

- 2 Press the **MODE** or **AIR** button, set the date/time and press the **POWER** button.

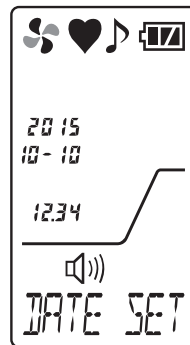

- 3 Set year -> month -> day -> hour -> minute in this order.

When the "minute" value is confirmed, "END" is displayed and then the detector returns to the user mode menu.

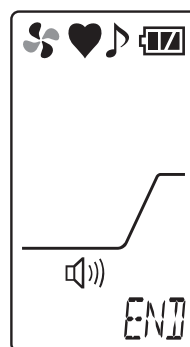

6-3. Clock function ON/OFF setting

Enable or disable the clock function.

The clock function is disabled by default. If the date/time needs to be displayed on start-up or the snap logger function is used, enable the clock function.

- 1 On the "CLOCK" screen in the user mode, press the **POWER** button.

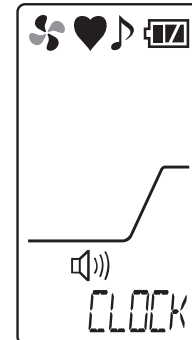

- 2 Press the **MODE** or **AIR** button, select ON/OFF of the clock function and press the **POWER** button.

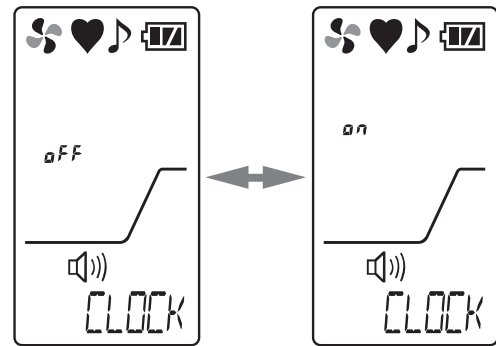

- 3 **Setting completed**

After the clock function ON/OFF setting is completed, "END" is displayed and then the detector returns to the user mode menu.

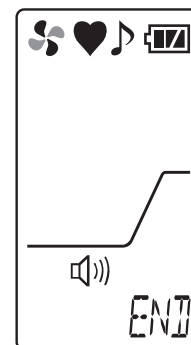

NOTE

- When the clock function is changed from disabled to enabled, a clock abnormality (FAIL CLOCK) may be triggered if the date/time is inaccurate. When the failure condition is reset using the MODE button, the detector moves to the date/time setting screen. Set the date/time in accordance with "6-2. Date/time setting" on page 33.
- When the clock function is changed from disabled to enabled for the first time, powered on after leaving the detector for more than five minutes with the batteries removed, or powered on with the batteries inserted with incorrect polarities, a clock abnormality (FAIL CLOCK) may be triggered.

7

Alarm function

7-1. Gas alarm activation

"Gas alarm" is triggered in the detector using a blinking alarm lamp, buzzer sound and bar meter display when the concentration of detected gas reaches or exceeds the alarm setpoint values. (Auto-reset operation)

Blinking alarm lamp and buzzer sound operation for gas alarms have different intervals depending on the detected concentration.

7-2. Fault alarm activation

"Fault alarm" is triggered using a buzzer sound and blinking alarm lamp when an abnormality is detected in the detector. (Self-latching)

When an alarm is triggered, one of the following fault details is displayed on the LCD.

- System abnormalities: FAIL SYSTEM
- Calibration abnormalities: FAIL AIR CAL
- Low flow rate: FAIL LOW FLOW
- Pump abnormalities: FAIL PUMP
- Sensor abnormalities: FAIL SENSOR
- Low battery voltage: FAIL BATTERY
- Clock abnormalities: FAIL CLOCK

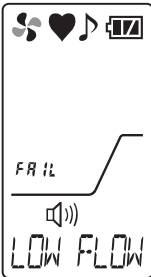
Alarm lamp	Repeatedly blinks at about one-second intervals.
Buzzer	Repeatedly sounds intermittent blips at about one-second intervals. Blip-blip, blip-blip
LCD display	Display example of low flow rate (LOW FLOW) 

If a fault alarm is triggered, determine the cause and take appropriate action.

If the detector has problems and is repeatedly malfunctioning, contact RIKEN KEIKI immediately.

NOTE

- The low flow rate alarm (FAIL LOW FLOW) can be reset by pressing the **MODE** button.
- For information on malfunctions (error messages), see "Troubleshooting" on page 46.

8

Maintenance

The detector is a precision devices.

To maintain the performance of the detector and improve the reliability of detecting leakage, perform a regular maintenance.

8-1. Maintenance intervals and items

Perform the following maintenance regularly before use.

- Daily maintenance: Perform maintenance before commencing each work.
- Monthly maintenance: Perform alarm test once a month.
- Regular maintenance: Perform maintenance once or more for one year to maintain the performance as a unit.

Maintenance item	Maintenance content	Daily maintenance	Monthly maintenance	Regular maintenance
Battery level check	Check that the battery level is sufficient.	○	○	○
Concentration display check	Make the detector draw in fresh air and check that the concentration display value is zero. When the reading is incorrect, perform zero adjustment by air calibration after ensuring that no other gases exist around it.	○	○	○
Flow rate check	Check the pump driving indicator to find abnormalities.	○	○	○
Filter check	Check the dust filter for dust or clogging.	○	○	○
Gas alarm calibration	Perform the gas alarm using a calibration gas.	—	—	○

About maintenance services

We provide services on regular maintenance including span adjustment, other adjustments and maintenance.

To make the calibration gas, dedicated tools, such as a gas cylinder of the specified concentration, gas sampling bag, etc., must be used.

Our qualified service engineers have expertise and knowledge on the dedicated tools used for services, along with other products. To maintain the safety operation of the gas detector, please use our maintenance service.

The followings are typical maintenance services. For details, contact RIKEN KEIKI.

<Main Services>

Item	Services
Battery level check	Checks the battery level.
Concentration display check	Verifies that the concentration display value is zero by using the zero gas. Performs the air calibration if the reading is incorrect.
Flow rate check	Checks the flow rate indicator to find abnormalities. Checks the flow rate by using an external flow meter to verify the correctness of the flow rate indicator on the detector. If the flow rate is incorrect, performs the flow rate adjustment.
Filter check	Checks the dust filter for dust or clogging. Replaces a dirty or clogged dust filter.
Span adjustment	Performs span adjustment using a calibration gas.
Cleaning and repair of the unit (visual diagnosis)	Checks dust or damage on the surface of the unit, cleans and repairs such parts. Replaces parts which are cracked or damaged.
Unit operation check	Operates the buttons to check the operation of functions and parameters, etc.
Replacement of consumable parts	Replaces consumable parts, such as a sensor, filter, pump, etc.

8-2. How to clean

Clean the detector if it becomes extremely dirty. The detector must be turned off while cleaning it. Use a waste cloth or the like to remove dust. Do not use water or organic solvent for cleaning because they may cause malfunctions.

Because an extremely contaminated inside of the taper nozzle may disturb the gas detection, it must be cleaned with dry air, etc.



CAUTION

- When cleaning the detector, do not splash water over it or use organic solvents such as alcohol, benzene, etc. on it. Otherwise, it may cause discoloration or damage to the surface of the detector or a sensor failure.

NOTE

- When the gas detector gets wet, water may remain in the buzzer sound opening or grooves. Drain water as follows:
 - (1) Wipe away moisture on the gas detector thoroughly using a dry towel, cloth, etc.
 - (2) While holding the gas detector firmly, shake it about ten times with the buzzer sound opening facing downward.
 - (3) Wipe away moisture coming out from the inside thoroughly using a towel, cloth, etc.
 - (4) Place the gas detector on a dry towel, cloth, etc. and let it stand at normal temperatures.

8-3. Parts replacement

Filter replacement procedure

Continuing to use the detector may cause the filter to be contaminated or clogged.

Replace the filter if it becomes extremely dirty.

Also, replace the filter when it has absorbed water or has a lower flow rate.

- 1 Turn the cap counterclockwise and remove it.**



- 2 Remove the rubber seal from the cap.**



- 3** Replace the filter placed inside the rubber seal with a new one.



- 4** Attach the rubber seal with the filter attached, to the cap.
At this time, check that the rib has been firmly inserted into the groove.

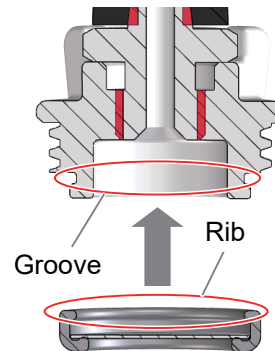

- 5** Attach the cap with the rubber seal attached, to the main unit.

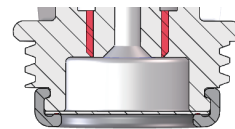

Sensor replacement

The built-in sensors of the detector have a validity period and must be replaced regularly (warranty period one year).

The sensor life has expired if, for example, the sensors cannot be calibrated in span adjustment, the readings do not come back after air calibration, or the readings fluctuate.

In this case, contact RIKEN KEIKI.

Battery replacement

For battery replacement, see "How to replace the batteries" on page 12.

9

Storage and Disposal

9-1. Procedures to store the detector or leave it for a long time

The detector must be stored under the following environmental conditions.

- In a dark place under the normal temperature and humidity away from direct sunlight
- In a place where gases, solvents or vapors, etc. are not present

Store the detector in a shipping carton, if any, in which the product was delivered.
Store the gas detector away from dust, etc. if the shipping carton is not available.



CAUTION

- If the detector is not used for a long time, store it after removing the batteries. Leaks from dry batteries may result in fire or injury.
- If the gas detector is not used for a long time, turn on the power at least once every six months and check that the pump draws in air (about three minutes). The gas detector, when not activated for a long time, may cease to work because of hardening of the grease in the pump motor.

9-2. Procedures to use the detector again



CAUTION

- When the detector is used again after a long-period storage, never fail to perform a calibration.
- Contact RIKEN KEIKI for information on readjustment including calibration.

9-3. Disposal of products

When the detector is disposed of, it must be treated properly as an industrial waste in accordance with the local regulations, etc.



WARNING

- Dispose of dry batteries in accordance with procedure specified by the local authority.

<Disposal in EU Member States>

When disposing of the detector in EU member states, sort the batteries as specified. Handle the removed batteries according to the classified refuse collection system and recycling system based on the regulations of EU member states.

Removing batteries

For battery removal, see "4-3. How to replace the batteries" on page 12.

NOTE**Crossed-out recycle dustbin mark**

This symbol mark is indicated on the products which contain the batteries which fall under EU Battery Directive 2006/66/EC. Such batteries need to be disposed of as specified by the latest Directive. This symbol mark indicates that the batteries need to be separated from the ordinary waste and disposed of appropriately.



10

Troubleshooting

The Troubleshooting does not explain the causes of all the malfunctions which occur on the detector. This simply helps to find the causes of malfunctions which may frequently occur.

If the gas detector shows a symptom which is not explained in this manual, or still has malfunctions even though remedial actions are taken, please contact RIKEN KEIKI.

<Abnormalities on Unit>

Symptoms	Causes	Actions
The power cannot be turned on.	The battery level is too low.	Replace both of the two batteries with new ones.
	The POWER button was released quickly.	For power-on, keep the POWER button pressed until a blip is heard.
	Dry batteries are not installed properly.	Check that the batteries are properly installed to the main unit.
Abnormal operations	Disturbances by sudden static electricity noise, etc.	Turn off the power once and then turn it on again (restart).
Cannot operate the gas detector.	Disturbances by sudden static electricity noise, etc.	Remove the batteries in a safe place. Then reinstall them and turn on the power to perform operations.
System abnormalities FAIL SYSTEM	A circuit abnormality occurred.	Request Riken Keiki for repair.
Sensor abnormalities FAIL SENSOR	A sensor has failed.	Remove the batteries in fresh air. Then reinstall them and turn on the power to perform operations. Restart the detector a few times. If the problem still persists, request RIKEN KEIKI to replace the sensor.
A low battery voltage alarm is displayed. FAIL BATTERY	The battery level is low.	Turn off the power and replace the dry batteries with new ones in a safe area.

Symptoms	Causes	Actions
A low flow rate alarm is displayed. FAIL LOW FLOW	Water, oil or the like is drawn.	Check the taper nozzle for any damage or mark of drawn water, oil, etc.
	The taper nozzle is clogged.	Check the taper nozzle for connection condition, clogging, torsion, etc.
	The detector was powered on at a low temperature or has not been used for a long time.	Cycle the power a few times. The pump may start operating. If the problem still persists, request RIKEN KEIKI to replace the pump.
	The pump has deteriorated.	Request the dealer or Riken Keiki local representative to replace the pump.
Air calibration impossible FAIL AIR CAL	Fresh air is not supplied around the detector.	Supply fresh air and then perform air calibration in the measured atmosphere.
Clock abnormalities FAIL CLOCK	Abnormalities of the internal clock	Make a setting of date/time. If such a symptom is observed repeatedly, the built-in clock is seemingly malfunctioning. Thus, it must be replaced. Request RIKEN KEIKI for repair.
PUMP abnormalities FAIL PUMP	PUMP abnormalities	Cycle the power a few times. The pump may start operating. If the problem still persists, request RIKEN KEIKI to replace the pump.

11

Product Specifications

Model	SP-220 (TYPE FUM) (Fumigation gases)	SP-220 (TYPE SC) (Semiconductor material gases)
Gas to be detected	Single channel (Refer to "Gas list for fumigation gases" on page 30 and "Gas list for semiconductor material gases" on page 30 for target gases such as PH3.)	
Detection principle	Hot-wire semiconductor	
Measurement range	Depends on the measured gas (PH3: 0.0-4.5ppm)	Depends on the measured gas (PH3: 0.0-2.0ppm)
Alarm type	Gas Alarm: Triggered when the concentration of detected gas reaches or exceeds the alarm setpoint value.	
	Fault alarm: Sensor connection/disconnection, low battery, low flow rate, circuit abnormality, calibration range abnormality, clock abnormality and pump abnormality	
Alarm operation	Gas Alarm: Lamp blinking and intermittent buzzer sounding Fault alarm: Lamp blinking, intermittent buzzer sounding and fault detail display	
Alarm setpoint	Depends on the measured gas (PH3: Set arbitrarily to 0.1, 2.0 or 4.5 ppm)	Depends on the measured gas (PH3: Set arbitrarily to 0.1 or 2.0 ppm)
Detection method	Pump suction type	
Response time	Within ten seconds of 0.1 ppm alarm by contact with PH3: 0.3 ppm	
LCD display	Display contents: Gas name, gas concentration (scale + bar display), time, battery level, drawing, operation and mode	
Power supply	AA alkaline battery: 2	
Continuous operating time	12 hours or more (normal temperature, without alarms or lighting)	
Operating environment	Operating temperature range: -20 - +55°C Operating humidity range: 95%RH or less (Non-condensing)	
External dimensions	External dimensions: 43 (W) x 200 (H) x 39 (D) mm (projection portions excluded)	
Weight	Weight: Approx. 215 g (without batteries)	
Drip-proof and dust-proof performances	Equivalent to IP-55	
Functions	LCD backlight (automatically lights up in response to an alarm), Data logger, Log data display, Peak hold, Clock display, Changing a reading target gas	
Accessories	2 AA alkaline dry batteries, Hand strap, Rubber protection cover, Waterproofing filter for exchange(5 pcs), Taper nozzle	

* The gas concentration is only approximate because the detector is designed to be used to detect a small amount of gas leakage.

12

Appendix

12-1. Definition of terms

vol%	Gas concentration indicated in the unit of one-hundredth of the volume
ppm	Gas concentration indicated in the unit of one-millionth of the volume
LEL	The acronym of Lower Explosive Limit. LEL refers to the lowest concentration of a combustible gas in air capable of causing explosion when ignited.



EU-Declaration of Conformity

Document No. 320CE24056



We, RIKEN KEIKI Co., Ltd. 2-7-6, Azusawa, Itabashi-ku, Tokyo, 174-8744, Japan declare under our sole responsibility that the following product conforms to all the relevant provisions.

Product Name Portable Gas Leak Detector
Model SP-220(TYPE SC), SP-220(TYPE FUM)

Council Directives	Applicable Standards
EMC Directive (2014/30/EU)	EN 50270:2015
BATTERY Regulation ((EU)2023/1542)	-
RoHS Directive (2011/65/EU[1])	EN IEC 63000:2018

^[1]Including substances added by Commission Delegated Directive (EU) 2015/863

Place: Tokyo, Japan

Date: May. 24, 2024

Takakura Toshiyuki
General manager
Quality Control Center



UK-Declaration of Conformity

Document No.: 320UK22070



We, RIKEN KEIKI Co., Ltd. 2-7-6, Azusawa, Itabashi-ku, Tokyo, 174-8744 Japan declare under our sole responsibility that the following product conforms to all the relevant provisions.

Product Name: Portable Gas Leak Detector
Model: SP-220(TYPE SC), SP-220(TYPE FUM)

Regulations	UK designated Standards
Electromagnetic Compatibility Regulations 2016 (S.I. 2016/1091)	BS EN 50270:2015
The Restriction of the Use of Certain Hazardous Substances in Electrical and Electronic Equipment Regulations 2012 (S.I. 2012/3032)	BS EN IEC 63000:2018

Place: Tokyo, Japan

Date: May. 27, 2022

Takakura Toshiyuki
General manager
Quality Control Center