



Portable
Combustible Gas Detector
GP-1000
Operating Manual
(PT0-120)

RIKEN KEIKI Co., Ltd.

2-7-6 Azusawa, Itabashi-ku, Tokyo, 174-8744, Japan

Phone : +81-3-3966-1113

Fax : +81-3-3558-9110

E-mail : intdept@rikenkeiki.co.jp

Web site : <https://www.rikenkeiki.co.jp/>

Safety information

The Combustible Gas Monitor Model GP-1000 is a gas monitor designed to provide continuous monitoring of exposure to combustible gas in hazardous areas.

The measuring range of GP-1000 is 0-100%LEL

The gas sample is sucked in by built-in micro pump.

Power supply is only with four series connected Alkaline Manganese AA batteries , type LR6 manufactured by TOSHIBA.

Battery exchange in a hazardous area is not performed.

Specification for safety

- Ex ia IIB T4 Ga



II 1G Ex ia IIB T4 Ga

- Ambient temperature range : -20°C to +50°C

Electrical data

- Powered by four series AA size alkaline batteries, type LR6 by TOSHIBA.

Certificate numbers

- IECEx Certificate number : IECEx DEK 13.0090
- ATEX Certificate number : DEKRA 13 ATEX 0227
- UKEX Certificate number : DEKRA 21UKEX0363

List of standards

- | | | |
|---------------------|-----------------------|--------------------------|
| • IEC 60079-0:2017 | • EN IEC 60079-0:2018 | • BS EN IEC 60079-0:2018 |
| • IEC 60079-11:2011 | • EN 60079-11:2012 | • BS EN 60079-11:2012 |

WARNING

- Do not replace dry batteries in hazardous location.
- Do not attempt to disassemble or alter the instrument.
- Use only alkaline AA batteries, type LR6 manufactured by TOSHIBA.
- Use only backup battery type CR1220 manufactured by Maxell.

INST. No. 0 0 0 0 0 0 0 0 0 0
 A B C D E

A: Manufacturing year (0-9)

B: Manufacturing month (1-9,XYZ for Oct.-Dec.)

C: Manufacturing lot

D: Serial number

E: Code of factory



RIKEN KEIKI Co., Ltd.

2-7-6 Azusawa, Itabashi-ku, Tokyo, 174-8744, Japan

Phone : +81-3-3966-1113
Fax : +81-3-3558-9110 GIII
E-mail : intdept@rikenkeiki.co.jp
Web site : <https://www.rikenkeiki.co.jp>

<Contents>

1. Outline of the Product.....	3
1-1. Preface.....	3
1-2. Purpose of use.....	3
1-3. Definition of DANGER, WARNING, CAUTION, and NOTE.....	3
1-4. Method of confirmation for Standards and Explosion proof specification.....	4
2. Important Notices on Safety.....	5
2-1. Danger cases.....	5
2-2. Warning cases.....	6
2-3. Precautions.....	7
3. Product Components.....	9
3-1. Main unit and standard accessories.....	9
3-2. Names and functions for each part.....	10
4. How to Use.....	13
4-1. Before using the gas detector.....	13
4-2. Preparation for start-up.....	13
4-3. How to start the gas detector.....	16
4-4. How to detect.....	20
4-5. Modes.....	23
4-6. Display mode.....	27
4-6-1. Entering display mode.....	27
4-6-2. Concentration displayed gas reading setting.....	28
4-6-3. Alarm setpoint display.....	30
4-6-4. Pump suction volume setting.....	31
4-6-5. Log data display.....	32
4-7. User mode.....	33
4-7-1. Entering user mode.....	33
4-7-2. Peak bar display setting.....	35
4-7-3. Date/time setting.....	36
4-8. Calibration mode.....	37
4-8-1. Entering calibration mode.....	37
4-8-2. Bump test.....	39
4-8-3. Air calibration.....	40
4-8-4. AUTO CAL.....	41
4-8-5. ONE CAL.....	43
4-8-6. Bump test condition setting.....	44
4-8-7. Password setting.....	45
4-9. Power-off.....	46
5. Operations and Functions.....	47
5-1. Gas alarm activation.....	47
5-2. Fault alarm activation.....	49
6. Maintenance.....	50
6-1. Maintenance intervals and items.....	50
6-2. How to clean.....	51
6-3. Replacement of consumables.....	52
6-4. Air calibration.....	53
6-5. Span calibration.....	53
7. Storage and Disposal.....	54
7-1. Procedures to store the gas detector or leave it for a long time.....	54
7-2. Procedures to use the gas detector again.....	54
7-3. Disposal of products.....	54
8. Troubleshooting.....	56
9. Product Specifications.....	58

1

Outline of the Product

1-1. Preface



Thank you for choosing our portable combustible gas detector GP-1000 (hereinafter referred to as the gas detector). Please check that the model number of the product you purchased is included in the specifications on this manual.

This manual explains how to use the gas detector and its specifications. It contains information required for using the gas detector properly. Not only the first-time users but also the users who have already used the product must read and understand the operating manual to enhance the knowledge and experience before using the gas detector.

1-2. Purpose of use

This product is used to detect combustible gases (% LEL) in the air. It provides two different specifications for target combustible gases: "general combustible gases (HC)" used in ordinary factories, oil tankers, etc. and "methane (CH₄)" such as city gas and natural gas. Detection results are not intended to guarantee life or safety in any way.

1-3. Definition of DANGER, WARNING, CAUTION, and NOTE

 DANGER	This message indicates that improper handling may cause serious damage on life, health or assets.
 WARNING	This message indicates that improper handling may cause serious damage on health or assets.
 CAUTION	This message indicates that improper handling may cause minor damage on health or assets.
NOTE	This message indicates advice on handling.

1-4. Method of confirmation for Standards and Explosion proof specification

This instrument has some specification depends on standard and explosion proof certificate. Please confirm the detector specification before using. Please refer Declaration of Conformity that is at the end of this manual if you have CE/UKCA marking type.

You can confirm instrument specification to see name plate as follows.

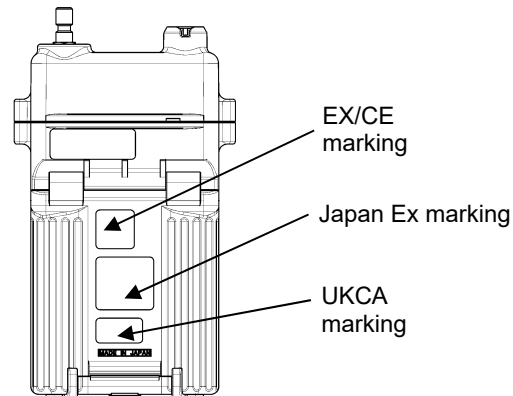

Name plate attachment position

2

Important Notices on Safety

2-1. Danger cases



DANGER

About explosion-proof

- Do not modify or change the circuit or structure, etc.
- When using the gas detector in a hazardous area, take the following countermeasures for preventing dangers resulting from electrostatic charges.
 - (1) Wear anti-static clothes and conductive shoes (anti-static work shoes).
 - (2) For indoor use, use the gas detector while standing on a conductive work floor (with a leakage resistance of 10 MΩ or less).
- The specifications of the gas detector are as follows:
 - 6.0 VDC (Toshiba LR6)
 - Ambient temperature: -20 to 50°C

About use

- While conducting measurement in a manhole or confined space, do not lean over or look into the manhole or closed space. It may lead to dangers because oxygen-deficient air or other gases may blow out.
- High-concentration (100% LEL or higher) gases may be discharged from the gas exhausting outlet. Never use fire near the gas detector.

2-2. Warning cases



WARNING

Sampling point pressure

- The gas detector is designed to draw gases around it under the atmospheric pressure. If excessive pressure is applied to the gas inlet and outlet (GAS IN, GAS OUT) of the gas detector, detected gases may leak out from its inside and may cause dangerous conditions. Be sure that excessive pressure is not applied to the gas detector while used.
- Do not connect the gas sampling hose directly to a location with a pressure higher than the atmospheric pressure. The internal piping system may be damaged.

Air calibration in atmosphere

When the air calibration is performed in the atmosphere, check the atmosphere for freshness before beginning the air calibration. If other gases exist, the adjustment cannot be performed properly, thus leading to dangers when the gas leaks.

Response to gas alarm

Issuance of a gas alarm indicates that there are extreme dangers. Take proper actions based on your judgment.

Battery level check

- Before use, check that there remains sufficient battery power. When the gas detector is not used for a long period, the batteries may be exhausted. Replace them with new ones before use.
- If a low battery voltage alarm is triggered, gas detection cannot be conducted. If the alarm is triggered during use, turn off the power and promptly replace the batteries in a non-hazardous area.

Others

- Do not throw the gas detector into fire.
- Do not wash the gas detector in a washing machine or ultrasonic cleaner.
- Do not block the . No alarm sound can be heard.
- Do not remove the battery while the power is on.

2-3. Precautions



CAUTION

Do not use the gas detector where it is exposed to oil, chemicals, etc. Do not submerge the gas detector under water on purpose.

- Do not use in a place where the gas detector is exposed to liquids such as oil and chemicals.
- The gas detector, being compliant to IP67, is not water-pressure-resistant. Do not use the gas detector where a high water pressure is applied to it (under a faucet, shower, etc.) or submerge it under water for a long time. The gas detector is water-proof only in fresh water and running water, and not in hot water, salt water, detergent, chemicals, human sweat, etc.
- The gas inlet and outlet are not water-proof. Be careful not to let water such as rainwater get into these parts. Because this may cause trouble and gas cannot be detected.
- Do not place the gas detector where water or dirt gets accumulated. The gas detector placed at such a location may cause malfunction due to water or dirt that gets into the buzzer opening, etc.
- Note that drawing in dirty water, dust, metallic powder, etc. will significantly deteriorate the sensor sensitivities. Be careful when the gas detector is used in an environment where these elements exist.

Do not use the gas detector in a place where the temperature drops below -20°C or rises over 50°C .

- The operating temperature of the gas detector is -20 to 50°C . Do not use the gas detector at higher temperatures, humidities, and pressures or at lower temperatures than the operating range.
- Avoid long-term use of the gas detector in a place where it is exposed to direct sunlight.
- Do not store the gas detector in a sun-heated car.

Observe the operating restrictions to prevent condensation inside the gas detector or gas sampling hose.

Condensation formed inside the gas detector or gas sampling hose causes clogging or gas adsorption, which may disturb accurate gas detection. Thus, condensation must be avoided. In addition to the operating environment, carefully monitor the temperature/humidity of the sampling point to prevent condensation inside the gas detector or gas sampling hose. Please observe the operating restrictions.

Do not use a transceiver near the gas detector.

- Radio wave from a transceiver near the gas detector may disturb readings. If a transceiver is used, it must be used in a place where it disturbs nothing.
- Do not use the gas detector near a device that emits strong electromagnetic waves (high-frequency or high-voltage devices).

Verify that the pump driving indicator is rotating before using the gas detector.

If the pump driving indicator is not rotating, gas detection cannot be performed properly. Check whether the flow rate is lost.

Never fail to perform a regular maintenance.

Since this is a safety unit, a regular maintenance must be performed to ensure safety. Continuing to use the detector without performing a maintenance will compromise the sensitivity of the sensor, thus resulting in inaccurate gas detection.

**CAUTION****Others**

- Pressing buttons unnecessarily may change the settings, preventing alarms from activating correctly. Operate the gas detector using only the procedures described in this operating manual.
- Do not drop or give shock to the gas detector. The accuracy of the gas detector may be deteriorated.
- Do not jab the buzzer opening with a sharp-pointed item. Doing so may cause a failure or damage.
- Do not remove the panel sheet on the display. The water-proof and dust-proof performances will be deteriorated.
- Do not affix a label on the infrared port. Infrared communications can no longer be conducted.
- The operating environment may include gases that have harmful effects on the sensor of the gas detector. The gas detector cannot be used in the presence of the following gases:
 - (1) Sulfides (such as H₂S and SO₂) continuously existing in high concentrations
 - (2) Halogen gases (such as chloride compounds and chlorofluorocarbons)
 - (3) Silicone (Si compounds)

Do not use the gas detector in the presence of the above gases (such as high-concentration sulfides, halogen gases and silicone), which may shorten the sensor life significantly or cause malfunctions such as inaccurate readings.

In case the gas detector is used for detection in the presence of silicone, etc., be sure to check the gas sensitivities before using it again.

3

Product Components



3-1. Main unit and standard accessories

After opening the package, check the main unit and accessories.
If anything in the following list is not included, contact RIKEN KEIKI.

<Main Unit>



<Standard Accessories>

Name	Appearance	Quantity	Name	Appearance	Quantity
AA Alkaline dry battery		4 pcs (installed)	Hand strap		1
Gas sampling probe and gas sampling hose		1	Operating manual	—	1
			Product warranty	—	1

3-2. Names and functions for each part

<Appearance> (main unit)

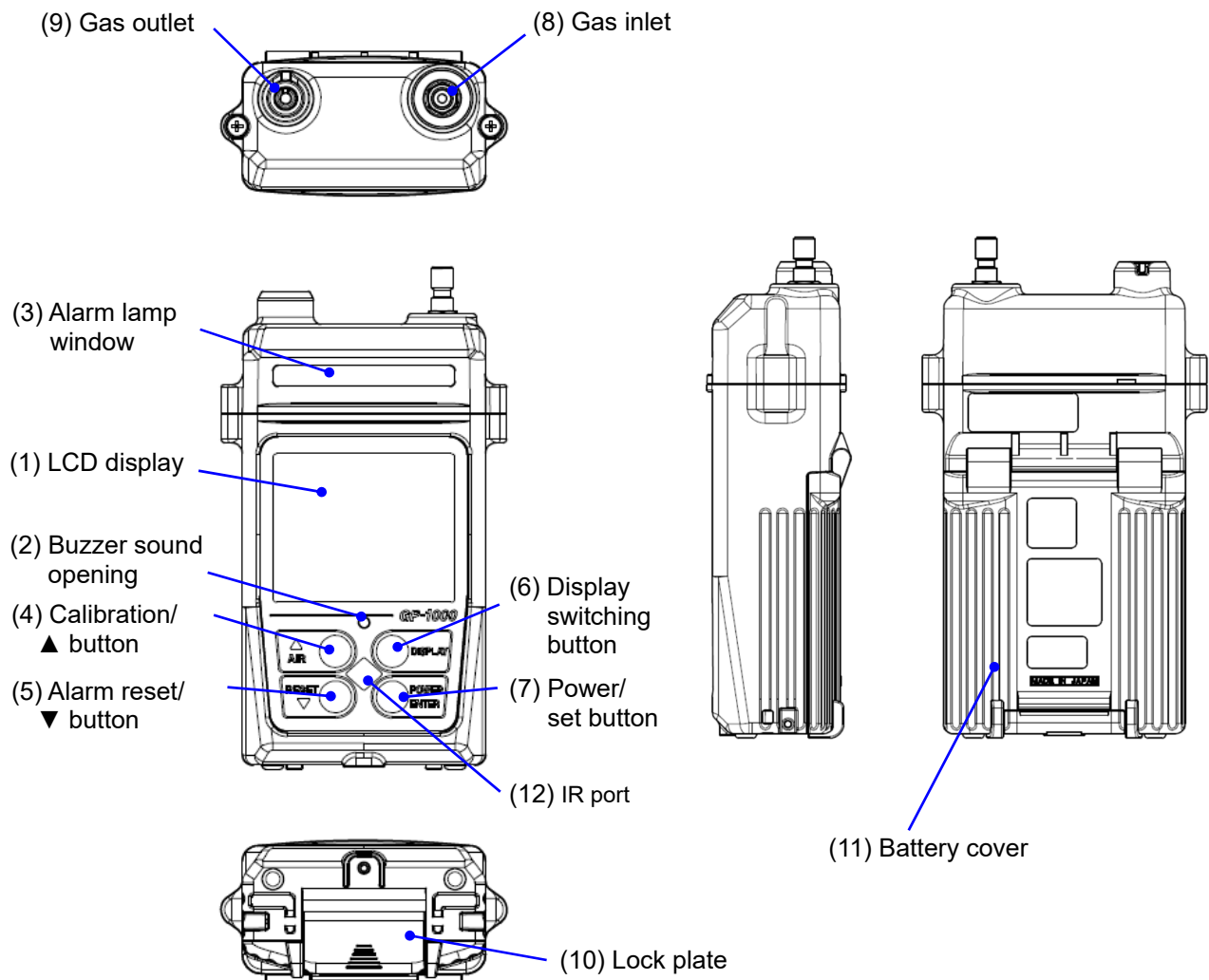

No.	Name	Function
(1)	LCD display	Displays gas concentrations, measured gas name, alarms, etc.
(2)	Buzzer sound opening	Emits operation and alarm sounds. (Do not block it.)
(3)	Alarm lamp window	Blinks (in red) in response to an alarm.
(4)	Calibration/▲ button	Keep this switch pressed to perform fresh air adjustment.
(5)	ALARM reset/▼ button	When an alarm occurs, press this switch to reset the alarm.
(6)	Display switching button	Press this switch to change between display modes.
(7)	Power/set button	Turns the power ON/OFF.
(8)	Gas inlet	Connect a gas sampling hose to this port.
(9)	Gas outlet	Exhausts the gas drawn into the gas detector. (Do not block it.)
(10)	Lock plate	Retains the battery cover.
(11)	Battery cover	Protects the battery.
(12)	IR port	Used to send and receive data. While the data logger management software (option) is used, this port is used to upload detection data to the PC and configure the settings of the gas monitor from the PC.

<LCD Display>

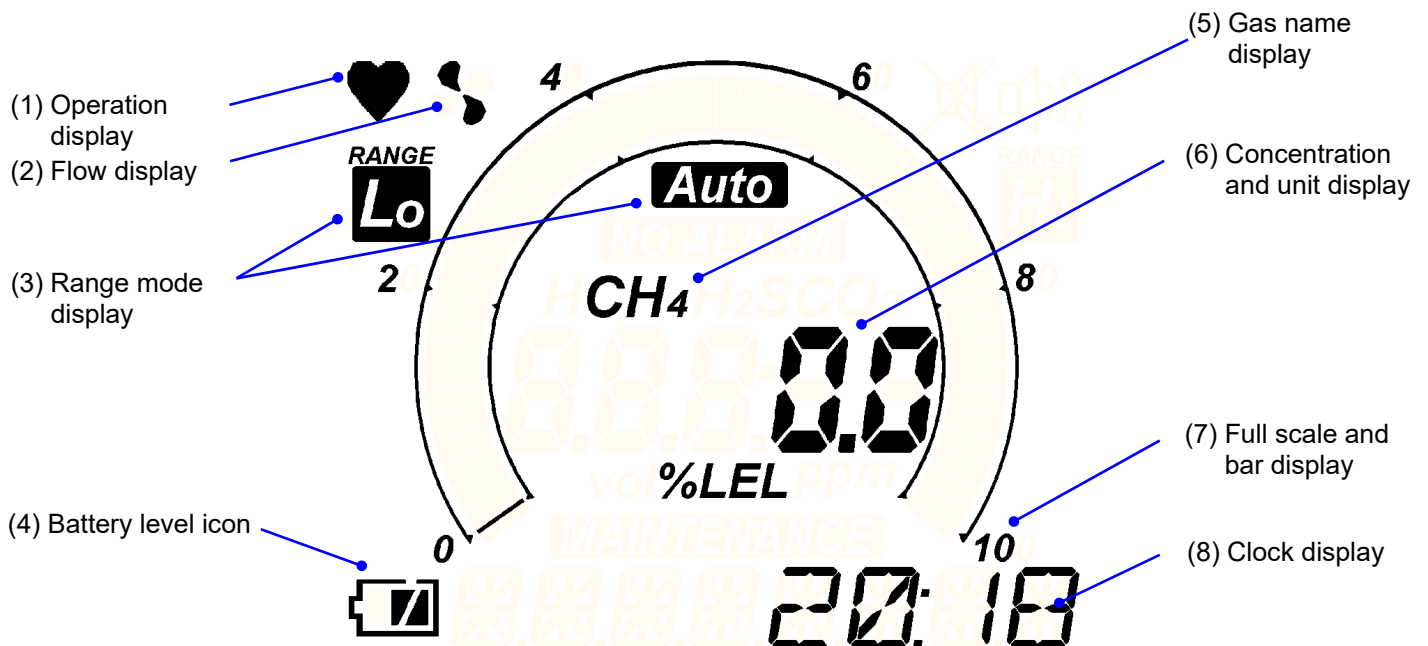

No.	Name	Function
(1)	Operating state display	Displays the operating status in the detection mode. Normal: Blinking
(2)	Flow check display	Displays the drawing status. Normal: Rotating
(3)	Range mode display	Displays Lo/Hi/Auto icon of range mode.
(4)	Battery level icon	Displays a reference of the battery level.
(5)	Gas name display	Displays detected gas name.
(6)	Concentration and unit display	Displays gas concentration and unit.
(7)	Full scale and bar display	Displays the level of gas concentration with the bar meter as well as the full scale value.
(8)	Clock display	Displays the current time.

NOTE

The meanings of battery level icons are as follows:

: Sufficient / : Low / : Needs replacement If the battery level is lower than the above, the inside of the battery icon starts to blink ().

NOTE

Range mode display icons

Lo : Fixed to the low range (0-10.0% LEL)

Hi : Fixed to the high range (0-100% LEL)

Auto : Automatic switch from the low range to high range

<Appearance> (Gas sampling probe and gas sampling hose)

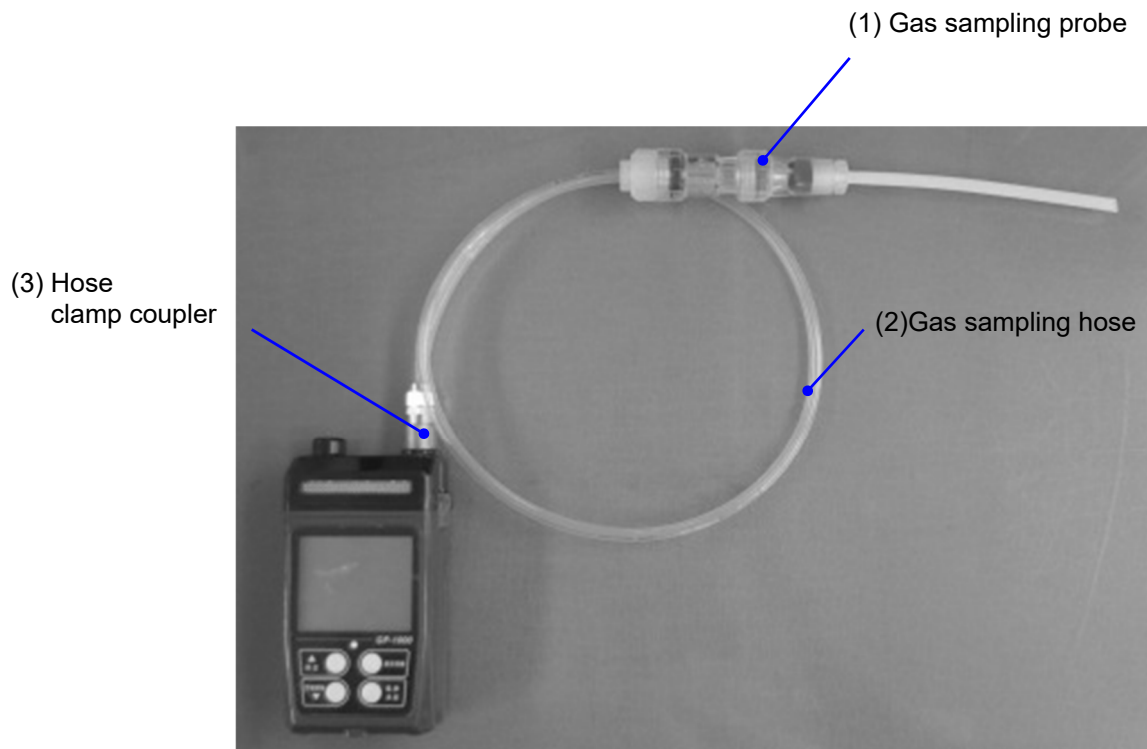

No.	Name	Function
(1)	Gas sampling probe	Placed in a detection area to collect a gas. The probe includes a dust filter.
(2)	Gas sampling hose	A resin hose through which the sampled gas passes.
(3)	Hose clamp coupler	A joint that connects with the main unit.

4

How to Use

4-1. Before using the gas detector

Not only the first-time users but also the users who have already used the gas detector must follow the operating precautions.

Ignoring the precautions may damage the gas detector, resulting in inaccurate gas detection.

4-2. Preparation for start-up



CAUTION

- The display is covered by the protective film to prevent scratches from shipping.
- Be sure to remove this film before use.
- Gas monitor with this film will not satisfy the explosion-proof performance.

Before starting gas detection, check the followings.

- Check that the protective film attached on the display from shipping is removed.
- The batteries are installed (with sufficient battery level).
- The dust filter is not contaminated.
- The gas sampling probe is not loose.
- The hose clamp coupler is connected securely.

<Installing and Replacing Batteries>

When the gas detector is used for the first time, or when the battery level is low, attach new AA alkaline batteries according to the following procedures.



CAUTION

- Turn off the power of the gas detector before replacing the batteries.
- Replace the batteries in a non-hazardous area.
- Replace all of the four batteries with new ones at one time.
- Pay attention to the polarities of the batteries.
- If the battery cover is not completely locked, the dry batteries may drop off or water may get in through the clearance. Water may also get in if a minute foreign substance is caught beneath the battery unit.

- (1) Check that the power of the gas detector is turned off. * Turn off the power if it is turned on.
- (2) Release the lock and open the battery cover.
- (3) Remove old batteries and then put new batteries while observing the correct polarity.
- (4) Close the battery cover and lock it. * The lock clicks.

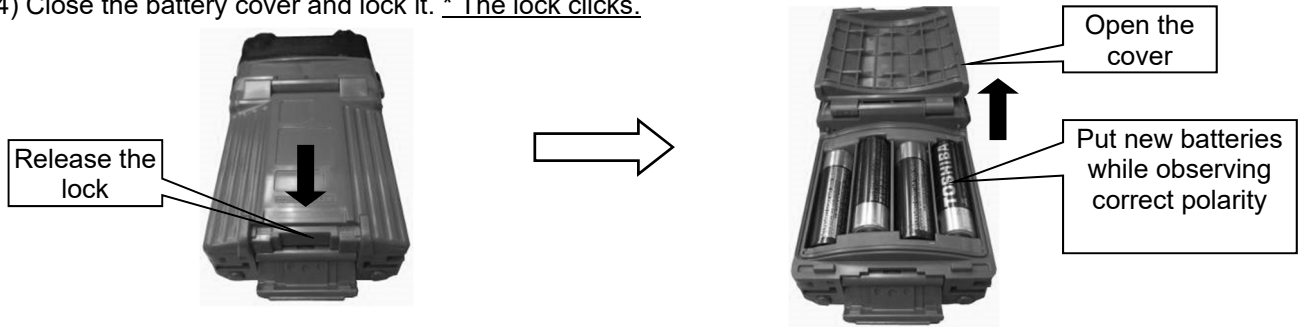

<Gas Sampling Probe Maintenance>

Check the dust filter inside the gas sampling probe visually.

- Check that the dust filter is not contaminated.
- Dust Filter Replacement Procedure
If the dust filter is contaminated, replace it following the procedure below.

(1) Hold the middle section (filter case) of the gas sampling probe and remove the tip section by turning it counterclockwise.

(2) Remove the contaminated dust filter from the middle section (filter case) and then put a new filter.
*There are no differences between the front and back sides of the dust filter.

(3) Connect the tip section by turning it clockwise.
* Tighten it securely. Loose connection may cause a leak.
* Tighten it by hand

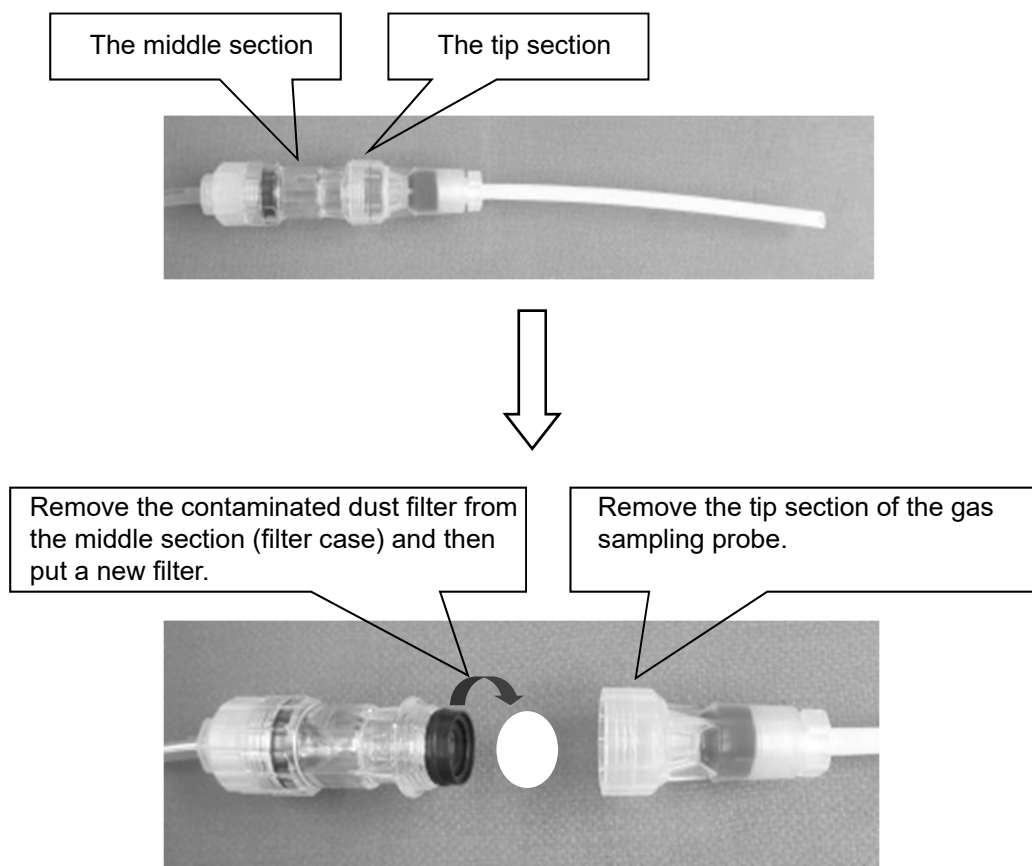

<Assembly>

Connect the gas sampling probe to the main unit as shown in the following figure.

* Insert the hose clamp coupler into the gas inlet of the main unit while pulling the release ring, and then release the release ring.

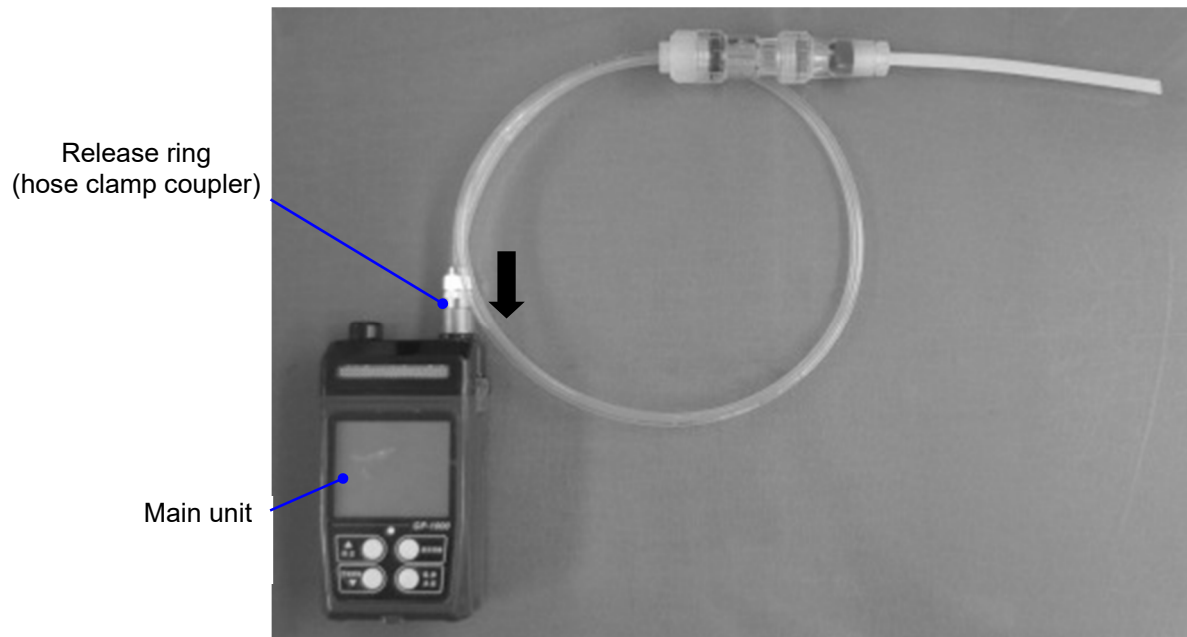

4-3. How to start the gas detector

<Power-on>

Press and hold the POWER button until the buzzer blips (one second or longer) to turn on the power. When the power is turned on, the LCD display changes automatically as shown below, and the gas detector enters the detection mode.

Start-up time (About 15 seconds)

Press and hold the POWER button for one second or longer.

All LCDs Light Up.
(Buzzer sound: Once <blip>)

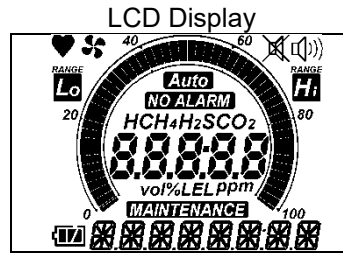

Date/time display
Display example:
June 01, 2014
8:30



Battery voltage display
Alarm type display
Display example:
6.0V
AL-H (<Self-latching>)



*Alarm type
AL-H (Alarm-Hold <Self-latching>)
AL-A (Alarm-Auto <Auto-reset>)

Gas display
Display example:
CH4

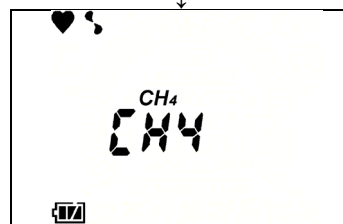

Full scale display
 Display example:
 100%LEL

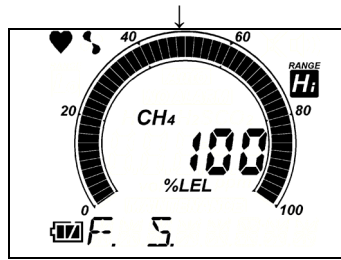

WARNING setpoint display
 Display example:
 10%LEL

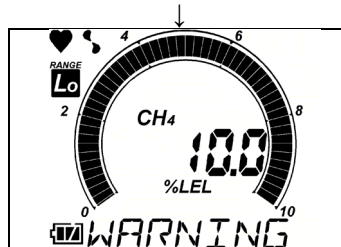

ALARM setpoint display
 Display example:
 50%LEL

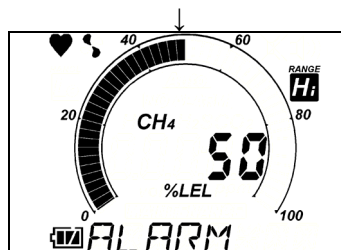

Detection mode
 (Buzzer sound: Twice <blip, blip>)

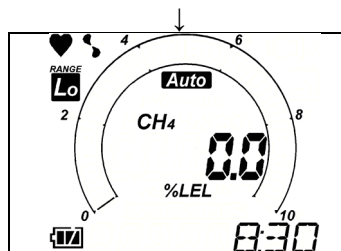

NOTE

- The range mode used at the last power off is retained.

<Basic Operating Procedures>

Normally, the detection mode is activated after the power is turned on.

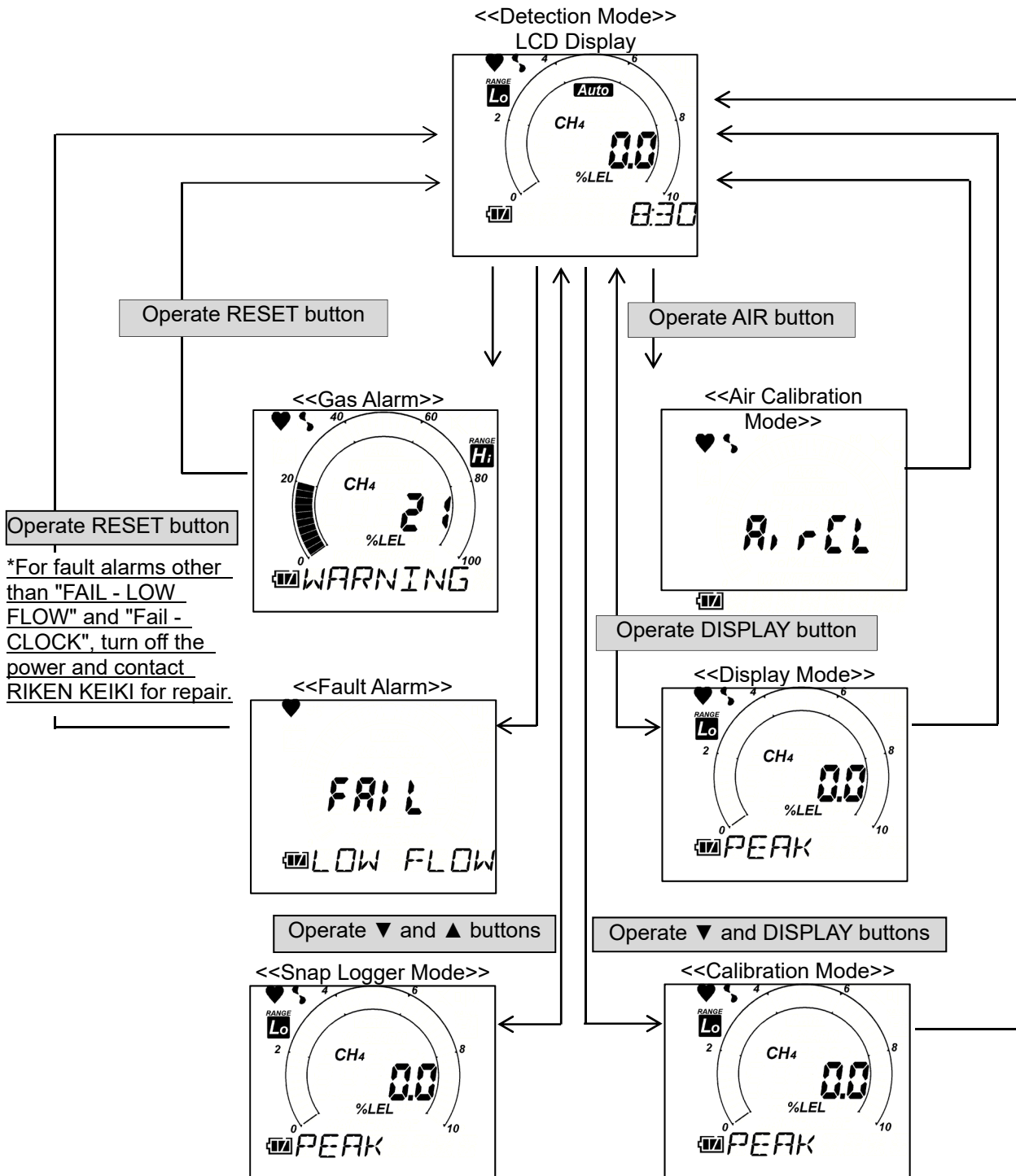

NOTE

- Of the fault alarms, only the low flow rate alarm "FAIL - LOW FLOW" can be reset by pressing the RESET button after removing the cause of low flow rate. For other fault alarms, turn off the power and then promptly contact RIKEN KEIKI for repair.
- The backlight goes off after 20 seconds or so of no operation. It lights up continuously while an alarm is activated.

<Performing Air Calibration>

Perform air calibration at maintenance before starting work or if the zero point deviates even though fresh air is drawn.

* Before performing air calibration, check that the surrounding air is fresh.

(1) Press and hold the AIR button in the detection mode.

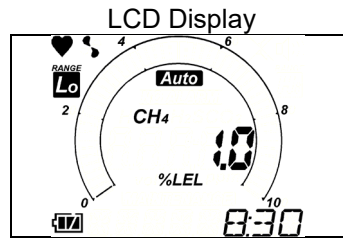

↓ [AIR]

(2) Release the AIR button when the display changes from "AirCL - HOLD AIR" to "Adj - RELEASE". (Buzzer sound: Three times <blip, blip, blip>)

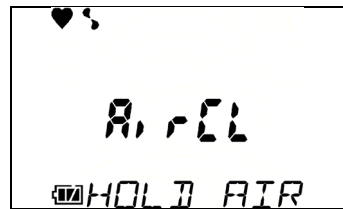

↓

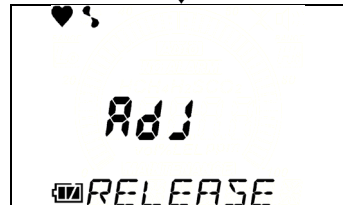

↓

The zero adjustment is done and the gas detector returns to detection mode. (Buzzer sound: Once <blip>)

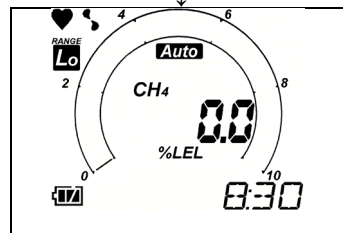

* If air calibration fails, "FAIL - AIR CAL" is displayed. Press the RESET button to reset the alarm. The gas detector returns to the detection mode (before adjustment).

NOTE

- Perform air calibration under pressure and temperature/humidity conditions close to those in the operating environment and in fresh air.
- Perform air calibration after the reading is stabilized.
- If there is a sudden temperature change of 15°C or more between the storage and operation locations, turn on the power of the gas detector, leave it for about ten minutes in a similar environment to the operation location, and perform air calibration in fresh air before using it.

4-4. How to detect

<Reading Display>

When the preparation for start-up and air calibration have been completed, put the probe close to the detection area in the detection mode and perform gas detection.

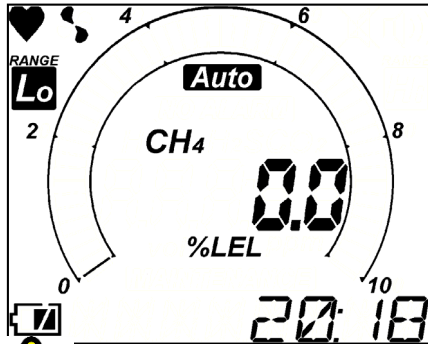

Reading display (example)

- CH4 concentration : 0.0% LEL
- Detection range: 0-10.0% LEL (Low RANGE)
- Range mode: Automatic switching (Auto)
- Battery level: Low
- Time: 18 minutes past eight in the evening



DANGER

- While conducting measurement in a manhole or confined space, do not lean over or look into the manhole or closed space. It may lead to dangers because oxygen-deficient air or other gases may blow out.
- Oxygen-deficient air or other gases may blow out from the gas exhausting outlet. Never inhale the air or gases.
- High-concentration (more than LEL) gases may blow out. Never use fire near the gas detector.



WARNING

- The gas detector is designed to draw gases around it under the atmospheric pressure. If excessive pressure is applied to the gas inlet and outlet (GAS IN, GAS OUT) of the gas detector, detected gases may leak out from its inside and may cause dangerous conditions. Be sure that excessive pressure is not applied to the gas detector while used.
- Do not connect the sampling hose directly to a location with a pressure higher than the atmospheric pressure. The internal piping system may be damaged.
- When the fresh air adjustment is performed in the atmosphere, check the atmosphere for freshness before beginning the adjustment. If other gases exist, the adjustment cannot be performed properly, thus leading to dangers when the gas leaks.
- Issuance of a gas alarm indicates that there are extreme dangers. Take proper actions based on your judgment.
- Before use, check that there remains sufficient battery power. When the gas detector is not used for a long period, the batteries may be exhausted. Replace them with new ones before use.
- If a low battery alarm occurs, gas detection cannot be conducted. If the alarm is triggered during use, turn off the power and promptly replace the batteries in a non-hazardous area.
- Do not block the buzzer sound opening. No alarm sound can be heard.

**CAUTION**

- Before performing gas detection, attach the gas sampling probe provided with the gas detector to prevent disturbances by air dust.

NOTE

- Use only a gas sampling hose specified by RIKEN KEIKI.
- Use the gas detector with the gas sampling probe connected so that no foreign substance is drawn into it.
- An oxygen concentration higher than a certain level is required for the sensor of the gas detector to correctly detect gases and display concentrations.
- Correct detection may not be performed under the presence of high-concentration combustible gas due to insufficient oxygen concentration. Once a gas exceeding 100% LEL is detected, the over display (□□□□) is held even if the combustible gas concentration drops.
- Long-time detection of a high-concentration combustible gas may adversely influence the sensor.
- In a low-temperature environment, the operating time is shortened due to the battery performance property.
- At a low temperature, the response of the LCD display may get slow down.
- If a combustible gas with a higher concentration than 100% LEL is drawn, some gas may remain in the gas sampling hose due to adsorption in the hose, gas sampling probe, etc. After drawing a high-concentration combustible gas, clean the gas detector to remove the adsorbed gas (draw fresh air and check that the reading becomes zero).

Performing fresh air adjustment before cleaning it completely will result in inaccurate adjustment, giving adverse influence on measurement. In such a case, remove the gas sampling hose before performing fresh air adjustment to avoid inaccurate adjustment.

<Snap Logger>

Any instantaneous value during measurement can be recorded.
 Up to 256 points of data can be recorded. When the number of recorded data points reaches the maximum, recorded data will be overwritten, starting from the oldest data.

Snap logger

(1) Press the ▼ and ▲ buttons to enter the snap logger mode.

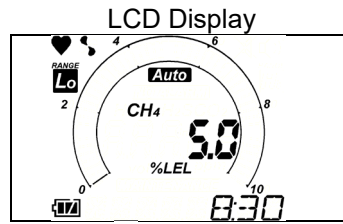

↓ [▼]+[▲]

The data number, time and concentration display are displayed for recording.

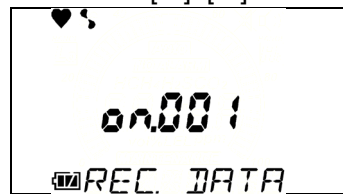

* No value is recorded at this point yet.

(2) Press the ENTER button at an appropriate timing. The time and concentration display at the time the button is pressed are recorded.

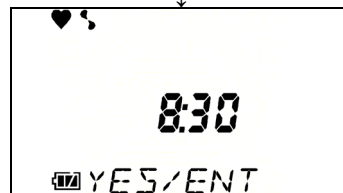

* Press the DISPLAY button to cancel the operation.



↓ [ENTER]

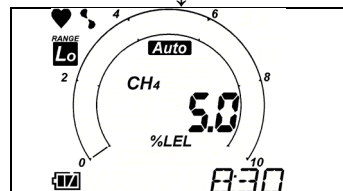
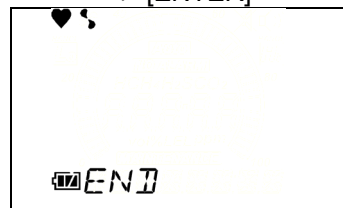

After "END" is displayed, the gas detector returns to the detection mode.

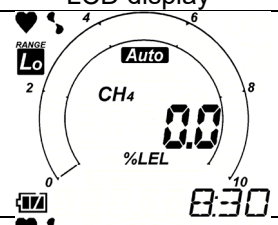
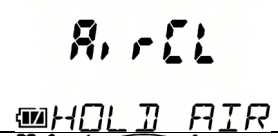
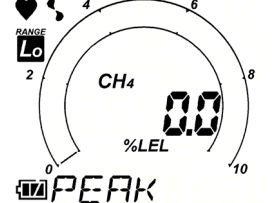
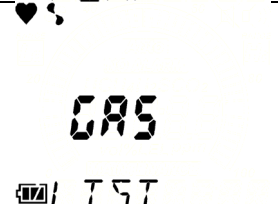
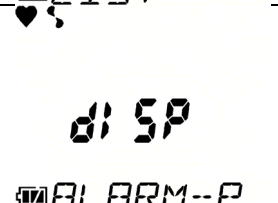
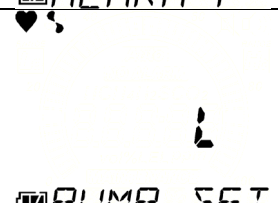
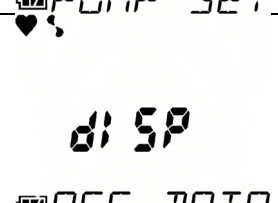
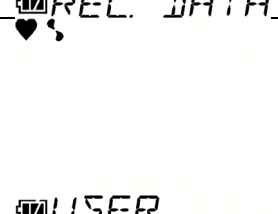

4-5. Modes

The overview of each mode is provided as follows.

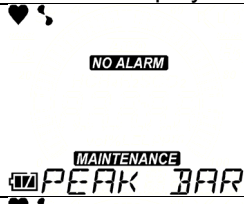
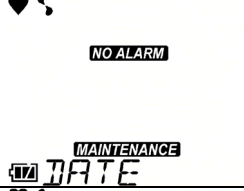
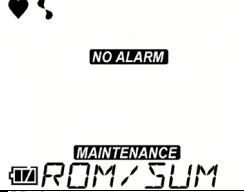
Mode	Item	LCD display	Details
Detection mode	-		Used in normal cases.
Air calibration mode	-		Performs the zero adjustment.
Display mode	Peak display		Displays the maximum concentration detected during the period from power-on to the point of checking. * <u>Press and hold the RESET button until "CLEAR - RELEASE" is displayed. The peak display can be cleared.</u>
	Concentration displayed gas reading setting		By changing the setting to the pre-registered gas in the gas detector, the converted concentration read from the detection target gas (HC or CH4) will be displayed.
	Alarm setpoint display		Displays the alarm setpoint of the gas detector. * <u>Press the ENTER button while the alarm setpoint is displayed to perform alarm test for the setting.</u>
	Pump suction volume setting		Changes (in small measure) the pump suction volume. * <u>L: Low (suction volume <low>)</u> * <u>H: High (suction volume <high>)</u>
	Log data display		The data recorded by the snap logger can be viewed.
	Entering user mode		

Mode	Item	LCD display	Details
User mode	Peak bar display setting		Turns on/off the display of blinking bar graph for the maximum concentration detected during the period from power-on to the point of checking on the bar graph.
	Date/time setting		Set the date/time of the internal clock.
	ROM/SUM display		Displays the program number and SUM value of the gas detector. * <u>This is not typically used by the user.</u>
	Entering detection mode		Enters the detection mode.

Mode	Item	LCD display	Details
Calibration mode	Bump test		Perform the bump test.
	Air calibration		Performs the zero adjustment.
	Auto calibration		Performs the span adjustment that adjusts automatically to the preset concentration of prepared span gas.
	One calibration		Performs the span adjustment that adjusts manually to the concentration of prepared span gas.
	Bump test condition setting		Sets the bump test conditions.
	Password setting		Sets a password used to protect the entry to the calibration mode.
	Entering detection mode		Enters the detection mode.

**CAUTION**

- Return to the detection mode after use. The gas detector automatically returns to the detection mode from the user or calibration mode after 15 minutes or so of no operation.
- Neither gas detection nor alarm activation occurs in the user mode and calibration mode.

NOTE

- The gas detector returns to the detection mode from the display mode after 20 seconds or so of no operation.
 - The backlight goes off after 30 seconds or so of no operation.
 - Gas detection is continued in the display mode and an alarm can be activated.
-

4-6. Display mode

4-6-1. Entering display mode

This mode can be used to display various data and change settings.

Entering display mode

Press the DISPLAY button to enter the display mode.

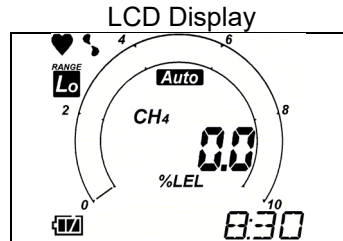

* Press the ▲ or ▼ button to select the menu and press the ENTER button for display or setting.

Peak display

Displays the maximum concentration detected during the period from power-on to the point of checking.

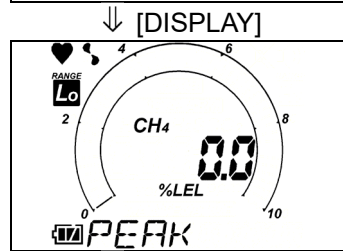

* Press and hold the RESET button until "CLEAR - RELEASE" is displayed. The peak display can be cleared.

Concentration displayed gas reading setting

A pre-registered gas can be read instead to display its concentration.

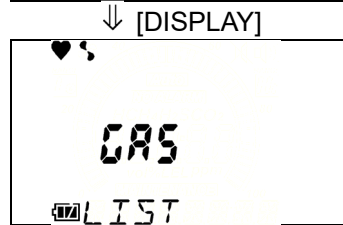

⇒ Go to "4-6-2. Concentration displayed gas reading setting".

Alarm setpoint display

The alarm setpoint display and alarm activation can be tested.



⇒ Go to "4-6-3. Alarm setpoint display".

Pump suction volume setting

The pump suction volume can be set to L: Low or H: High.

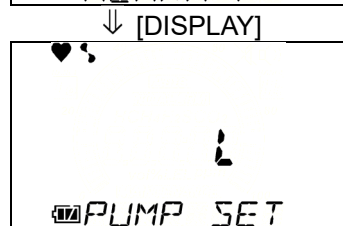

⇒ Go to "4-6-4. Pump suction volume setting".

Log data display

The data recorded by the snap logger can be viewed.

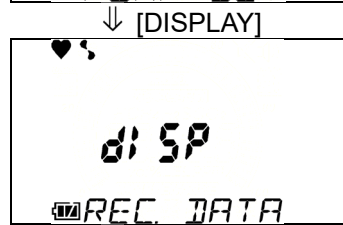

⇒ Go to "4-6-5. Log data display".

Detection mode

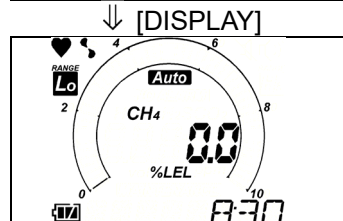

4-6-2. Concentration displayed gas reading setting

Normally, the concentration display of the gas detector is either "methane (CH4)" or "general combustible gases (HC)" depending on the specification; however, a pre-registered gas can be read instead to display its concentration.

Concentration displayed gas reading setting

(1) Press the ENTER button to enter the gas reading setting.

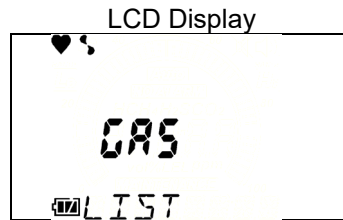

(2) Press the ▲ or ▼ button to select a gas of reading target.

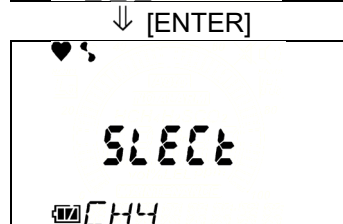

(3) Press the ENTER button to confirm the selection.



* Press the DISPLAY button to cancel the operation.

After "END" is displayed, the gas detector returns to the display mode menu.

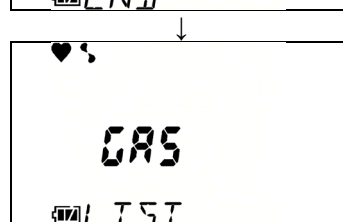
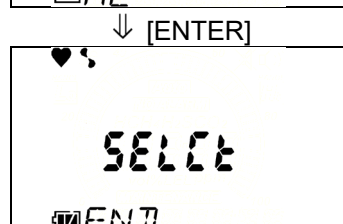

CAUTION

- To perform the concentration displayed gas reading setting, see the "GP-1000 Gas List" in the following page.
- Some gases cannot to read with an optional spiral hose. Use an appropriate hose.
- The settings made by the concentration displayed gas reading setting function are reset to the calibration gas when the power is turned off. If you wish to use the instrument again after the power is turned off, please make the readout setting again before use.

NOTE

- The alarm accuracy and alarm delay time on the specification are applied to the calibration gas (CH₄ or HC) only.
- The concentration displayed for a converted reading is a reference value. To display an accurate concentration, gas calibration using the gas to be measured is required. Therefore, request RIKEN KEIKI for calibration using the gas to be measured.
- See the following table "GP-1000 Gas List" for a list of gases available for reading.
- The gas detector provides two different specifications for target combustible gases: "general combustible gases (HC)" and "methane (CH₄)". Some gases cannot be read depending on the specification. See the following table "GP-1000 Gas List".

GP-1000 Gas List

List of gases to be read	Gas name display	Read from CH ₄ specification	Read from i-C ₄ H ₁₀ specification	Standard hose	Spiral hose (optional part)	JG specification
Methane	CH ₄	○	×	○	○	×
Isobutane	i-C ₄ H ₁₀	○	○	○	○	○
Hydrogen	H ₂	○	○	○	○	○
Methanol	CH ₃ OH	○	○	○	×	×
Acetylene	C ₂ H ₂	○	○	○	○	○
Ethylene	C ₂ H ₄	○	○	○	○	○
Ethane	C ₂ H ₆	○	×	○	○	○
Ethanol	C ₂ H ₅ OH	○	○	○	×	×
Propylene	C ₃ H ₆	○	○	○	×	○
Acetone	C ₃ H ₆ O	○	○	○	×	×
Propane	C ₃ H ₈	○	×	○	○	○
Butadiene	C ₄ H ₆	○	○	○	×	○
Cyclopentane	C ₅ H ₁₀	○	○	○	×	○
Benzene	C ₆ H ₆	○	○	○	×	×
n-Hexane	n-C ₆ H ₁₄	○	○	○	×	×
Toluene	C ₇ H ₈	○	○	○	×	×
Heptane	n-C ₇ H ₁₆	○	○	○	×	×
Xylene	C ₈ H ₁₀	○	○	○	×	×
Ethyl acetate	EtAc	○	○	○	×	×
IPA	IPA	○	○	○	×	○
MEK	MEK	○	○	○	×	×
Methyl methacrylate	MMA	○	○	○	×	×
Dimethyl ether	DME	○	○	○	×	○
Methyl isobutyl ketone	MIBK	○	○	○	×	×
Tetrahydrofuran	THF	○	○	○	×	×

**CAUTION**

- When using the gas reading setting as JG (Japanese Government) type approval specification, select gas types indicated by an "○" in the "JG specification" column. If gas types indicated by an "×" in the "JG specification" column are selected, this product does not meet the requirements of JG type approval.

4-6-3. Alarm setpoint display

The alarm setpoint display and alarm activation can be tested.

Alarm setpoint display

(1) Press the ENTER button to enter the alarm setpoint display.

(2) Press the ▲ or ▼ button to select an alarm setpoint to display.

(3) Press the DISPLAY button to return to the display mode menu.

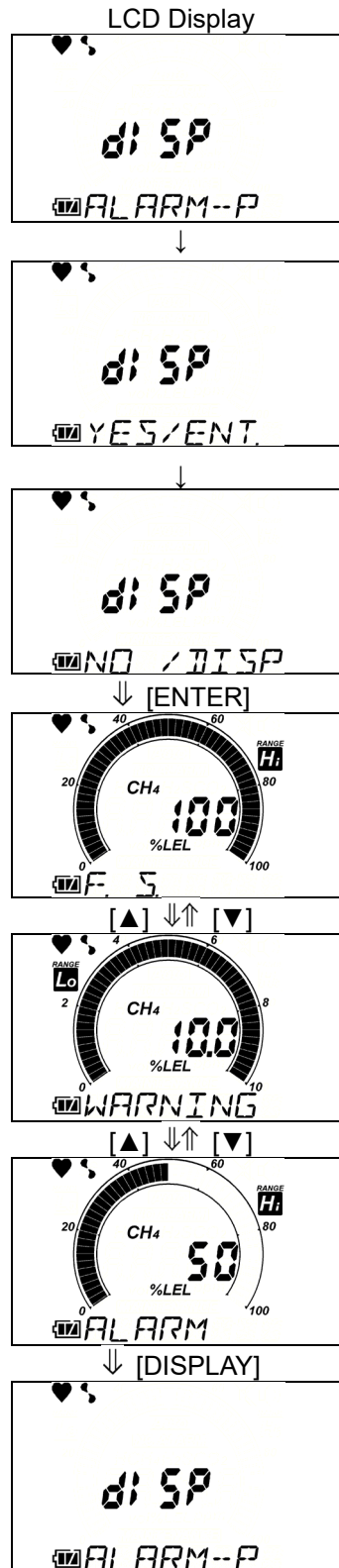

* Press the DISPLAY button to cancel the operation.

* F.S., WARNING and ALARM can be checked.

* Press the ENTER button to test the selected alarm activation. Press any button to reset the alarm.

4-6-4. Pump suction volume setting

The pump suction volume can be set to L: Low (suction volume <low>) or H: High (suction volume <high>).

Pump suction volume setting

LCD Display

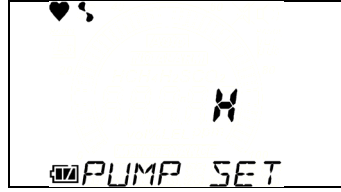
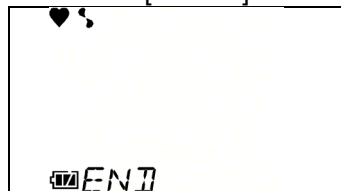
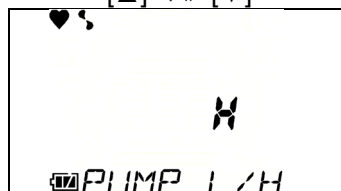
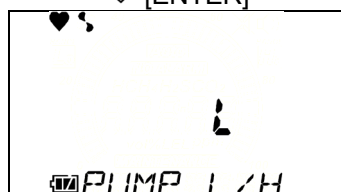
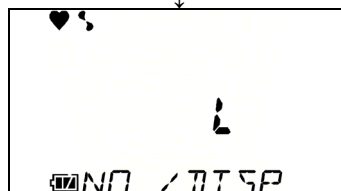
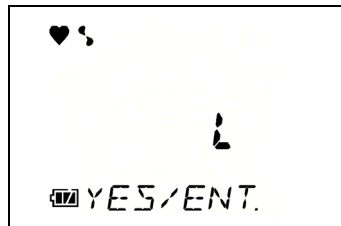
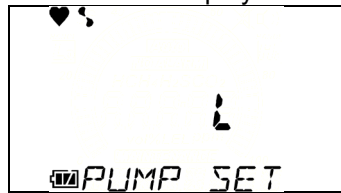

(1) Press the ENTER button to enter the pump suction volume setting.

(2) Press the ▲ or ▼ button to select the desired pump suction volume.

(3) Press the ENTER button to confirm the selection.

After "END" is displayed, the gas detector returns to the display mode menu.

* Press the DISPLAY button to cancel the operation.

* L: Low
(suction volume <low>)
H: High
(suction volume <high>)

NOTE

- When the gas detector is restarted, the pump suction volume is set to L (suction volume <low>).

4-6-5. Log data display

The data recorded by the snap logger can be viewed.

Log data display

(1) Press the ENTER button to enter the log data display.

(2) Press the ▲ or ▼ button to select the log memory number and then press the ENTER button to confirm the selection.

(3) The contents of the selected log are displayed.

(4) Press the DISPLAY button to end and return to the display mode menu.

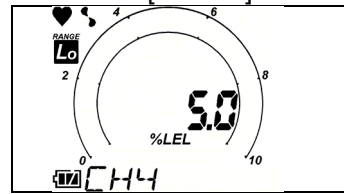
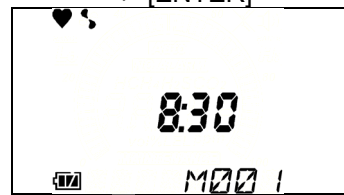
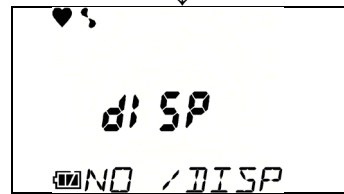
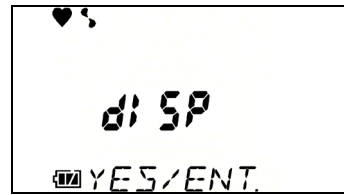
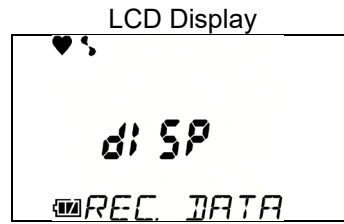

* Press the DISPLAY button to cancel the operation.

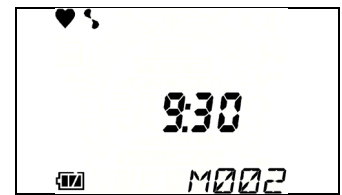

* To continue the log data display, press the ENTER button and repeat the steps from (2).

4-7. User mode

4-7-1. Entering user mode

The maintenance including internal clock correction can be performed.

Entering user mode

(1) Press the ENTER button to enter the user mode.

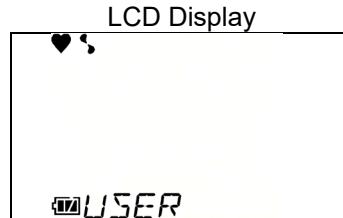

* Press the ▲ or ▼ button to select the menu and press the ENTER button to perform the setting.

Peak bar display setting

A peak of the detected gas concentration can be displayed on the bar.

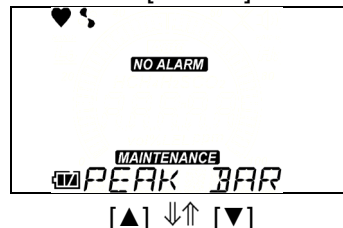

⇒ Go to "4-7-2. Peak bar display setting".

Date/time setting

Set the date/time of the internal clock.

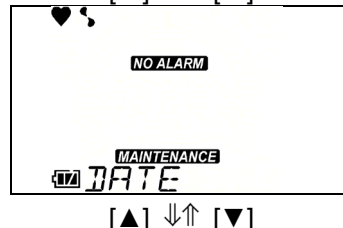

⇒ Go to "4-7-3. Date/time setting".

ROM/SUM display

The program number and SUM value of the gas detector are displayed.

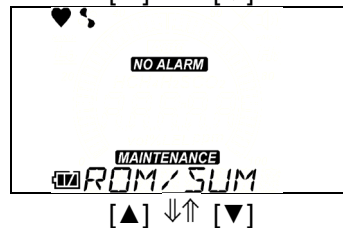

* This is not typically used by the user.

Entering detection mode

(2) To end, press the ENTER button to end and return to the detection mode.

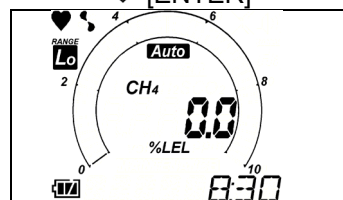
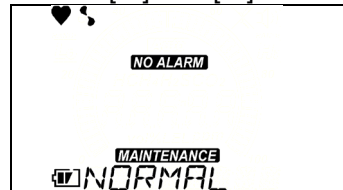

**CAUTION**

- Return to the detection mode after use. The gas detector returns to the detection mode from the user or calibration mode after 15 minutes or so of no operation.
- Neither gas detection nor alarm activation occurs in the user mode.

NOTE

- The backlight goes off after 30 seconds or so of no operation.
-

4-7-2. Peak bar display setting

A peak of the detected gas concentration can be displayed on the bar.

* This is disabled <OFF> by default.

Peak bar display setting

(1) Press the ENTER button to enter the peak bar display setting.

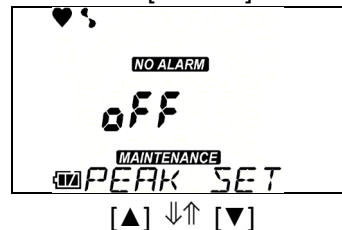
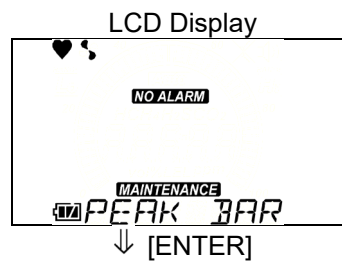

(2) Press the ▲ or ▼ button to select <on>/<OFF> for the peak bar display and then press the ENTER button to confirm the selection.

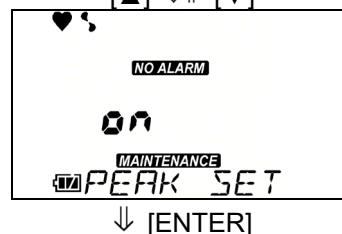

After "END" is displayed, the gas detector returns to the user mode menu.

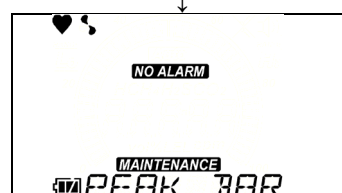
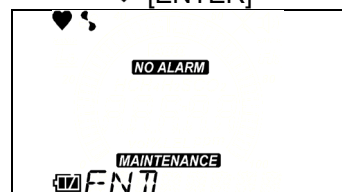

4-7-3. Date/time setting

Set the date/time of the internal clock.

Date/time setting

(1) Press the ENTER button to enter the date/time setting.

(2) Set year -> month -> day -> hour -> minute in this order. When the "minute" value is confirmed, "END" is displayed and then the gas detector returns to the user mode menu.

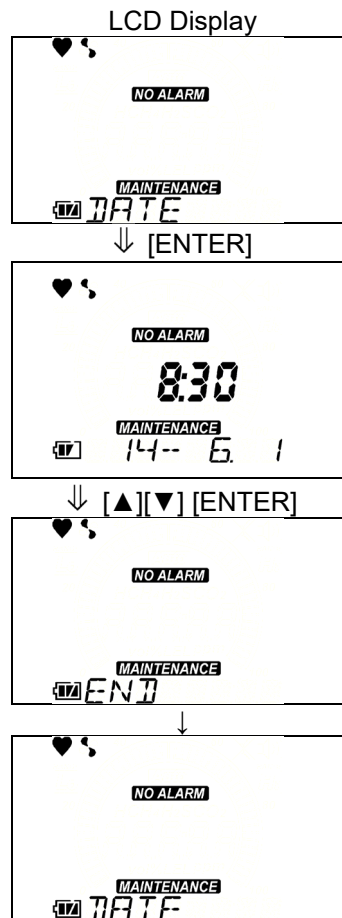

* Use the ▲ or ▼ button to adjust the date/time and press the ENTER button to confirm the setting.

4-8. Calibration mode

4-8-1. Entering calibration mode

The maintenance including bump test and air calibration can be performed.

Entering calibration mode

(1) Press and hold the **▼** and **DISPLAY** buttons together to enter the calibration mode.

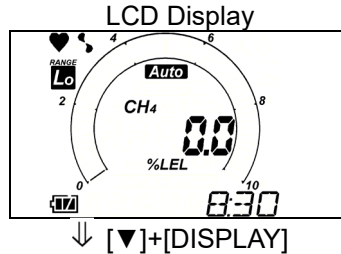

* Press the **▲** or **▼** button to select the menu and press the **ENTER** button to perform the setting.

Bump test

The function is tested using a test gas.



⇒ Go to "4-8-2. Bump test".

Air calibration

Air calibration can be performed.

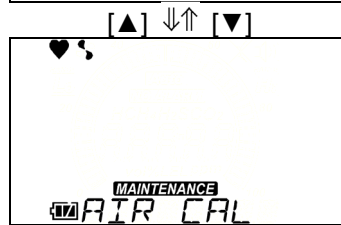

⇒ Go to "4-8-3. Air calibration".

Auto calibration

This is how to preset the concentration value of the prepared calibration gas to the gas detector and perform calibration in a single step.

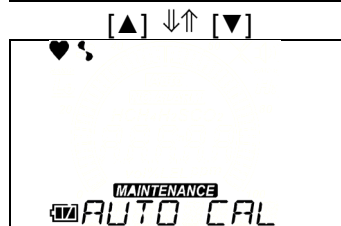

⇒ Go to "4-8-4. AUTO CAL".

One calibration

This is how to perform calibration with manually set to the concentration value of the prepared calibration gas.

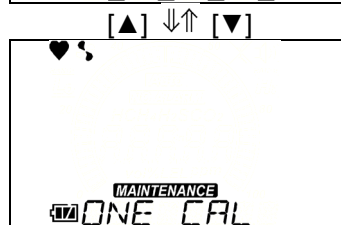

⇒ Go to "4-8-5. ONE CAL".

Bump test condition setting

Various conditions for conducting a bump test can be set.

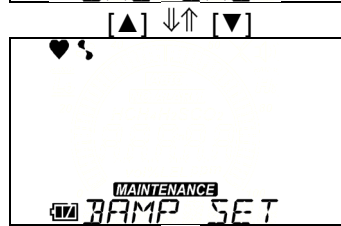

⇒ Go to "4-8-6. Bump test condition setting".

Password setting

A password can be used to protect the entry to the calibration mode.

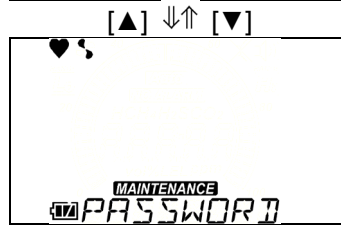

⇒ Go to "4-8-7. Password setting".

Returning to detection mode
 (2) To end, press the ENTER button and return to the detection mode.

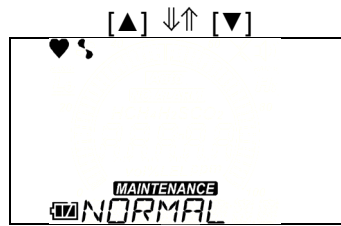

Detection mode

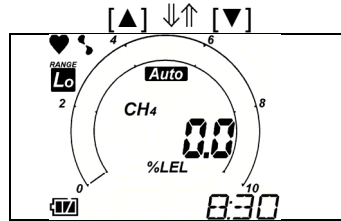

CAUTION

- Return to the detection mode after use. The gas detector returns to the detection mode from the user or calibration mode after 15 minutes or so of no operation.
- Neither gas detection nor alarm activation occurs in the calibration mode.

NOTE

- The backlight goes off after 30 seconds or so of no operation.

4-8-2. Bump test

The function is tested using a test gas. The result will be displayed as "P" (PASS) or "F" (Failure). If the function is diagnosed as "F" (Failure), take a measure such as performing span calibration.

Bump test

(1) Press the ENTER button to enter the bump test.

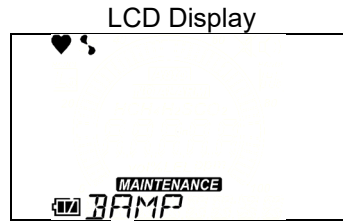

(2) Supply test gas and press the ENTER button.

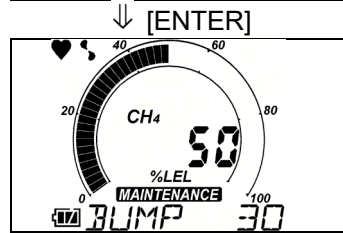

* "BUMP" and "APPLY" are displayed alternately and the countdown is started. When the count reaches zero, diagnosis is performed.

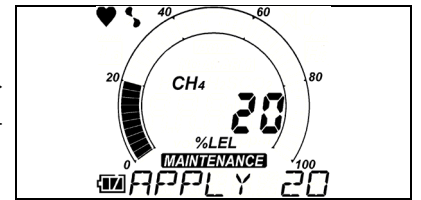
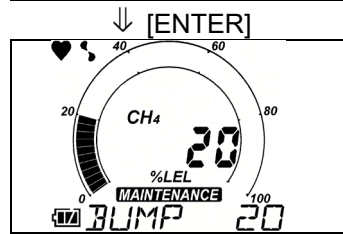

* When CAL is set to ON, "CAL" and "APPLY" are displayed alternately next and the countdown is started. When the count reaches zero, calibration is performed.

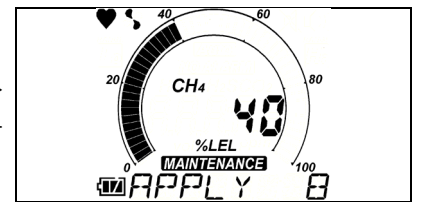
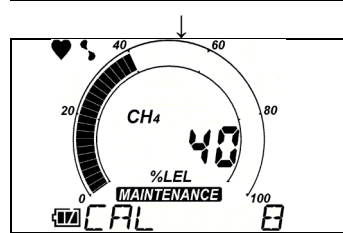

* The diagnosis result is displayed.

(3) Press the ENTER button to return to the calibration mode menu.

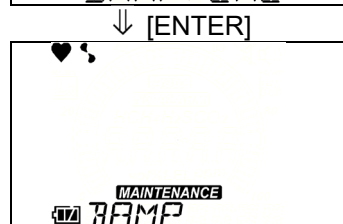
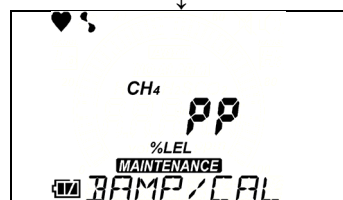

* P : PASS
F : Failure

4-8-3. Air calibration

Air calibration can be performed.

(1) Press the ENTER button.

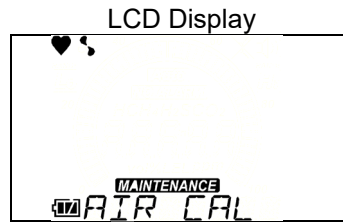

↓ [ENTER]

(2) Press and hold the AIR button and then release it when the display changes from "AirCL - HOLD AIR" to "Adj - RELEASE".
(Buzzer: Three times <blip, blip, blip>)

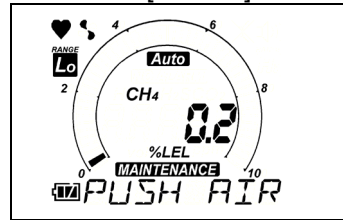

↓ [AIR]

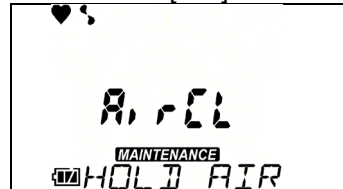

↓ [AIR]



After zero adjustment, "END" is displayed and then the gas detector returns to the calibration mode menu.
(Buzzer sound: Once <blip>)

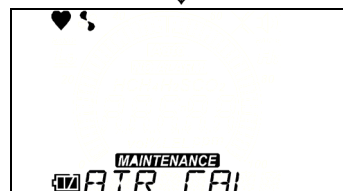

* If air calibration fails, "FAIL" is displayed. Press the RESET button to reset the alarm.

4-8-4. AUTO CAL

This is how to preset the concentration value of the prepared calibration gas to the gas detector and perform calibration in a single step.

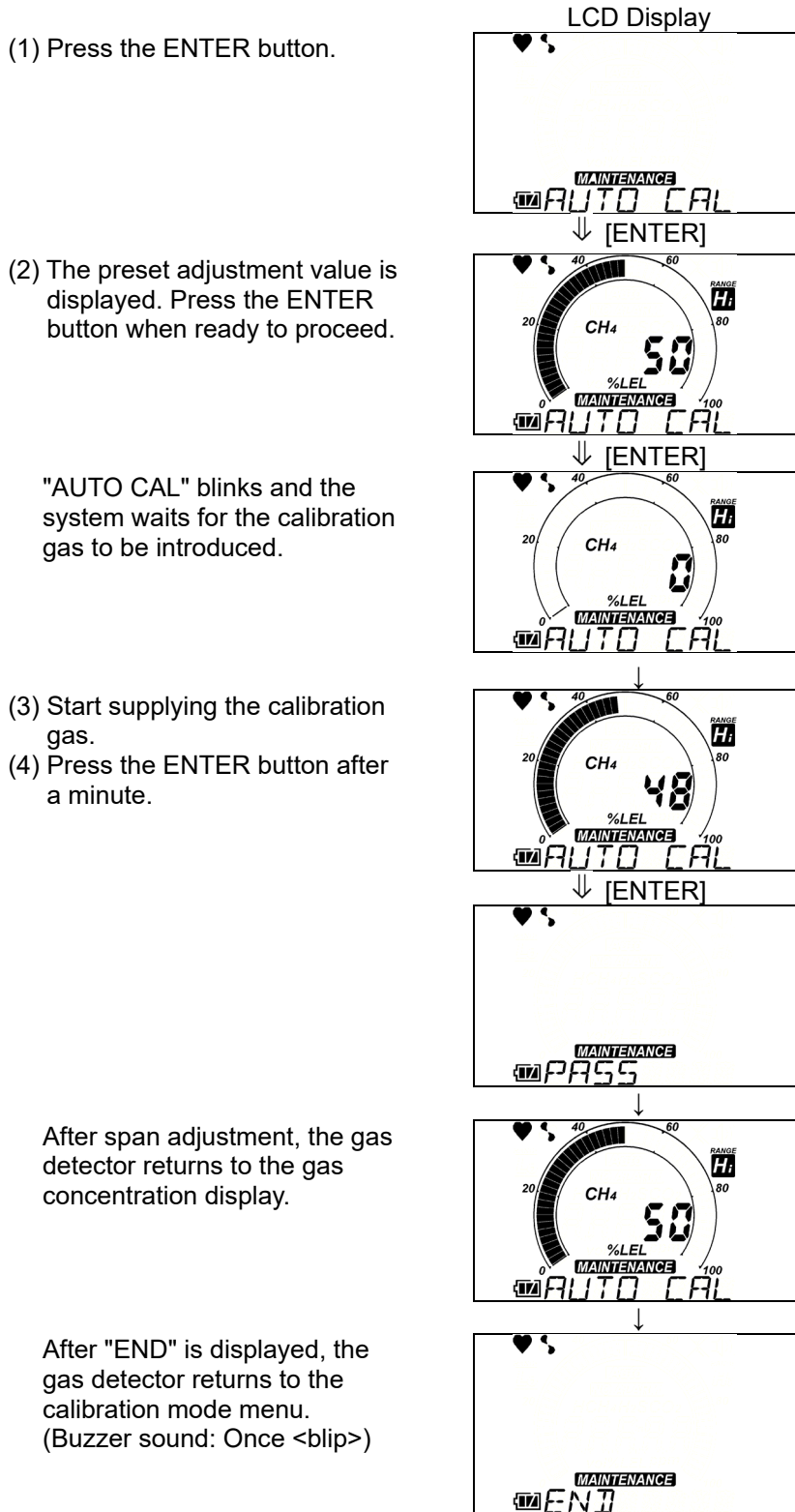

The value of AUTO CAL can be changed by using the ▼ and DISPLAY buttons.

* If span calibration fails, "FAIL" is displayed. Press the RESET button to reset the alarm.

(5) Stop supplying the calibration gas.

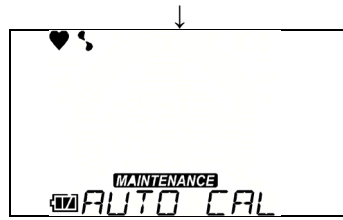

4-8-5. ONE CAL

This is how to perform calibration with manually set to the concentration value of the prepared calibration gas.

(1) Press the ENTER button.

LCD Display

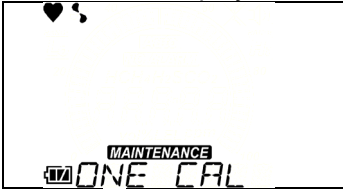

↓ [ENTER]

The concentration display blinks, and the system waits for the calibration gas to be introduced.

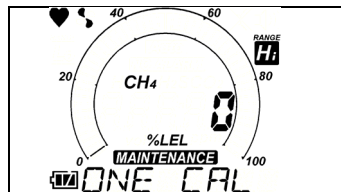

(2) Start supplying the calibration gas.

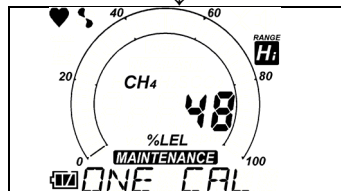

(3) After a minute, adjust the value using the ▲ or ▼ button and press the ENTER button.

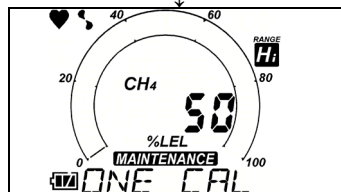

After span adjustment, "END" is displayed and then the gas detector returns to the calibration mode menu. (Buzzer sound: Once <blip>)

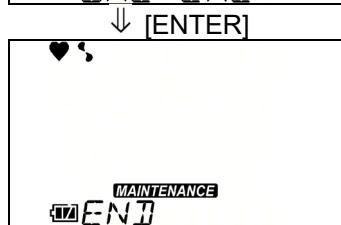

(4) Stop supplying the calibration gas.

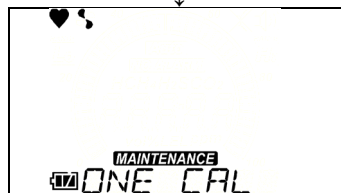

* If span calibration fails, "FAIL" is displayed. Press the RESET button to reset the alarm.

4-8-6. Bump test condition setting

Various conditions for conducting a bump test can be set.

Bump test

(1) Press the ENTER button to enter the bump test condition setting.

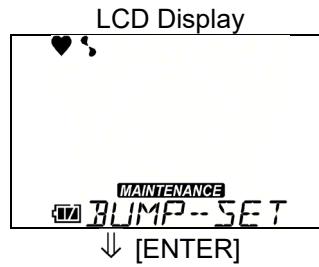

* Press the ▲ or ▼ button to select the menu and press the ENTER button to perform the setting.

(2) Set the time for introducing a test gas. Diagnosis is performed automatically when the set time has passed.

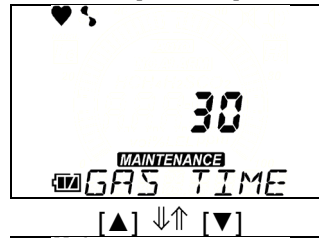

* Set range
30/45/60/90 seconds
Use the ▲ or ▼ button to select a value and press the ENTER button to confirm it.

(3) Set a threshold for checking a test gas.

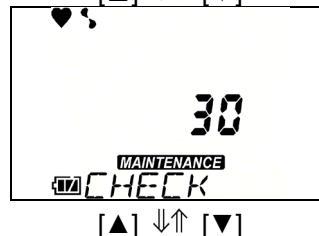

* Set range
±10/20/30/40/50%
Use the ▲ or ▼ button to select a value and press the ENTER button to confirm it.

(4) Set the calibration time. Span calibration is performed automatically when the set time has passed.

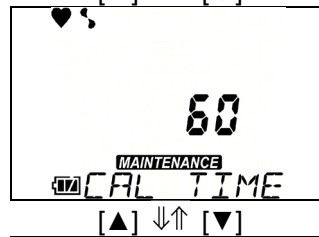

* Set range
60/90/120 seconds
Use the ▲ or ▼ button to select a value and press the ENTER button to confirm it.

(5) Set whether or not to perform span calibration after "F" (Failure) is displayed as a diagnosis.



* Set range
on: Span calibration performed
off: Span calibration not performed
Use the ▲ or ▼ button to select a value and press the ENTER button to confirm it.



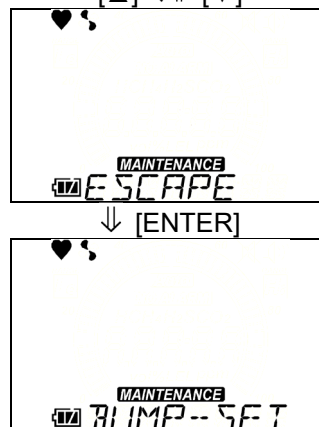

(6) Press the ENTER button while "ESCAPE" is displayed to return to the calibration mode menu.

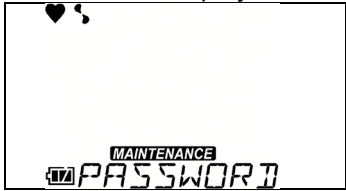
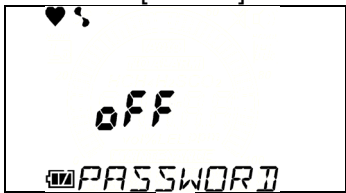

4-8-7. Password setting

A password can be used to protect the entry to the calibration mode.

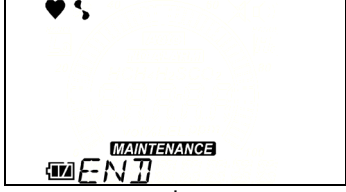
* This is disabled <OFF> by default.

(1) Press the ENTER button.	<p>LCD Display</p> 	
(2) Press the ▲ or ▼ button to select <on> or <off>.	<p>↓ [ENTER]</p> 	* <u>The state of <on> or <off> for the current password protection setting is displayed.</u>
(3) Press the ENTER button.	<p>[▲] ↓↑ [▼]</p> 	* <u>When <off> is confirmed, the gas detector returns to the calibration mode menu.</u>
(4) When <on> is selected, use the ▲ or ▼ button to select a value and press the ENTER button to confirm it.	<p>↓ [ENTER]</p> 	* <u>The password is a four-digit number. Set one digit at a time.</u>
After "END" is displayed, the gas detector returns to the calibration mode menu. (Buzzer sound: Once <blip>)	<p>↓ [▲][▼][ENTER]</p> 	
	<p>↓</p> 	

4-9. Power-off

Press and hold the POWER button (at least three seconds) until the buzzer blips four times ("TURN OFF" disappears) to turn off the power.



CAUTION

- Do not turn off the power while the gas concentration display indicates a high value. A high-concentration gas that remains in the gas detector may adversely affect the sensor.

5

Operations and Functions

5-1. Gas alarm activation

Gas alarm:	Triggered when the concentration of detected gas reaches or exceeds the alarm setpoint value.
Gas alarm activation:	Self-latching
Alarm display:	Notifies by lighting of the alarm lamp, sounding of the buzzer and blinking of the gas concentration value display.
Alarm types:	First alarm (WARNING), second alarm (ALARM) and OVER alarm

<List of Gas Alarms>

Alarm type	First alarm 10%LEL	Second alarm 50%LEL	OVER alarm 100%LEL
Alarm lamp	Repeatedly blinks at about 1 second intervals.	Repeatedly blinks at about 0.5 second intervals.	Repeatedly blinks at about 0.5 second intervals.
Buzzer	Repeatedly sounds strong and weak beeps at about 1 second intervals.	Repeatedly sounds strong and weak beeps at about 0.5 second intervals.	Repeatedly sounds strong and weak beeps at about 0.5 second intervals.
LCD display	Gas concentration and WARNING display blink.	Gas concentration and ALARM display blink.	Gas concentration and OVER display blink.

<Display Operation>

The two-step alarm is used and each of them is triggered when the respective alarm setpoint is reached or exceeded.

Gas concentration display

The gas concentration display and the alarm type display blink.

In case of exceeding the detection range, "〇〇〇" (over scale) is displayed on the LCD.

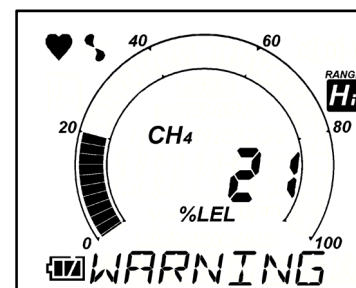

Display example

Alarm lamp and buzzer

A slow or quick intermittent operation is performed depending on the alarm type.

"Alarm Pattern"

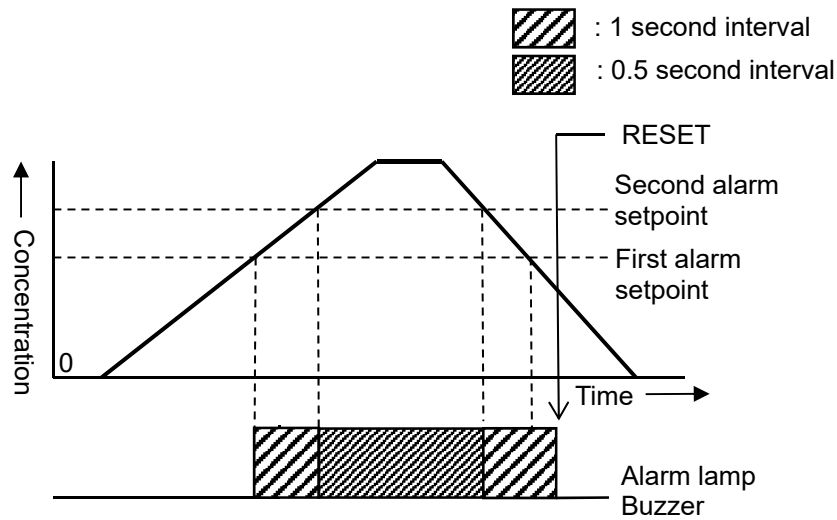
**<How to Reset the Alarm>**

After the concentration of detected gas settles below the alarm setpoint value, press the RESET button to reset the gas alarm.

NOTE

- Even if the concentration of detected gas returns to below the alarm setpoint value, the operations of buzzer, lamp and vibration continue (self-latching) until any button is pressed (the alarm is reset).
- If the concentration exceeds 100% LEL and OVER alarm is triggered, the OVER display is latched even if the detected gas concentration returns to below 100% LEL. Press the RESET button to reset the alarm. If the gas concentration is lower than the full scale at the reset, the gas concentration display appears again. If it is over the full scale, an OVER alarm occurs again.

5-2. Fault alarm activation

Fault alarm:	Triggered when an abnormality is detected in the gas detector.
Fault alarm activation:	Self-latching
Alarm display:	Notifies by lighting of the alarm lamp, sounding of the buzzer and displaying the detail.
Alarm types:	System abnormalities, sensor abnormalities, calibration abnormalities, low battery voltage, low flow rate and clock abnormalities

<Display Operation>

Alarm type	System abnormalities, sensor abnormalities, calibration abnormalities, low battery voltage, low flow rate and clock abnormalities
Alarm lamp	Blinks at about 1 second intervals.
Buzzer	Sounds intermittently at about 1 second intervals.
LCD display	Displays an error message

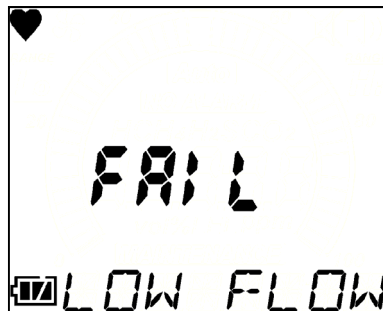

Display example (low flow rate)

NOTE

- Of the fault alarms, only the low flow rate alarm "FAIL - LOW FLOW" and "FAIL - CLOCK" can be reset by pressing the RESET button. For other fault alarms, turn off the power and then promptly contact RIKEN KEIKI.
- For information on malfunctions (error messages), see "8. Troubleshooting".

6

Maintenance

The gas detector is an important instrument for the purpose of safety. To maintain the performance of the gas detector and improve the reliability of safety, perform a regular maintenance.

6-1. Maintenance intervals and items

- Daily maintenance: Perform maintenance before beginning to work.
- Regular maintenance: Perform maintenance once or more for one year (Recommendation: once or more for six months).

Maintenance item	Maintenance content	Daily maintenance	Regular maintenance
Battery level	Check that the battery level is sufficient.	○	○
Tube	Check for cracks and holes.	○	○
Filter	Check that the filter is not contaminated.	○	○
Operation of main unit	Check the LCD display for a fault indication.	○	○
Concentration display	Make the gas detector draw in fresh air and check that the concentration display value is zero. When the value is other than zero, perform zero calibration after ensuring that no other gases exist around the gas detector.	○	○
Span adjustment	Perform the span adjustment by using the calibration gas.	—	○
Gas alarm check	Check the gas alarm by using the calibration gas.	—	○

NOTE

- The span adjustment requires dedicated equipment and creation of calibration gas. Therefore, request RIKEN KEIKI for span adjustment
 - The built-in sensor of the gas detector has a validity period and must be replaced regularly.
 - The sensor life has expired if, for example, the sensors cannot be calibrated in span adjustment, the readings do not come back after fresh air adjustment, or the readings fluctuate. Request RIKEN KEIKI for repair. Note that the warranty period is one year.
-

6-2. How to clean

Clean the gas detector if it becomes extremely dirty. The gas detector must be turned off while cleaning it. Use a waste cloth to remove dust. Do not use water or organic solvent for cleaning because they may cause malfunctions.



CAUTION

When cleaning the gas detector, do not splash water over it or use organic solvents such as alcohol and benzene on it. It may cause discoloration or damage to the surface or sensor failure.

6-3. Replacement of consumables

<List of Recommended Regular Replacement Parts>

No.	Name	Recommended maintenance interval	Recommended replacement interval	Quantity (pieces per unit)	Remarks
1	Pump unit	6 months	1 to 2 years	1	RP-12*
2	Gas sensor	6 months	3 years	1	NC-6215*
3	Rubber seals	-	2 years	1	*
4	Dust filter	Before and after use	Before and after use	1	
5	Alkaline dry battery	-	-	4	

* The operation must be checked after replacement by a qualified service engineer. For the stable operation of the gas detector and safety, ask a qualified service engineer to take care of replacement of the parts whose operation must be checked. Request RIKEN KEIKI for operation check.

NOTE

The above replacement intervals are recommendation only. The intervals may change depending on the operating conditions. These intervals do not mean the warranty periods either. The result of the regular maintenance may determine when to replace the parts.

<Battery Replacement>

See "4-2. Preparation for start-up <Installing and Replacing Batteries>" for the battery replacement procedure.

<Filter>

See "4-2. Preparation for start-up <Gas Sampling Probe Maintenance>" for dust filter replacement procedure.



CAUTION

- Never fail to turn off the power of the gas detector before replacing the dust filter.
- Use the dedicated dust filter for this gas detector only. The use of similar products may cause inaccurate gas detection.

6-4. Air calibration

<Performing Air Calibration>

Perform air calibration at maintenance before starting work or if the zero point deviates even though fresh air is drawn. * Before performing air calibration, check that the surrounding air is fresh.

See "4-3. How to start the gas detector <Performing Air Calibration>" or "4-8-3. Air calibration" for the procedure.

6-5. Span calibration

<Preparation for Span Calibration>

- Calibration gas CH₄ or i-C₄H₁₀ (*1, *2)
50±5% LEL (recommended)
- Gas sampling bag (*2)
- Stopwatch

*1 Depend on the type of gas detector.

*2 Optional parts

<Connection>

Connect the gas detector as shown in the figure below.
Connect a gas sampling bag at an appropriate timing.

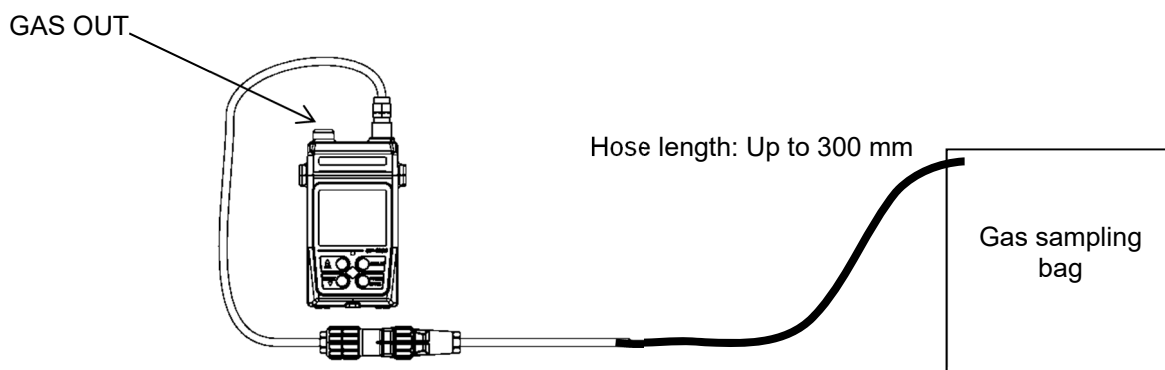

<Performing Span Calibration>

Perform span calibration in a single step using the concentration of the prepared calibration gas preliminarily set to the gas detector, or perform it manually by adjusting to the concentration of the prepared calibration gas.

See "4-8-4. AUTO CAL" or "4-8-5. ONE CAL" for the procedure.



CAUTION

Do not use a lighter gas to check the sensitivity of the gas detector. A constituent of the lighter gas may deteriorate the sensor performances.

7

Storage and Disposal

7-1. Procedures to store the gas detector or leave it for a long time

The gas detector must be stored under the following environmental conditions.

- In a dark place under the normal temperature and humidity away from direct sunlight
- In a place where gases, solvents or vapors are not present

Store the gas detector in a shipping carton, if any, in which the product was delivered.
Store the gas detector away from dust, etc. if the shipping carton is not available.



CAUTION

- If the gas detector is not used for a long time, store it after removing the batteries. Battery leaks may result in fire, injury, etc.
- If the gas detector is not used for a long time, turn on the power at least once every six months and check that the pump draws in air (about three minutes). The gas detector, when not activated for a long time, may cease to work because of hardening of the grease in the pump motor.

7-2. Procedures to use the gas detector again



CAUTION

When using a stopped or stored gas detector again, never fail to perform a gas calibration. Contact RIKEN KEIKI for readjustment including gas calibration.

7-3. Disposal of products

When the gas detector is disposed of, it must be treated properly as an industrial waste in accordance with the local regulations.



WARNING

- Dispose of the batteries in accordance with procedure specified by the local authority.

- When disposing of the gas detector in EU member states, sort the batteries as specified. Handle the removed batteries according to the classified refuse collection system and recycling system based on the regulations of EU member states.

Removing batteries

See "4-2. Preparation for start-up <Installing and Replacing Batteries>" to take out the batteries.

Used batteries

Model	Type
LR6	Alkaline dry battery

NOTE

- The gas detector contains batteries.
- Crossed-out recycle dustbin mark

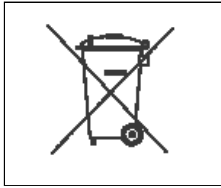

This symbol mark is indicated on the products which contain the batteries which fall under EU Battery Directive 2006/66/EC. Such batteries need to be disposed of as specified by the latest Directive. This symbol mark indicates that the batteries need to be separated from the ordinary waste and disposed of appropriately.

8

Troubleshooting

The troubleshooting does not explain the causes of all the malfunctions which occur on the gas detector. This simply helps to find the causes of malfunctions which frequently occur. If the gas detector shows a symptom which is not explained in this manual, or still has malfunctions even though remedial actions are taken, please contact RIKEN KEIKI.

<Abnormalities on Unit>

Symptoms	Causes	Actions
<u>The power cannot be turned on.</u>	The battery level is too low.	Replace all the four batteries with new ones.
	The POWER button was released quickly.	For power-on, keep the POWER button pressed until a beep is heard.
	Batteries are not installed properly.	Check that the batteries are properly installed to the main unit.
<u>Abnormal operations</u>	Disturbances by sudden static electricity noise, etc.	Turn off and restart the gas detector.
<u>Key operations are disabled.</u>	Disturbances by sudden static electricity noise, etc.	Remove the batteries and install them again and then turn on the power to perform operations.
<u>System abnormalities</u> FAIL - SYS***	A circuit abnormality occurred.	Record the display content "FAIL - SYS****" and then contact RIKEN KEIKI for repair.
<u>Low battery voltage alarm</u> FAIL - BATTERY	The battery level is low.	Turn off the power and then replace the batteries with new ones.
<u>Zero adjustment failure (inaccurate adjustment)</u>	Surrounding air was not fresh at zero adjustment.	Press the RESET button to reset the alarm. Supply fresh air and then perform zero adjustment again.
<u>Sensor abnormalities</u> FAIL - SENSOR	A sensor has failed.	Request RIKEN KEIKI to replace the sensor.
<u>Low flow rate alarm</u> FAIL - LOW FLOW	The flow rate has decreased due to clogs at the sampling part, bended hose, etc.	After eliminating the cause for clogging, bending, etc., press the RESET button to reset the alarm.
	The pump has failed.	Request RIKEN KEIKI to replace the pump.
	The unit was stored for a long time without being used (6 months or longer).	When the low flow rate alarm is displayed, turn off the unit once and then on again. Repeat this procedure several times. If the problem still persists, request RIKEN KEIKI to replace the pump.
<u>Clock abnormalities</u> FAIL - CLOCK	The clock function has failed.	Request RIKEN KEIKI for repair.

<Abnormalities of Readings>

Symptoms	Causes	Actions
<u>The reading rises and it remains so.</u>	Drifting of sensor output	Perform zero adjustment.
	A high-concentration combustible gas has been drawn.	Supply fresh air and leave the unit for a while.

9

Product Specifications

<List of Specifications>

Model	GP-1000
Gas to be detected	Combustible gas (CH ₄ , HC, etc. See the separate list for target gases) *1
Detection principle	New ceramic catalytic type
Measurement range	0-100%LEL
Alarm type	Gas Alarm: Self-latching, two-step alarm Fault alarm: Low flow rate, poor sensor connection, low battery voltage, circuit abnormality and calibration range abnormality
Alarm operation	Gas Alarm: Intermittent buzzer sound, blinking alarm lamp (red) and blinking gas concentration display Fault alarm: Intermittent buzzer sound, blinking alarm lamp (red) and fault detail display
Alarm setpoint	1st: 10% LEL, 2nd: 50% LEL
Accuracy of the reading	±5% of full scale (under the same conditions)
Response time	90% response: Within 30 seconds
Alarm delay time	30 seconds or less
Detection method	Pump suction type with a flow rate of 0.3 L/min or more (pump L mode)
Display	LCD seven-segment numeric display, bar meter display (50 divisions) and status information display Seven-segment digital display : 0-100% LEL Digital bar meter display : Auto range switching L range: 0-10% LEL (Resolution:0.1% LEL) H range: 0-100% LEL (Resolution:1% LEL)
Power supply	4 AA alkaline dry batteries*2
Continuous operating time	20 hours or more (new dry batteries, without alarms or lighting, at 25°C)
Operating environment	Operating temperature range: -20 - +50°C operating humidity range: Below 95% RH (Non-condensing)
External dimensions	Approx. 80 (W) x 124 (H) x 36 (D) mm (projection portions excluded)
Weight	Approx. 260 g (without batteries)
Drip-proof and dust-proof performances	Compliant to IP67
Explosion-proof performance	Intrinsically safe explosion-proof structure II 1G Ex ia IIB T4 Ga(ATEX/UKEX) / Ex ia IIB T4 Ga(IECEx) / Ex ia IIC T4(Japan Ex)
Functions	LCD backlight, data logger, log data display, peak display, switching pump performance between strong and weak, changing a reading target gas
Standard accessories	Power supply : 4 AA alkaline dry batteries Storage : Hand strap Sampling : Gas sampling hose (1 m) and sampling probe

9 Product Specifications

Optional accessories	30 m hose, dedicated leather case, diluter, spiral hose Data logger management program
----------------------	---

*1 The factory default setting is either CH4 or HC (specified in the order).

*2 To meet the requirements for explosion-proof performance, use the batteries specified in the certification of explosion-proof electrical equipment.



EU-Declaration of Conformity

Document No.: 320CE22089



We, RIKEN KEIKI Co., Ltd. 2-7-6, Azusawa, Itabashi-ku, Tokyo, 174-8744 Japan declare under our sole responsibility that the following product conforms to all the relevant provisions.

Product Name: Portable Combustible Gas Detector
Model: GP-1000

Council Directives		Applicable Standards
2014/30/EU	EMC Directive	EN 50270:2015
2014/34/EU	ATEX Directive	EN IEC 60079-0:2018 EN 60079-11:2012
2011/65/EU ^[1]	RoHS Directive	EN IEC 63000:2018

^[1]Including substances added by Commission Delegated Directive (EU) 2015/863

EU-Type examination Certificate No. DEKRA 13ATEX0227

Notified Body for ATEX DEKRA Certification B.V. (NB 0344)
Meander 1051, 6825 MJ Arnhem
P.O.Box 5185, 6802 ED Arnhem
The Netherlands

Auditing Organization for ATEX DNV Product Assurance AS (NB 2460)
Veritasveien 1
1363 Høvik
Norway

The marking of the product shall include the following:

 II 1 G Ex ia IIB T4 Ga

Place: Tokyo, Japan

Date: Jun. 29, 2022

Takakura Toshiyuki
General manager
Quality Control Center



UK-Declaration of Conformity

Document No. 320UK23016



We, RIKEN KEIKI Co., Ltd. 2-7-6, Azusawa, Itabashi-ku, Tokyo, 174-8744, Japan declare under our sole responsibility that the following product conforms to all the relevant provisions.

Product Name Portable Combustible Gas Detector
Model GP-1000

Regulations	UK designated Standards
Electromagnetic Compatibility Regulations 2016 (S.I. 2016/1091)	BS EN 50270:2015
The Equipment and Protective Systems Intended for Use in Potentially Explosive Atmospheres Regulations 2016 (S.I. 2016/1107) (UKEX)	BS EN IEC 60079-0:2018 BS EN 60079-11:2012
The Restriction of the Use of Certain Hazardous Substances in Electrical and Electronic Equipment Regulations 2012 (S.I. 2012/3032)	BS EN IEC 63000:2018

UK-Type examination Certificate No.

DEKRA 21UKEX0363

Approved Body for UKEX

DEKRA Certification UK Ltd (AB8505)
Stokenchurch House, Oxford Road,
Stokenchurch, Buckinghamshire HP14 3SX,
United Kingdom

Auditing Organization for UKEX

DNV Business Assurance UK Ltd (AB8501)
4th Floor Vivo Building, 30 Stamford Street,
London SE1 9LQ, United Kingdom

The marking of the product shall include the following



II 1 G Ex ia IIB T4 Ga

Place: Tokyo, Japan

Date: Aug. 31, 2023

Takakura Toshiyuki
General manager
Quality Control Center