



PT0E-10710

**Portable Multi-Gas Monitor**  
**GX-2012 Series**  
**GX-2012**  
**GX-2012GT**  
**Operating Manual**  
**(PT0-107)**

**RIKEN KEIKI Co., Ltd.**

2-7-6 Azusawa, Itabashi-ku, Tokyo, 174-8744, Japan

Phone : +81-3-3966-1113

Fax : +81-3-3558-9110

E-mail : [intdept@rikenkeiki.co.jp](mailto:intdept@rikenkeiki.co.jp)

Web site : <https://www.rikenkeiki.co.jp/>

## Safety information

### <ATEX/IECEX/UKEX specifications>

The Portable Gas Monitor Model GX-2012 is a gas monitor designed to provide continuous exposure monitoring of combustible gas (LEL,VOL), oxygen (O<sub>2</sub>), toxic gas such as carbon monoxide (CO) and hydrogen sulfide (H<sub>2</sub>S) in hazardous environments. Model GX-2012GT is a gas monitor designed to provide continuous exposure monitoring of combustible gas (ppm,LEL,VOL), oxygen (O<sub>2</sub>), toxic gas such as carbon monoxide (CO).

The gas sample is sucked in by build-in micro pump.

The battery can be selected either Li-ion battery or alkaline dry battery.

Li-ion battery unit is called BUL-2012,BUL-2012(G1) and alkaline dry battery unit is called BUD-2012.

The battery unit can be changed even by the end users.

### Specification for safety

•Ex ia IIC T4 Ga (without combustible LEL gas sensor)

•Ex ia IIB T4 Ga (with combustible LEL gas sensor)



II 1 G Ex ia IIC T4 Ga (without combustible LEL gas sensor)

II 1 G Ex ia IIB T4 Ga (with combustible LEL gas sensor)

•Ambient temperature range for use : -20 °C to +50 °C

•Ambient temperature range during battery charging : 0 °C to +40 °C

### Electrical data

•Power supply of Li-ion battery unit : BUL-2012,BUL-2012(G1)

Powered by single Li-ion cell is from type Maxell INR18650PB1 or SDI INR1865015M or SONY US18650VT3. Um=17.8V,

to be charged with exclusive charger model BC-2012 or SDM-2012

•Power supply of alkaline battery unit : BUD-2012

Powered by three series AA size alkaline batteries, model LR6 by TOSHIBA.

•Backup battery type CR1220 manufactured by Maxell.

### Certificate numbers

•IECEX Certificate number : IECEX DEK 11.0045

•ATEX Certificate number : DEKRA 11ATEX 0123

•UKEX Certificate number : DEKRA 21UKEX 0364

### List of standards

•IEC 60079-0: 2017

•EN IEC 60079-0:2018

•BS EN IEC 60079-0:2018

•IEC 60079-11: 2011

•EN 60079-11:2012

•BS EN 60079-11:2012

### WARNING

•Do not charge in hazardous location.

•Use exclusive charger , model BC-2012 or SDM-2012.

•Do not replace battery unit in hazardous location.

•Do not replace dry batteries in hazardous location.

•Do not attempt to disassemble or alter the instrument.

•Use only battery unit type BUD-2012 with three series connected Alkaline

AA batteries, type LR6 manufactured by Toshiba, or use chargeable battery unit

type BUL-2012,BUL-2012(G1).

INST. No. 0 0 0 0 0 0 0 0 0 0  
                  A B C D E

A: Manufacturing year (0-9)

B: Manufacturing month (1-9,XYZ for Oct.-Dec.)

C: Manufacturing lot

D: Serial number

E: Code of factory



**RIKEN KEIKI Co.,Ltd.**

2-7-6 Azusawa, Itabashi-ku, Tokyo, 174-8744, Japan

Phone : +81-3-3966-1113

Fax : +81-3-3558-9110

E-mail : [intdept@rikenkeiki.co.jp](mailto:intdept@rikenkeiki.co.jp)

Web site : <https://www.rikenkeiki.co.jp/>

---

## <Contents>

1. Outline of the Product.....	2
1-1. Preface.....	2
1-2. Purpose of use.....	2
1-3. Definition of DANGER, WARNING, CAUTION, and NOTE.....	3
1-4. Method of confirmation for Standards and Explosion proof specification.....	3
2. Important Notices on Safety.....	4
2-1. Danger cases.....	4
2-2. Warning cases.....	6
2-3. Precautions.....	7
3. Product Components.....	9
3-1. Main unit and standard accessories.....	9
3-2. Names and functions for each part.....	11
4. How to Use.....	15
4-1. Before using the gas monitor.....	15
4-2. Preparation for start-up.....	15
4-3. Basic operating procedures.....	19
4-4. How to start the gas monitor.....	21
4-5. How to detect.....	25
4-6. Modes.....	30
4-7. Air calibration mode.....	32
4-8. Display/setting mode.....	34
4-9. How to exit.....	44
5. Operations and Functions.....	45
5-1. Gas alarm activation.....	45
5-2. Fault alarm activation.....	47
5-3. Other functions.....	48
6. Maintenance.....	50
6-1. Maintenance intervals and items.....	50
6-2. Gas calibration method.....	51
6-3. How to clean.....	52
6-4. Parts replacement.....	52
7. Storage and Disposal.....	55
7-1. Procedures to store the gas monitor or leave it for a long time.....	55
7-2. Procedures to use the gas monitor again.....	55
7-3. Disposal of products.....	56
8. Troubleshooting.....	57
9. Product Specifications.....	60
9-1. List of specifications.....	60
9-2. List of accessories.....	64
10. Definition of Terms.....	65

---

# 1

---

# Outline of the Product

## 1-1. Preface

Thank you for choosing our portable multi-gas monitor GX-2012 series. Please check that the model number of the product you purchased is included in the specifications on this manual.

This manual explains how to use the gas monitor and its specifications. It contains information required for using the gas monitor properly. Not only the first-time users but also the users who have already used the product must read and understand the operating manual to enhance the knowledge and experience before using the gas monitor.

Product specifications may be abbreviated in this document as follows.

Japan Ex specification : Japan specification

ATEX / IECEx / UKEX specifications : Export specification



## 1-2. Purpose of use

This gas monitor is a multi gas type that enables simultaneous monitoring of all of the following five types of gases (up to 4 types of gases, excluding hydrogen sulfide, with GX-2012GT) at the maximum: oxygen, combustible gases, and toxic gases (carbon monoxide and hydrogen sulfide) in the air and high-concentration combustible gases (vol%) in N<sub>2</sub> and inert gases. The gas monitor can measure two types of combustible gases, "general combustible gases (HC)," which are used in ordinary factories, oil tankers, etc. and "methane (CH<sub>4</sub>)," such as city gas and natural gas.

Detection results are not intended to guarantee life or safety in any way.

The gas monitor comes in several types for different combinations of gases to be detected. Check the specifications of the gas monitor before use and conduct gas detection properly in accordance with purposes. (See the list of gases to be detected at the end of this operating manual)  
In addition to this operating manual, an operating manual for the data logger management program (optional) is available for the gas monitor. Contact RIKEN KEIKI, if it is needed.

## 1-3. Definition of DANGER, WARNING, CAUTION, and NOTE

 <b>DANGER</b>	This message indicates that improper handling may cause serious damage on life, health or assets.
 <b>WARNING</b>	This message indicates that improper handling may cause serious damage on health or assets.
 <b>CAUTION</b>	This message indicates that improper handling may cause minor damage on health or assets.
<b>NOTE</b>	This message indicates advice on handling.

## 1-4. Method of confirmation for Standards and Explosion proof specification

This instrument has some specification depends on standard and explosion proof certificate. Please confirm the detector specification before using. Please refer Declaration of Conformity that is at the end of this manual if you have CE/UKCA marking type.

You can confirm instrument specification to see name plate as follows.

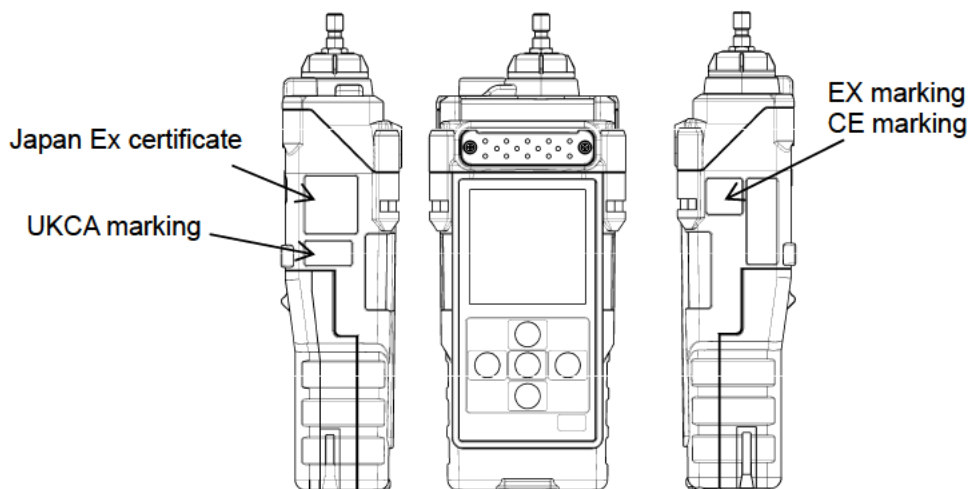

Name plate attachment position

## 2

# Important Notices on Safety

## 2-1. Danger cases



**DANGER**

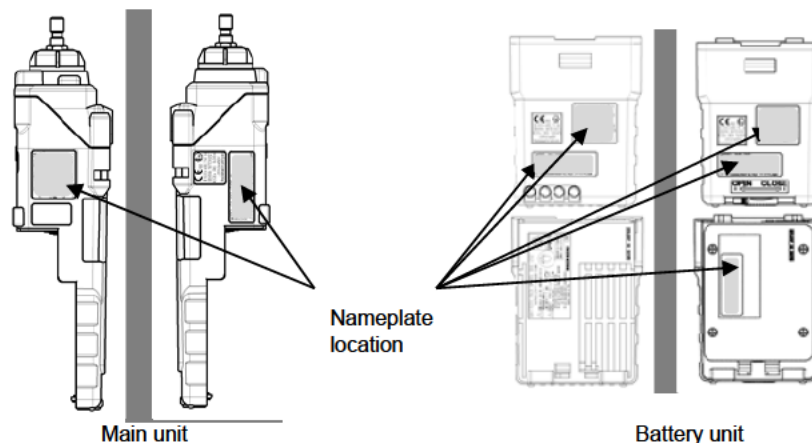

### About explosion-proof of main unit

- Do not modify or change the circuit or structure, etc.
- When measuring the oxygen concentration, do not measure anything but a mixture of air and combustible gases or vapors and toxic gases.
- When using this gas monitor in a hazardous area, take the following countermeasures for preventing dangers resulting from electrostatic charges.
  - (1) Wear anti-static clothes and conductive shoes (anti-static work shoes).
  - (2) For indoor use, use the gas monitor while standing on a conductive work floor (with a leakage resistance of 10 MΩ or less).
- Only the following battery unit can be connected: BUD-2012(certification number TC20171) or BUL-2012(certification number TC20209), BUL-2012(G1)(certification number TC21258).
- The specifications of the gas monitor are as follows:
  - Pump circuit: Allowable voltage of 4.95 V, allowable current of 0.808 A, and allowable power of 0.826 W
  - Main circuit: Allowable voltage of 4.95 V, allowable current of 1.009 A, and allowable power of 1.032 W
  - Buzzer circuit: Allowable voltage of 4.95 V, allowable current of 0.451 A, and allowable power of 0.462 W
  - Backup circuit: 3.0 VDC, 10 μA
  - Ambient temperature: -20 °C - +50 °C
- IP protection class of main units are IP20.



## DANGER

### About explosion-proof of battery unit

- Do not modify or change the circuit or structure, etc.
- When using this gas monitor in a hazardous area, take the following countermeasures for preventing dangers resulting from electrostatic charges.
  - (1) Wear anti-static clothes and conductive shoes (anti-static work shoes).
  - (2) For indoor use, use the gas monitor while standing on a conductive work floor (with a leakage resistance of 10 MΩ or less).
- Do not replace dry battery in non-hazardous location.
- Do not replace battery unit in non-hazardous location.
- Only the following main unit can be connected: GX-2012, GX-2012GT (certification number TC20170). Inappropriate combinations of models deviate from the range of explosion-proof certification.
- The specifications of dry battery unit (BUD-2012) is as follows:
 

Explosion-proof grade:	Ex ia II C T4
Maximum voltage:	4.95 V
Power supply:	4.5 VDC, 250 mA (Type LR6 manufactured by Toshiba, 3 pcs)
Ambient temperature:	-20 °C - +50 °C
- The specifications of lithium ion battery unit (BUL-2012, BUL-2012(G1)) are as follows:
 

Pump circuit:	Maximum voltage of 4.25 V, maximum current of 0.768 A, and maximum power of 618 W
Main circuit:	Maximum voltage of 4.25 V, maximum current of 0.984 A, and maximum power of 793 W
Buzzer circuit:	Maximum voltage of 4.25 V, maximum current of 0.410 A, and maximum power of 330 mW
Maximum voltage:	4.25 V
Explosion-proof grade:	Ex ia II C T4
Ambient temperature:	-20 °C - +50 °C
Battery charging contact:	Allowable voltage of 17.8 V, Allowable current of 2.72 A
- IP protection class of battery units are IP20.

### About combination

- Make sure that the product model on the nameplate is correct. Inappropriate combinations of models deviate from the range of explosion-proof certification. The nameplate shows the followings as well as the product model.
 

Product model:	Main unit GX-2012, GX-2012GT Dry battery unit BUD-2012 Lithium ion battery unit BUL-2012, BUL-2012(G1)
Manufacture:	RIKEN KEIKI Co., LTD.
Explosion-proof grade:	Ex ia II C T4 X (GX-2012, GX-2012GT) Ex ia II C T4 (BUD-2012, BUL-2012, BUL-2012(G1))
Ambient temperature:	-20 °C - +50 °C
Warnings:	Inhibit to take off battery unit in non-hazardous area. (GX-2012, GX-2012GT) Inhibit to take off dry battery in non-hazardous area. (GX-2012, GX-2012GT, BUD-2012)
- Powered by three series connected Alkaline AA batteries, type LR6 manufactured by Toshiba.

### About use

- While conducting measurement in a manhole or confined space, do not lean over or look into the manhole or closed space. It may lead to dangers because oxygen-deficient air or other gases may blow out.
- Oxygen-deficient air or other gases may blow out from the gas exhausting outlet. Never inhale the air or gases.
- High-concentration (100 %LEL or higher) gases may be discharged. Never use fire near the gas monitor.

## 2-2. Warning cases



### WARNING

#### Sampling point pressure

- The gas monitor is designed to draw gases around it under the atmospheric pressure. If excessive pressure is applied to the gas inlet and outlet (GAS IN, GAS OUT) of the gas monitor, detected gases may be leaked from its inside, thus leading to danger. Avoid applying excessive pressure to the gas monitor while in use.
- Do not connect the taper nozzle directly to a location with a pressure higher than the atmospheric pressure. The internal piping system may be damaged.

#### Handling of sensor

Do not disassemble the electrochemical type sensor or galvanic cell type sensor because they contain electrolyte. Electrolyte may cause severe skin burns if it contacts skin, while it may cause blindness if it contacts eyes.

If electrolyte is adhered on your clothes, that part on your clothes is discolored or its material is decomposed. If contact occurs, rinse the area immediately with a large quantity of water.

#### Fresh air adjustment in atmosphere

When the fresh air adjustment is performed in the atmosphere, check the atmosphere for freshness before beginning the adjustment. If other gases exist, the adjustment cannot be performed properly, thus leading to dangers when the gas leaks.

#### Response to gas alarm

Issuance of a gas alarm indicates that there are extreme dangers. Take proper actions based on your judgment.

#### Battery level check

- Before use, check that there remains sufficient battery power. When the gas monitor is used for the first time or is not used for a long period, the batteries may be exhausted. Either replace the batteries with new ones or fully charge them before use.
- If a low battery voltage alarm is triggered, gas detection cannot be conducted. If the alarm is triggered during use, turn off the power and promptly replace (recharge) the batteries in a non-hazardous area.

#### Others

- Do not throw the gas monitor into fire.
- Do not wash the gas monitor in a washing machine or ultrasonic cleaner.
- Do not block the buzzer sound opening. No alarm sound can be heard.
- Do not remove the battery unit while the power is ON.
- Do not remove the battery unit in a hazardous location.
- Do not remove the dry batteries in a hazardous location.



## 2-3. Precautions



### CAUTION

**Do not use the gas monitor where it is exposed to oil, chemicals, etc. Do not submerge the gas monitor under water on purpose.**

- Do not use in a place where the gas monitor is exposed to liquids such as oil and chemicals.
- The gas monitor, being compliant to IP67, is not water-pressure-resistant. Do not use the gas monitor where a high water pressure is applied to it (under a faucet, shower, etc.) or submerge it under water for a long time. The gas monitor is water-proof only in fresh water and running water, and not in hot water, salt water, detergent, chemicals, human sweat, etc.
- The gas inlet and outlet are not water-proof. Be careful not to let water such as rainwater get into these parts. Because this may cause trouble and gas cannot be detected.
- Do not place the gas monitor where water or dirt gets accumulated. The gas monitor placed at such a location may malfunction due to water or dirt that gets into the buzzer opening, gas inlet, etc.
- Note that drawing in dirty water, dust, metallic powder, etc. will significantly deteriorate the sensor sensitivities. Be careful when the gas monitor is used in an environment where these elements exist.

**Do not use the gas monitor in a place where the temperature drops below -20 °C or rises over 50 °C.**

- The operating temperature of the gas monitor is -20 - 50 °C. Do not use the gas monitor at higher temperatures, humidity, and pressures or at lower temperatures than the operating range.
- Avoid long-term use of the gas monitor in a place where it is exposed to direct sunlight.
- Do not store the gas monitor in a sun-heated car.

**Observe the operating restrictions to prevent condensation inside the gas monitor.**

Condensation formed inside the gas monitor causes clogging or gas adsorption, which may disturb accurate gas detection. Thus, condensation must be avoided. In addition to the installation environment, carefully monitor the temperature/humidity of the sampling point to prevent condensation inside the gas monitor. Please observe the operating restrictions.

**Do not use a transceiver near the gas monitor.**

- Radio wave from a transceiver near the gas monitor may disturb readings. If a transceiver or other radio wave transmitting device is used, it must be used in a place where it disturbs nothing.
- Do not use the gas monitor near a device that emits strong electromagnetic waves (high-frequency or high-voltage devices).

**Verify that the pump operating status indicator is rotating before using the gas monitor.**

If the pump operation status indicator is not rotating, gas detection cannot be performed properly. Check whether the flow rate is lost.

**Verify that the driving status indicator is blinking before using the gas monitor.**

If the driving status indicator is not blinking, gas detection cannot be performed properly.

**Never fail to perform a regular maintenance.**

Since this is a safety unit, a regular maintenance must be performed to ensure safety. Continuing to use the gas monitor without performing maintenance will compromise the sensitivity of the sensor, thus resulting in inaccurate gas detection.



## CAUTION

### Others

- Pressing buttons unnecessarily may change the settings, preventing alarms from activating correctly. Operate the gas monitor using only the procedures described in this operating manual.
- Do not drop or give shock to the gas monitor. The water-proof and explosion-proof properties and accuracy may be deteriorated.
- Do not use the gas monitor while charging it.
- Whereas the gas monitor can detect oxygen, combustible gases, carbon monoxide, and hydrogen sulfide, the operating environment may include gases that have harmful effects on the sensors of this unit. (Different gases can be detected depending on the type).

The gas monitor cannot be used in the presence of the following gases:

- (1) Sulfides (such as  $\text{H}_2\text{S}$  and  $\text{SO}_2$ ) continuously existing in high concentrations
- (2) Halogen gases (such as chloride compounds and chlorofluorocarbons)
- (3) Silicone (Si compounds)

Do not use the gas monitor in the presence of the above gases (such as high-concentration sulfides, halogen gases, and silicone), which may shorten the sensor life significantly or cause malfunctions such as inaccurate readings.

In case the gas monitor is used for detection in the presence of silicone, etc., be sure to check the gas sensitivities before using it again.

## 3

# Product Components

## 3-1. Main unit and standard accessories

After opening the package, check the main unit and accessories.  
If anything in the following list is not included, contact RIKEN KEIKI.

<p>&lt;Main Unit&gt;</p> <p>GX-2012 Series Main Unit</p>  <p>Dry battery unit (BUD-2012)</p>	<p>&lt;Standard Accessories&gt;</p> <ul style="list-style-type: none"> <li>Alkaline dry batteries: 3</li> <li>Taper nozzle: 1</li> <li>Hand strap: 1</li> <li>Operating manual</li> <li>Product warranty</li> </ul> 
--	--



### DANGER

#### About explosion-proof of main unit

- Do not modify or change the circuit or structure, etc.
- When measuring the oxygen concentration, do not measure anything but a mixture of air and combustible gases or vapors and toxic gases.
- When using this gas monitor in a hazardous area, take the following countermeasures for preventing dangers resulting from electrostatic charges.
  - Wear anti-static clothes and conductive shoes (anti-static work shoes).
  - For indoor use, use the gas monitor while standing on a conductive work floor (with a leakage resistance of 10 MΩ or less).
- Only the following battery unit can be connected: BUD-2012(certification number TC20171) or BUL-2012(certification number TC20209), BUL-2012(G1)(certification number TC21258).
- The specifications of the gas monitor are as follows:
  - Pump circuit: Allowable voltage of 4.95 V, allowable current of 0.808 A, and allowable power of 0.826 W
  - Main circuit: Allowable voltage of 4.95 V, allowable current of 1.009 A, and allowable power of 1.032 W
  - Buzzer circuit: Allowable voltage of 4.95 V, allowable current of 0.451 A, and allowable power of 0.462 W
  - Backup circuit: 3.0 VDC, 10 μA
  - Ambient temperature: -20 °C - +50 °C
- IP protection class of main units are IP20.



## DANGER

### About explosion-proof of battery unit

- Do not modify or change the circuit or structure, etc.
- When using this gas monitor in a hazardous area, take the following countermeasures for preventing dangers resulting from electrostatic charges.
  - (1) Wear anti-static clothes and conductive shoes (anti-static work shoes).
  - (2) For indoor use, use the gas monitor while standing on a conductive work floor (with a leakage resistance of 10 MΩ or less).
- Do not replace dry battery in non-hazardous location.
- Do not replace battery unit in non-hazardous location.
- Only the following main unit can be connected: GX-2012, GX-2012GT (certification number TC20170). Inappropriate combinations of models deviate from the range of explosion-proof certification.
- The specifications of dry battery unit (BUD-2012) are as follows:
 

Explosion-proof grade:	Ex ia II C T4
Maximum voltage:	4.95 V
Power supply:	4.5 VDC, 250 mA (Type LR6 manufactured by Toshiba, 3 pcs)
Ambient temperature:	-20 °C - +50 °C
- The specifications of lithium ion battery unit (BUL-2012, BUL-2012(G1)) are as follows:
 

Pump circuit:	Maximum voltage of 4.25 V, maximum current of 0.768 A, and maximum power of 618 W
Main circuit:	Maximum voltage of 4.25 V, maximum current of 0.984 A, and maximum power of 793 W
Buzzer circuit:	Maximum voltage of 4.25 V, maximum current of 0.410 A, and maximum power of 330 mW
Maximum voltage:	4.25 V
Explosion-proof grade:	Ex ia II C T4
Ambient temperature:	-20 °C - +50 °C
Battery charging contact:	Allowable voltage of 17.8 V, Allowable current of 2.72 A
- IP protection class of battery units are IP20.

### About combination

- Make sure that the product model on the nameplate is correct. Inappropriate combinations of models deviate from the range of explosion-proof certification. The nameplate shows the followings as well as the product model.
 

Product model:	Main unit GX-2012, GX-2012GT Dry battery unit BUD-2012 Lithium ion battery unit BUL-2012, BUL-2012(G1)
Manufacture:	RIKEN KEIKI Co., LTD.
Explosion-proof grade:	Ex ia II C T4 X (GX-2012, GX-2012GT) Ex ia II C T4 (BUD-2012, BUL-2012, BUL-2012(G1))
Ambient temperature:	-20 °C - +50 °C
- Warnings: Inhibit to take off battery unit in non-hazardous area. (GX-2012, GX-2012GT)  
Inhibit to take off dry battery in non-hazardous area. (GX-2012, GX-2012GT, BUD-2012)
- Powered by three series connected Alkaline AA batteries, type LR6 manufactured by Toshiba.

## 3-2. Names and functions for each part

### <Outline Drawing> (Main Unit)

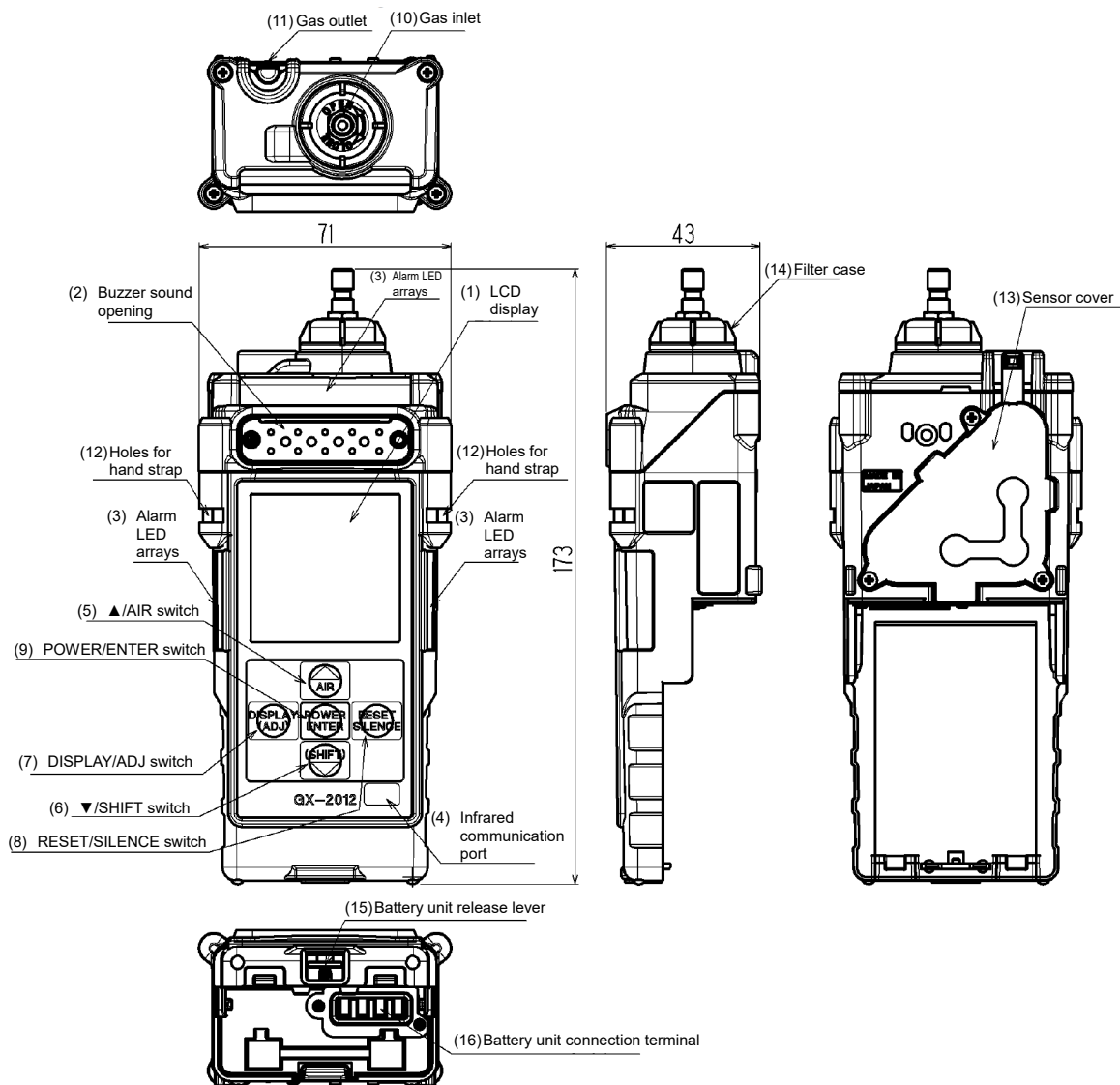

(1)	LCD display	Displays gas concentrations, alarms, etc.
(2)	Buzzer sound opening	Emits a buzzer sound at an alarm. (Do not block this opening)
(3)	Alarm LED arrays	The lamp blinks in response to an alarm.
(4)	Infrared communication port	Used to carry out data communications with a PC in data logger mode.
(5)	▲/AIR switch	Used to move from menu to menu in normal order, and to perform the fresh air adjustment by pressing the switch long, in the display/setting mode.
(6)	▼/(SHIFT)switch	Used to move from menu to menu in reverse order in the display/setting mode.
(7)	DISPLAY/ADJ switch	Used to switch to the display/setting mode, etc.
(8)	RESET/SILENCE switch	Used to check and to reset the alarm.
(9)	POWER/ENTER switch	Used to turn on and off the power and to confirm the setting in the display/setting mode.
(10)	Gas inlet	Connecting port for the taper nozzle.
(11)	Gas outlet	Gas outlet, from which gas drawn into the gas monitor is discharged. (Do not block the outlet)
(12)	Holes for hand strap (2 positions)	Holes for hand strap. Two holes, one each for right and left.
(13)	Sensor cover	There is a sensor inside. (May be opened only when the sensor is to be replaced)
(14)	Filter case	Contains a dust filter inside. (Do not remove the case except for maintenance and replacement)
(15)	Battery unit release lever	Lever which is used to remove the battery unit.
(16)	Battery unit connection terminal	Terminal which connects the main unit and the battery unit.



**CAUTION**

- Do not jab the buzzer sound opening with a sharp-pointed item. The unit may malfunction or get damaged, allowing water or foreign substance, etc. to get inside.
- Do not remove the panel sheet on the surface. The water-proof and dust-proof performances will be deteriorated.
- Do not affix a label on the infrared communication port. Infrared communications can no longer be conducted.

<Outline Drawing> (Battery Unit)

Dry battery unit (BUD-2012)

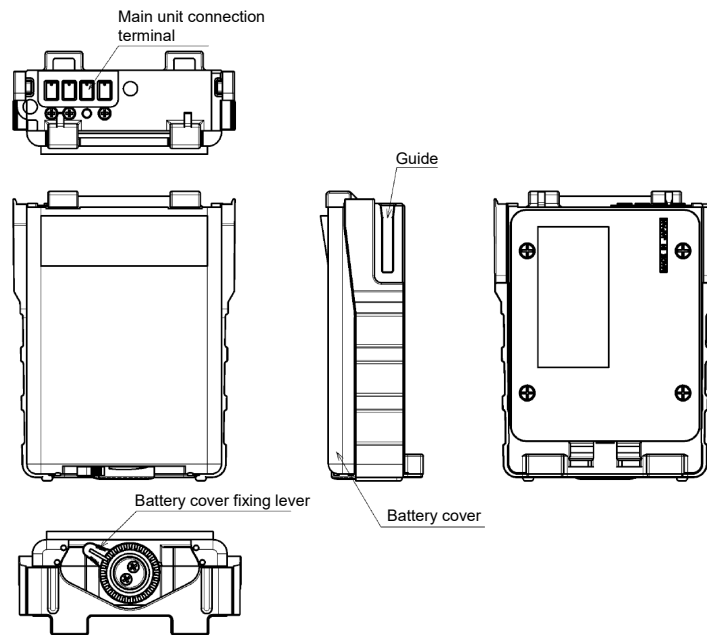

Lithium ion battery unit: BUL-2012, BUL-8000(G1) (Option)

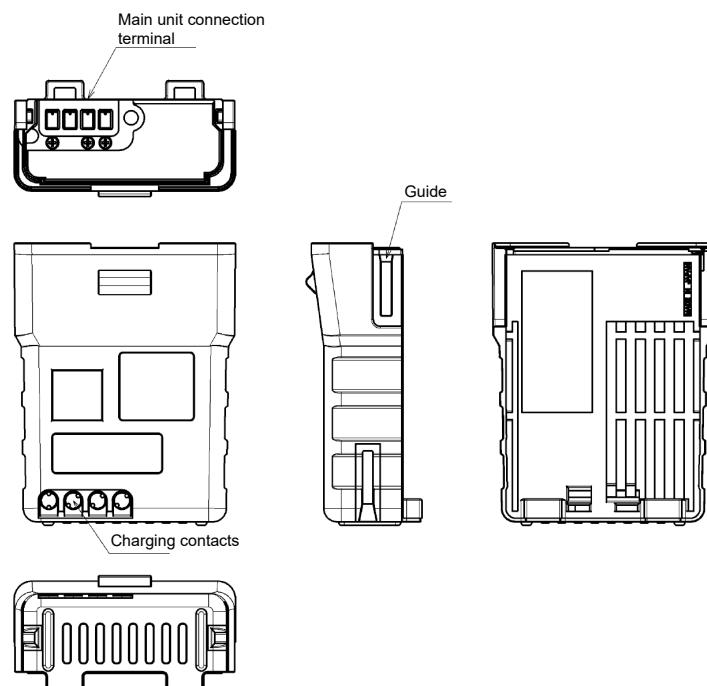

<LCD Display>

GX-2012

GX-2012GT <Normal Mode>

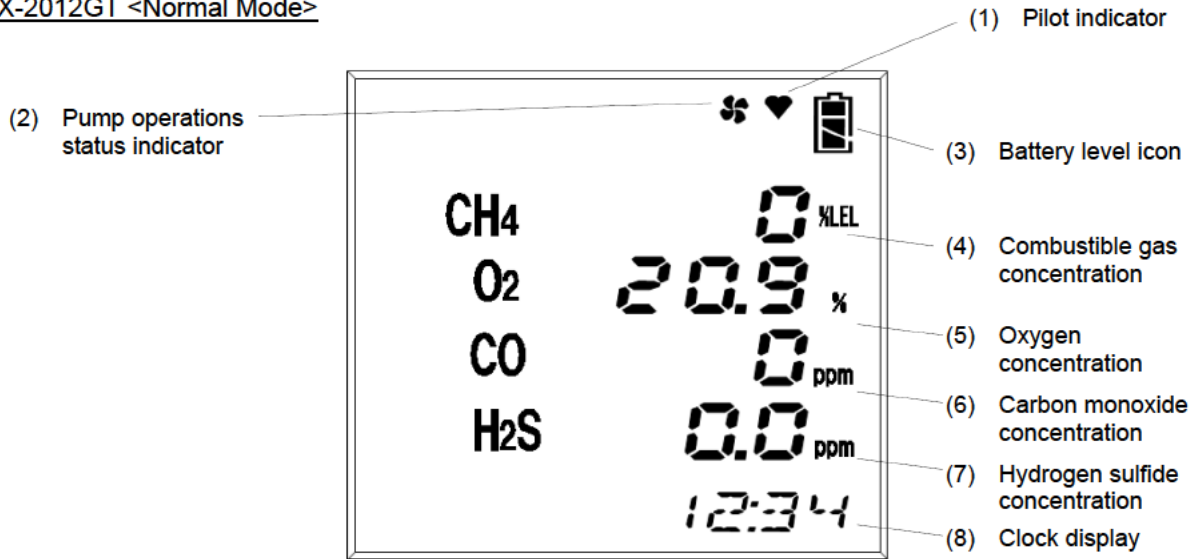

(1)	Pilot indicator	Displays the operating status. Normal: Blinking
(2)	Pump operation status indicator	Displays the drawing status. Normal: Rotating
(3)	Battery level icon	Displays the battery level. See the information below for the meanings of battery level icons.
(4)	Combustible gas concentration	Displays the gas concentration as numeric output.
(5)	Oxygen concentration	Displays the gas concentration as numeric output.
(6)	Carbon monoxide concentration	Displays the gas concentration as numeric output.
(7)	Hydrogen sulfide concentration	Displays the gas concentration as numeric output.
(8)	Clock display	Displays the current time.

**NOTE**

- The meanings of battery level icons are as follows:  
 : Sufficient / : Low / : Needs replacement (charging)
- If the battery level further drops, the inside of the battery icon starts to blink ().
- Operations are slightly different depending on the type.
- GX-2012GT does not offer a type which detects hydrogen sulfide.

<LCD Display>

GX-2012GT <Leak Check Mode>

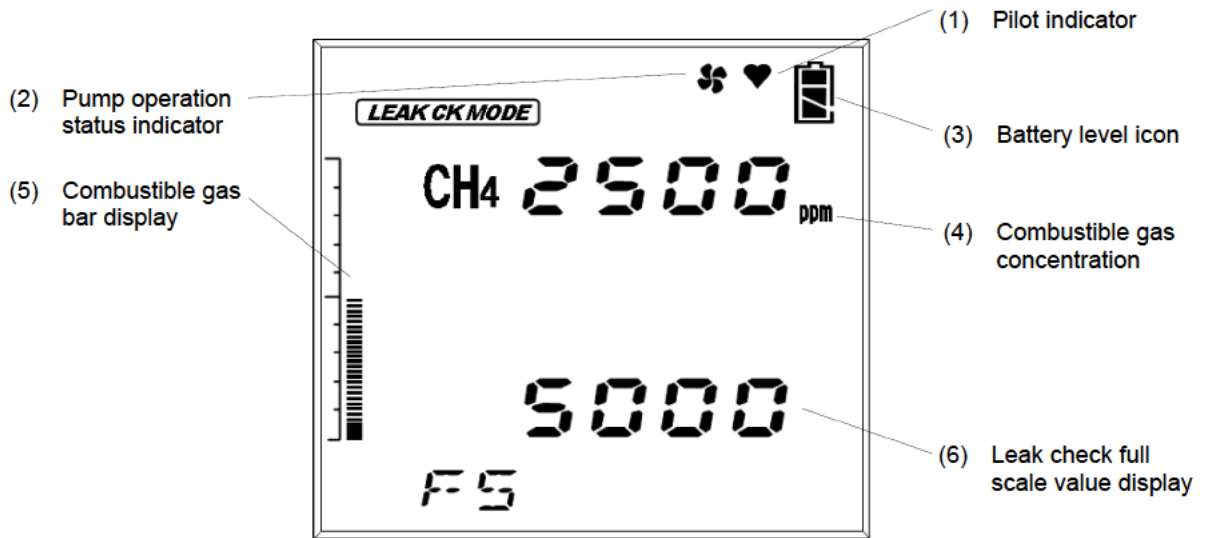

(1)	Pilot indicator	Displays the operating status. Normal: Blinking
(2)	Pump operation status indicator	Displays the drawing status. Normal: Rotating
(3)	Battery level icon	Displays the battery level. See the information below for the meanings of battery level icons.
(4)	Combustible gas concentration	Displays the gas concentration as numeric output.
(5)	Combustible gas bar display	Displays the gas concentration as a level in the bar graph.
(6)	Leak check full scale display	Displays the full scale value to be used in the leak check mode.

**NOTE**

- The meanings of battery level icons are as follows:  
 : Sufficient / : Low / : Needs replacement (charging)
- If the battery level further drops, the inside of the battery icon starts to blink ().
- Leak check full scale value can be selected from 4 levels: 500 ppm, 1000 ppm, 2000 ppm, and 5000 ppm.



---

## 4

---

# How to Use

### 4-1. Before using the gas monitor

Not only the first-time users but also the users who have already used the product must follow the operating precautions. Ignoring the precautions may damage the gas monitor, resulting in inaccurate gas detection.

### 4-2. Preparation for start-up



#### CAUTION

- The display is covered by the protective film to prevent scratches from shipping.
- Be sure to remove this film before use.
- Gas monitor with this film will not satisfy the explosion-proof performance.

Before starting gas detection, check the followings

- Check that the protective film attached on the display from shipping is removed.
- Check that the battery level is sufficient.
- Check that there is no bend or hole in the taper nozzle.
- Check that the filter in the main unit is free of dust or clogging.
- Check that the main unit and taper nozzle are connected properly.

## <Attaching Batteries>

When the gas monitor is used for the first time, or when the battery level is low, attach new AA alkaline batteries.



### DANGER

- Do not modify or change the circuit or structure, etc.
- When using this gas monitor in a hazardous area, take the following countermeasures for preventing dangers resulting from electrostatic charges.
  - (1) Wear anti-static clothes and conductive shoes (anti-static work shoes).
  - (2) For indoor use, use the gas monitor while standing on a conductive work floor (with a leakage resistance of 10 MΩ or less).
- Replace the battery unit in a non-hazardous area.
- Replace the batteries in a non-hazardous area.
- The specifications of the battery unit are as follows:  
Maximum voltage: 4.95 V, Power: LR6 (Manufactured by Toshiba, 1.5 VDC) × 3, Ambient temperature: -20 °C - 50 °C
- The main units that can be connected are GX-2012 or GX-2012GT (certificate number TC20170).



### CAUTION

- Turn off the power of the gas monitor before replacing the batteries.
- Replace all of the three batteries with new ones at one time.
- Pay attention to the polarities of the batteries.
- If the battery cover fixing lever is not completely tightened, the dry batteries may drop off or water may get in through the clearance. Water may also get in if a minute foreign substance is caught beneath the battery unit.
- Chargeable batteries cannot be used.

- (1) Turn the battery cover fixing lever counterclockwise to open the battery cover.
- (2) Paying attention to the polarities of batteries, replace all the three batteries with new ones.
- (3) Close the battery cover, turn the battery cover fixing lever clockwise to tighten the battery cover.

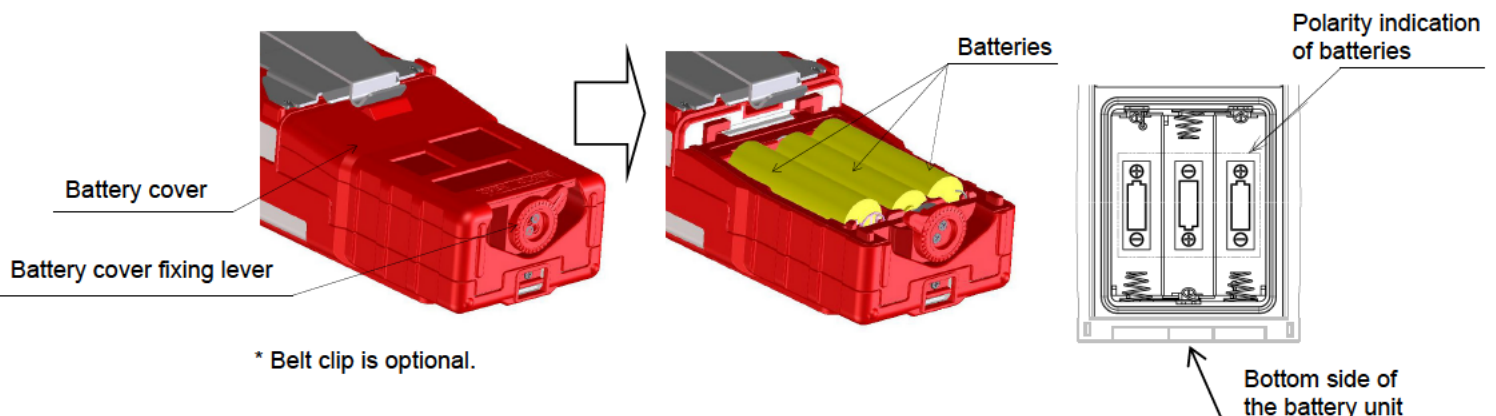

## <Charging Batteries>

(When the option unit BUL-2012, BUL-2012(G1) are used)

When the gas monitor is used for the first time, or when the battery level is low, be sure to use the dedicated charger to charge the batteries.



### DANGER

- Do not modify or change the circuit or structure, etc.
- When using this gas monitor in a hazardous area, take the following countermeasures for preventing dangers resulting from electrostatic charges.
  - (1) Wear anti-static clothes and conductive shoes (anti-static work shoes).
  - (2) For indoor use, use the gas monitor while standing on a conductive work floor (with a leakage resistance of 10 MΩ or less).
- Replace the battery unit in a non-hazardous area.
- Recharge the batteries by the dedicated charger in a non-hazardous area.
- Charge the battery unit at ambient temperatures between 0 to 40 °C.
- The specifications of the gas monitor are as follows:  
Maximum voltage: 4.95 V, Ambient temperature: -20 - +50 °C, Charging contacts: Allowable voltage 17.8 V, allowable current 2.72 A
- The main units that can be connected are GX-2012 or GX-2012GT (certificate number TC20170).



### CAUTION

- Do not use the gas monitor while charging it. Correct measurements cannot be obtained. Furthermore, the batteries get deteriorated more quickly and may have shorter life.
- The charger is neither water-proof nor dust-proof. Do not charge the batteries while the gas monitor is wet.
- The AC powered charger is not explosion-proof.

- (1) Put the DC plug of the AC adaptor into the DC jack of the charger.
- (2) Connect the AC plug of the AC adaptor into the wall electric outlet.
- (3) Insert the main unit straight along the groove of the charger.  
When charging is started, the charging indicator lamp lights up (red).  
(Charging time: Three hours at the maximum until the batteries are fully charged)
- (4) When charging is completed, the charging indicator lamp goes off.
- (5) When charging is completed, disconnect the AC plug from the wall electric outlet.

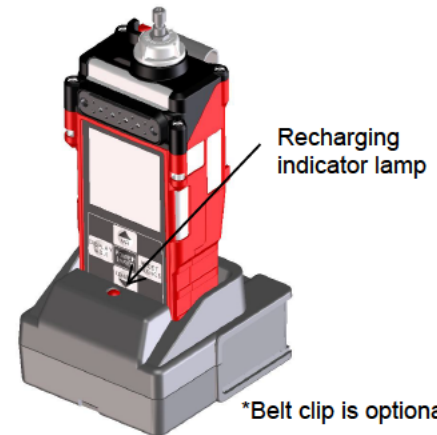

### CAUTION

- Disconnect the AC plug from the wall electric outlet while it is not in use.

### NOTE

- During recharging, the battery unit may get hot, but this is not an abnormality.
- The temperature of the gas monitor is high immediately after charging is completed. Allow at least 10 minutes or more for the unit to cool down before using it. Otherwise, correct measurements may not be obtained.
- When fully charged batteries are charged again, the charging indicator lamp does not go on.
- It is possible to charge the lithium ion battery unit alone by removing it from the main unit.

### <Releasing and Attaching the Battery Unit>



#### **DANGER**

Attach and remove the battery unit in a non-hazardous area.

- (1) Push down the battery unit release lever to unlock it.
- (2) Slide the battery unit in the direction of the arrow and remove the battery unit.
- (3) Attach a new battery unit.  
Hold the battery unit aligned with the guide and slide the unit until it clicks.
- (4) Make sure that the battery unit is locked.

Battery unit release lever

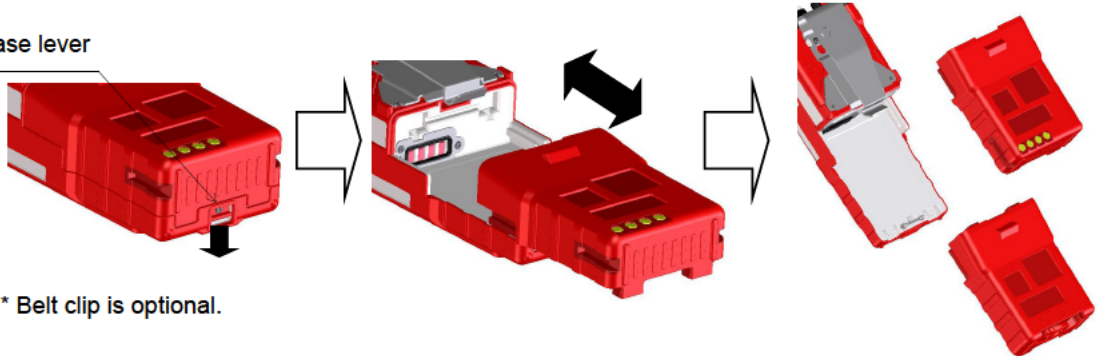

#### **CAUTION**

- Turn off the power of the gas monitor before replacing the battery unit.
- If the battery unit release lever is not completely locked, the battery unit may drop off or water may get in through the clearance. Water may also get in if a minute foreign substance is caught beneath the battery unit.
- Do not damage the rubber seal.
- To maintain the water-proof and dust-proof performances, it is recommended to replace the rubber seal every two years, whether or not it has an abnormality.

### <Connecting Taper Nozzle>

- Connect the taper nozzle to the gas inlet of the gas monitor.

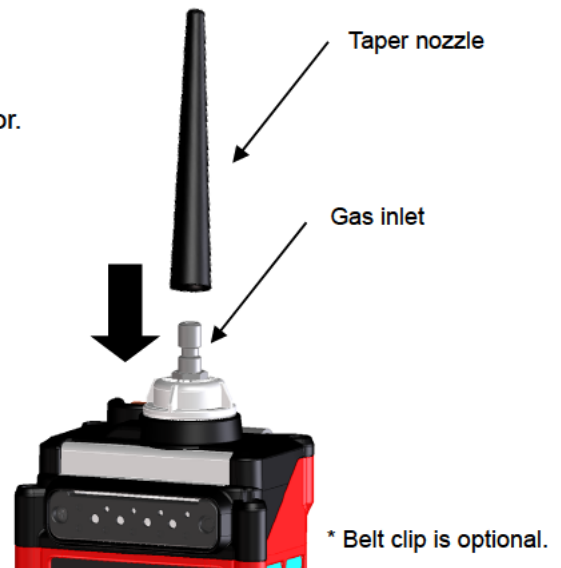

#### **CAUTION**

Use only the parts specified by RIKEN KEIKI on this gas monitor.

## 4-3. Basic operating procedures

<GX-2012>

Normally, the detection mode is used for normal operations. (The detection mode is activated after the power is turned on.) (\* Operations are slightly different depending on the type)

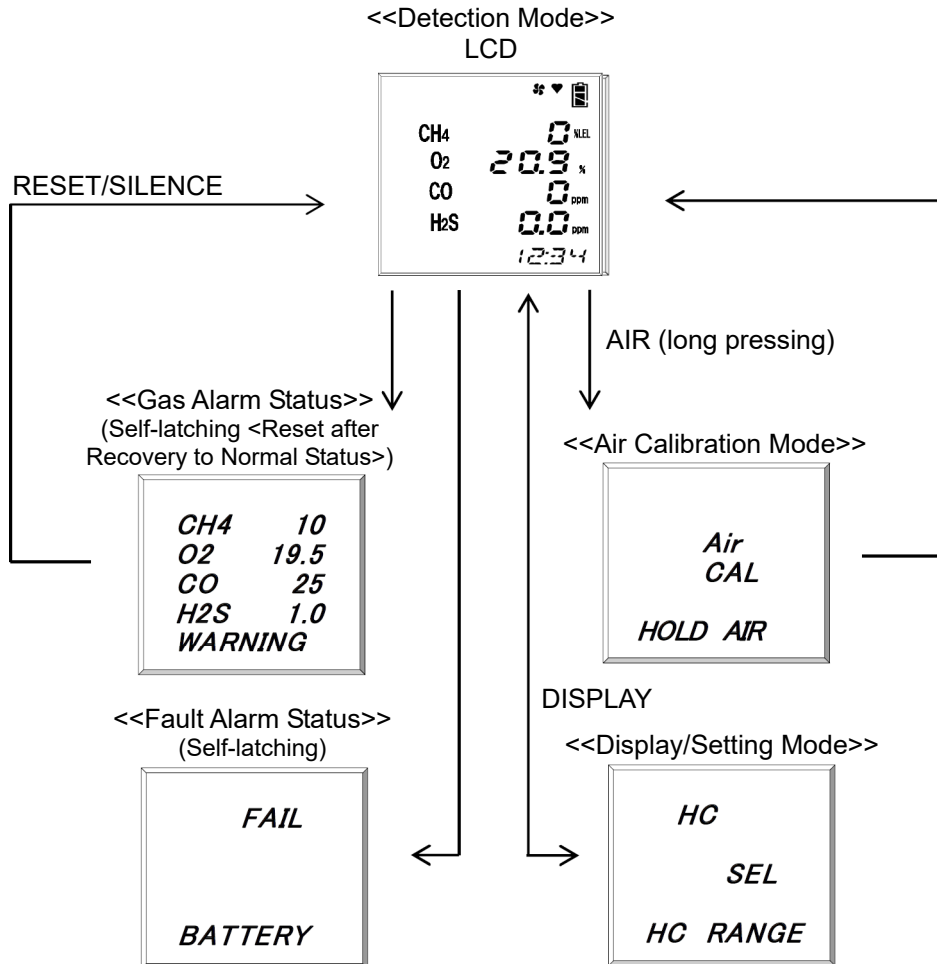

<GX-2012GT>

Normally, after the power is turned on, the detection mode (normal mode or leak check mode) is selected for use.

(\* Operations are slightly different depending on the type)

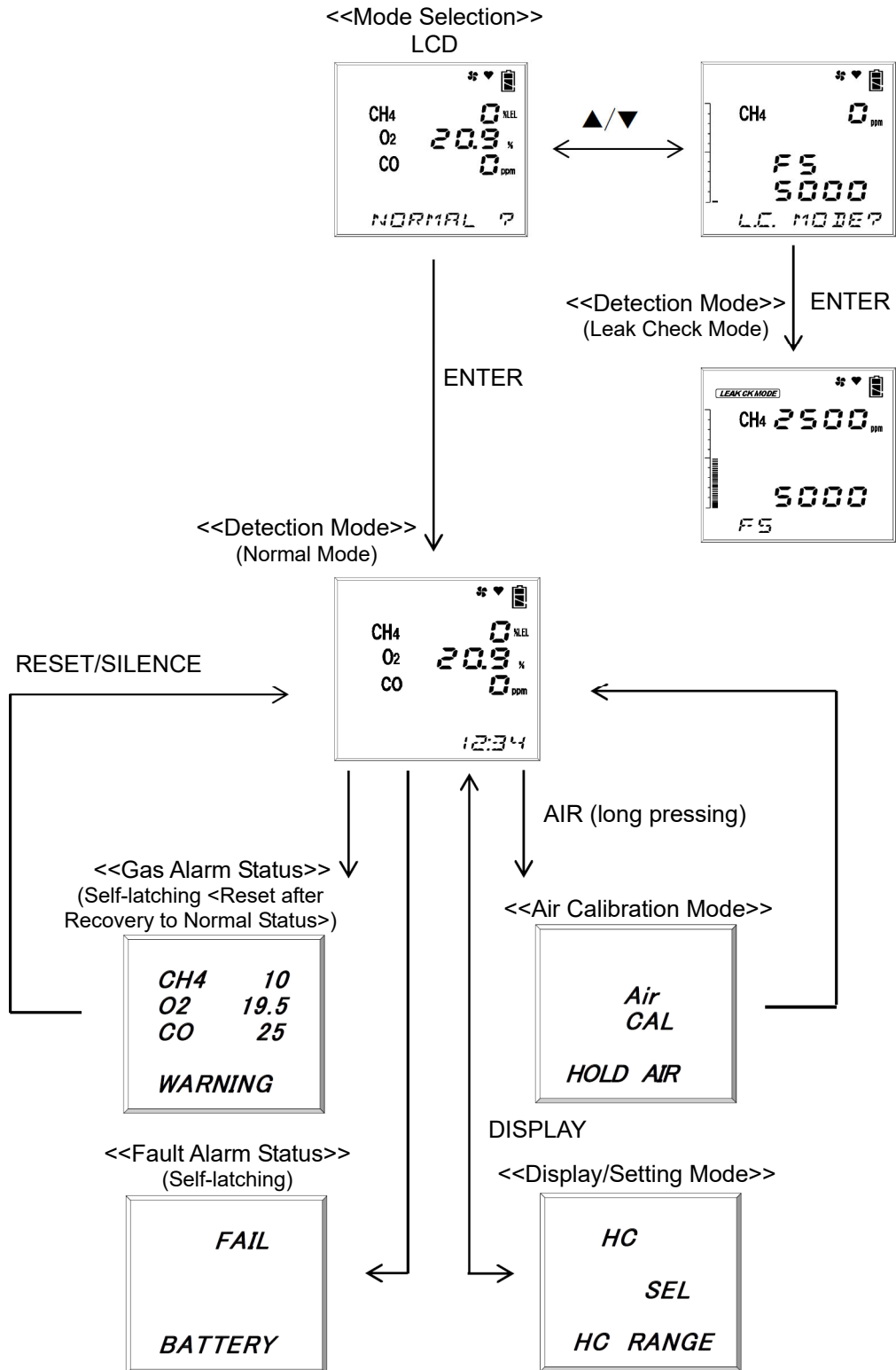

# 4-4. How to start the gas monitor

<<GX-2012 Start-up Procedure>> (\* Operations are slightly different depending on the type)

Keep the POWER switch pressed for three seconds or more.



All LCDs light up.  
Alarm lamp lights up.  
Buzzer sounds once (Beep).

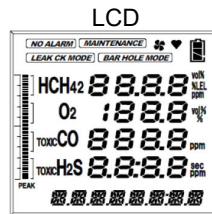

Date/Time Display  
Example: October 1<sup>st</sup>, 2012 12:00

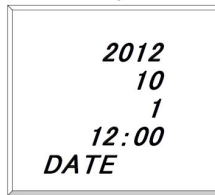

Battery voltage display  
Example: Voltage 3.3 V

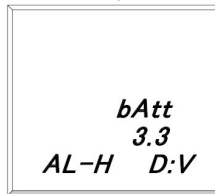

- \* Gas alarm activation  
AL-A: Auto-reset  
AL-H: Self-latching
- \* Types of battery unit  
D: Dry battery unit  
(No display): Lithium ion battery unit

Gas name display  
Example: Gas to be detected CH<sub>4</sub>, O<sub>2</sub>, CO, H<sub>2</sub>S  
CH<sub>4</sub> Detection range vol%, %LEL

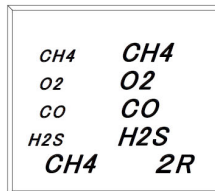

Full Scale Display  
Example: CH<sub>4</sub> 100 %LEL, 100 vol%  
O<sub>2</sub> 40.0 %  
CO 500 ppm  
H<sub>2</sub>S 30.0 ppm

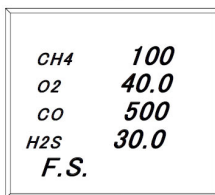

First Alarm Setpoint Display  
Example: CH<sub>4</sub> 10 %LEL  
O<sub>2</sub> 19.5 %  
CO 25 ppm  
H<sub>2</sub>S 1.0 ppm

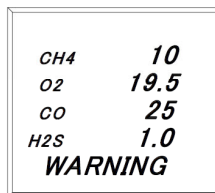

Second Alarm Setpoint Display  
Example: CH<sub>4</sub> 50 %LEL  
O<sub>2</sub> 18.0 %  
CO 50 ppm  
H<sub>2</sub>S 10.0 ppm

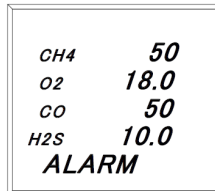

**STEL Alarm Setpoint Display**

Example: CO 200 ppm  
H<sub>2</sub>S 5.0 ppm

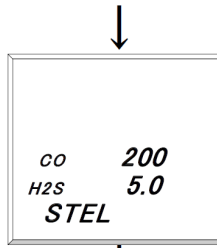

**TWA Alarm Setpoint Display**

Example: CO 25 ppm  
H<sub>2</sub>S 1.0 ppm

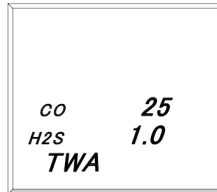

**Detection Mode**

Buzzer sounds twice (Beep, beep).

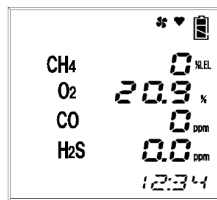

**CAUTION**

After start-up, perform air calibration before performing gas detection. (See '4-7. Air calibration mode')

**NOTE**

- A sensor abnormality alarm is issued before the detection mode is entered if there is any abnormality in the sensor. Press the RESET switch. This will reset the sensor abnormality alarm temporarily, set the gas concentration display that was abnormal on the sensor to [---], and start gas detection. However, notify the abnormality to RIKEN KEIKI promptly. Gas for which there was an abnormality in the sensor cannot be detected. However, the alarm cannot be reset if there is an abnormality in all the sensors.
- If there is an abnormality in the built-in clock, a fault alarm [FAIL CLOCK] may be issued. Press the RESET switch. The fault alarm is temporarily reset, and measurement is started with incorrect clock time.



<<GX-2012GT Start-up Procedure>> (\* Operations are slightly different depending on the type)

Press the POWER switch for at least 3 seconds.



All LCDs light up.  
Alarm lamp lights up.  
Buzzer sounds once (Beep).

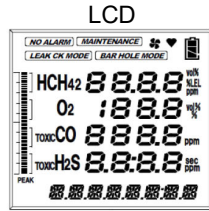

<<Normal Mode>>

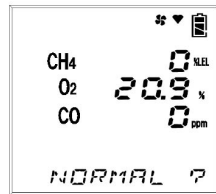

ENTER

Mode Selection

<<Leak Check Mode>>

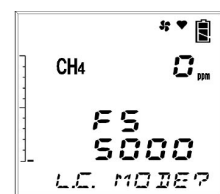

ENTER

Date/Time Display  
Example: October 1<sup>st</sup>,  
2012 12:00

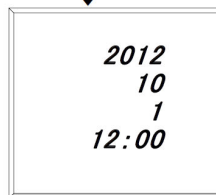

Date/Time Display  
Example: October 1<sup>st</sup>,  
2012 12:00

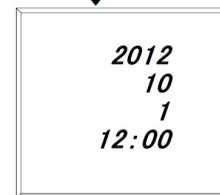

Battery voltage display  
Example: Voltage 3.3 V

\* Gas alarm activation  
AL-A: Auto-reset  
AL-H: Self-latching  
\* Types of battery unit  
D: Dry battery unit  
(No display): Lithium ion battery unit

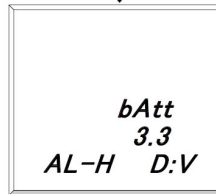

Battery voltage display  
Example: Voltage 3.3 V

\* Gas alarm activation  
AL-A: Auto-reset  
AL-H: Self-latching  
\* Types of battery unit  
D: Dry battery unit  
(No display): Lithium ion battery unit

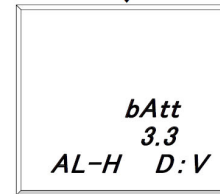

Gas name display

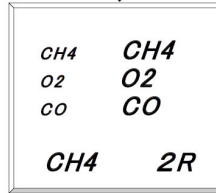

Gas name display

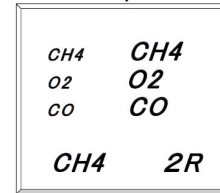

Full Scale Display  
Example: CH<sub>4</sub> 100 %LEL,  
100 vol%,  
O<sub>2</sub> 40.0 %  
CO 500 ppm

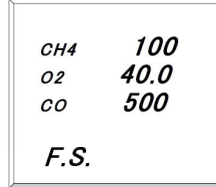

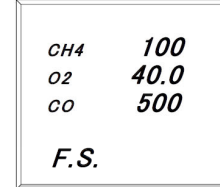

Full Scale Display  
Example: CH<sub>4</sub> 100 %LEL,  
100 vol%,  
O<sub>2</sub> 40.0 %  
CO 500 ppm

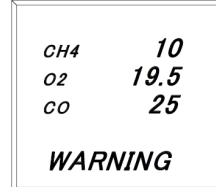

First Alarm Setpoint Display  
Example: CH<sub>4</sub> 10 %LEL  
O<sub>2</sub> 19.5 %  
CO 25 ppm

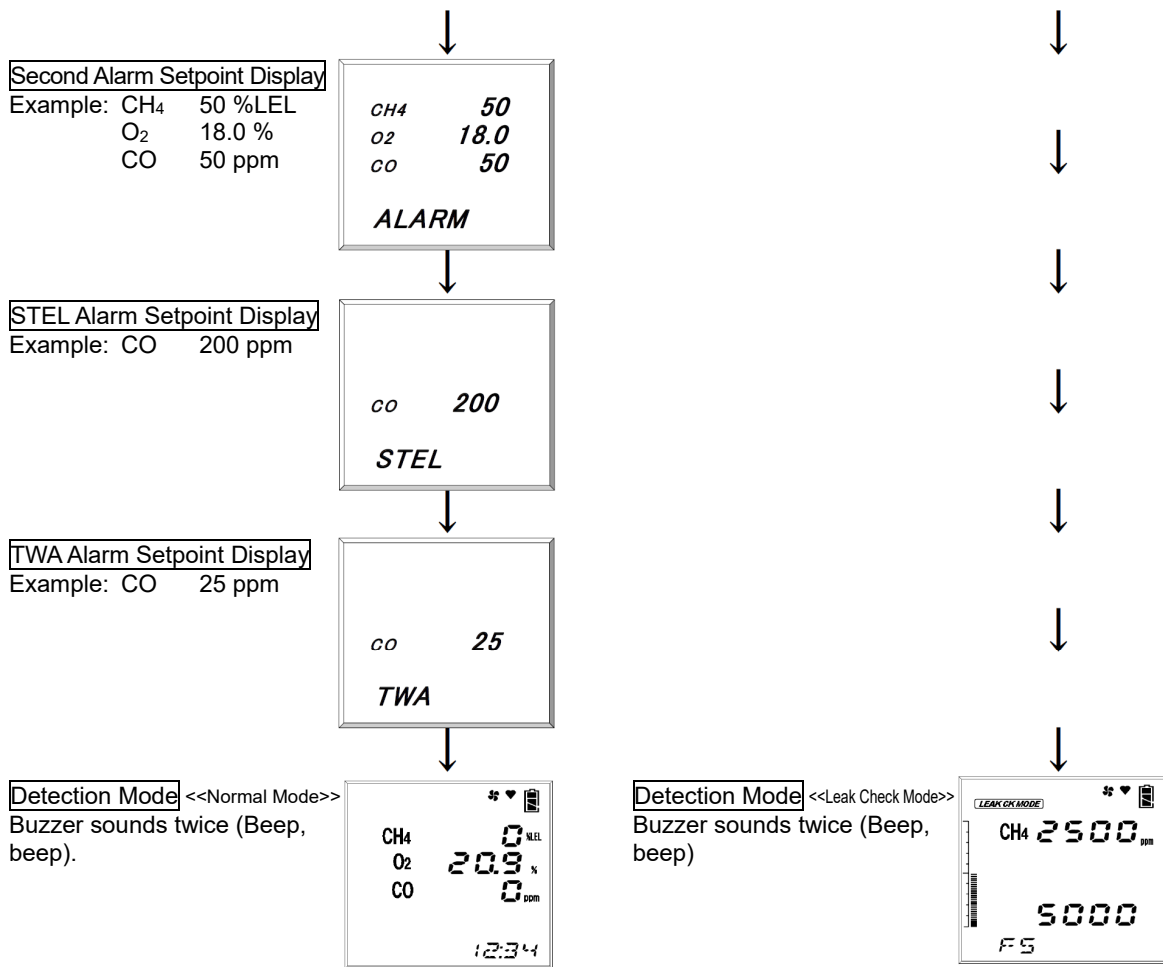



 **CAUTION**  
 After start-up, perform air calibration before performing gas detection. (See '4-7. Air calibration mode')

**NOTE**

- A sensor abnormality alarm is issued before the detection mode is entered if there is any abnormality in the sensor. Press the RESET switch. This will reset the sensor abnormality alarm temporarily, set the gas concentration display that was abnormal on the sensor to [---], and start gas detection. However, notify the abnormality to RIKEN KEIKI promptly. Gas for which there was an abnormality in the sensor cannot be detected. However, the alarm cannot be reset if there is an abnormality in all the sensors.
- If there is an abnormality in the built-in clock, a fault alarm [FAIL CLOCK] may be issued. Press the RESET switch. The fault alarm is temporarily reset, and measurement is started with incorrect clock time.

## 4-5. How to detect

In each mode, put the taper nozzle close to the detection area and take the reading on the display.  
(\* Operations are slightly different depending on the type)

GX-2012

GX-2012GT <Normal Mode>

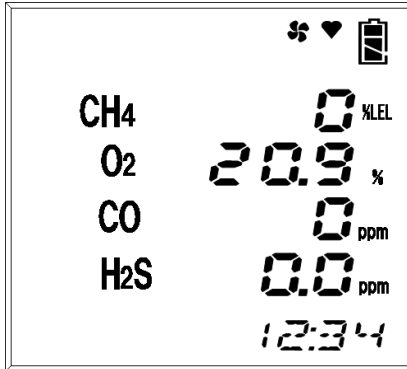

← Display example

CH<sub>4</sub> concentration: 0 %LEL  
O<sub>2</sub> concentration: 20.9 %  
CO concentration: 0 ppm  
H<sub>2</sub>S concentration: 0.0 ppm  
Time: 12:34  
Battery level: Sufficient

GX-2012GT <Leak Check Mode>

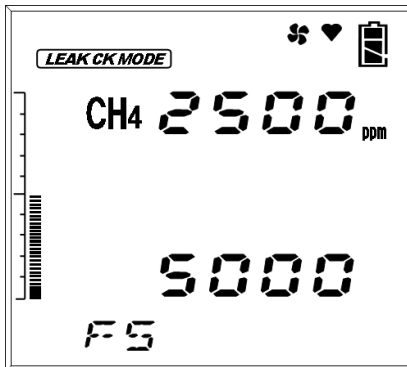

← Display example

CH<sub>4</sub> concentration: 2500 ppm  
Battery level: Sufficient



### DANGER

- While conducting measurement in a manhole or confined space, do not lean over or look into the manhole or closed space. It may lead to dangers because oxygen-deficient air or other gases may blow out.
- Oxygen-deficient air or other gases may blow out from the gas exhausting outlet. Never inhale the air or gases.
- High-concentration (100 %LEL or higher) gases may be discharged. Never use fire near the gas monitor.



## WARNING

- The gas monitor is designed to draw gases around it under the atmospheric pressure. If excessive pressure is applied to the gas inlet and outlet (GAS IN, GAS OUT) of the gas monitor, detected gases may leak out from its inside and may cause dangerous conditions. Avoid applying excessive pressure to the gas monitor while in use.
- Do not connect the taper nozzle directly to a location with a pressure higher than the atmospheric pressure. The internal piping system may be damaged.
- When the fresh air adjustment is performed in the atmosphere, check the atmosphere for freshness before beginning the adjustment. If other gases exist, the adjustment cannot be performed properly, thus leading to dangers when the gas leaks.
- Issuance of a gas alarm indicates that there are extreme dangers. Take proper actions based on your judgment.
- Before use, check that there remains sufficient battery power. When the gas monitor is used for the first time or is not used for a long period, the batteries may be exhausted. Either fully charge the batteries or replace them with new ones before use.
- If a low battery alarm is triggered, gas detection cannot be conducted. If the alarm is triggered during use, turn off the power and promptly charge the batteries in a non-hazardous area.
- Do not block the buzzer sound opening. No alarm sound can be heard.



## CAUTION

- When you measure concentrations of oxygen in inert gases for a long time, the carbon dioxide concentration in the air must be 15 % or less. When you use the gas monitor in the inert gas with a carbon dioxide concentration of 15 % or higher, perform measurement in as short time as possible. Using the gas monitor under high concentrations for a long time may shorten the life of the oxygen sensor.
- An oxygen concentration higher than a certain level is required for the combustible gas %LEL sensor of the gas monitor to correctly detect gases and display concentrations.
- During combustible gas detection (%LEL range), long-time detection of a high-concentration combustible gas may adversely influence the sensor.

## NOTE

- If the combustible gas reading exceeds 100 %LEL, the CO reading rises temporarily but this is not abnormal.
- In a low-temperature environment, the operating time is shortened due to the battery performance property.
- At a low temperature, the response of the LCD display may get slow down.
- If a combustible gas with a higher concentration than 100 %LEL is drawn, some gas may remain in the taper nozzle and filter due to adsorption. After drawing a high-concentration combustible gas, clean the gas monitor to remove the adsorbed gas (draw fresh air and check that the reading becomes zero). Performing fresh air adjustment before cleaning it completely will result in inaccurate adjustment, giving adverse influence on measurement.
- Perform gas detection in the vol% range in a place where the presence of a high-concentration combustible gas is known. (\*Only with the types which detect high-concentration combustible gas <vol%>)

### <Leak Check Mode>(GX-2012GT <Leak Check Mode>)

Depending on the concentration of combustible gas, bar display is increased or decreased and the buzzer sounds intermittent beeps. As the concentration becomes higher, the interval of intermittent beeps of the buzzer becomes shorter.

The basic screen transition in the leak check mode is as follows:

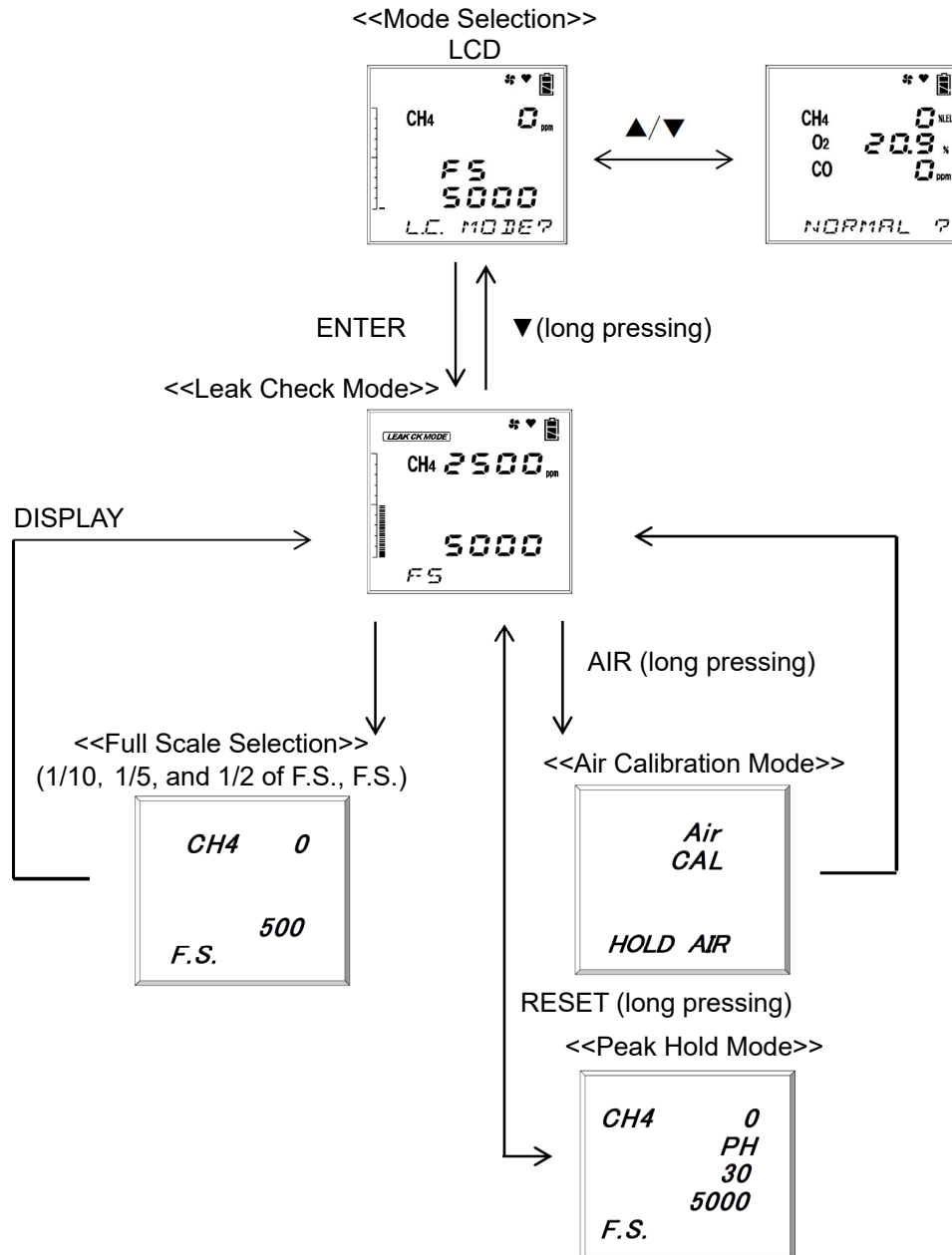

**NOTE**

- The full scale of the leak check can be selected. Every time the DISPLAY switch is pressed, the full scale changes between 4 levels: 500 ppm, 1000 ppm, 2000 ppm, and 5000 ppm.
- If the detection result exceeds the full scale, the range changes automatically to LEL and VOL%.
- The peak of the leak value can be held. Press the RESET switch long (See the figure on the right).
- The peak value can be cleared by pressing the RESET switch (for about 1 second).
- Keep the DISPLAY switch pressed long to turn off the intermittent beeps of the buzzer at the time of leak check. At this time, [NO ALARM] will be displayed.

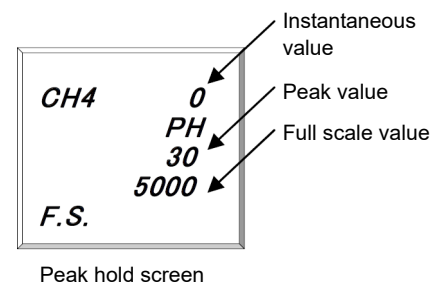

## <Manual Memory> (GX-2012, GX-2012GT <Normal Mode>)

Any instantaneous value during measurement can be recorded.

Up to 256 points of data can be recorded. When the number of recorded data points reaches the maximum, recorded data will be overwritten, starting from the oldest data.

- (1) In the detection mode, press the ▲ switch while the ▼ switch is pressed to prepare the recording. (For about one second). The following screens are displayed in turn on the gas monitor.

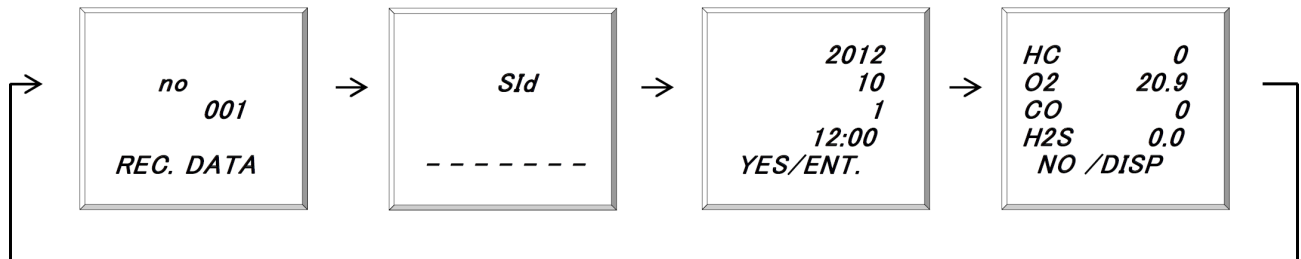

### NOTE

The screen displays the memory number, date, and instantaneous value in turn. Go to the next step to execute recording. No value is recorded at this point yet. If you do not want to record a value, press the DISPLAY switch to return to the detection mode.

- (2) Press the ENTER switch. The date and the instantaneous value at the time when the ENTER switch is pressed are recorded.
- (3) When [SAVED] is displayed and the state returns to (1), the recording is completed.



- (4) To continue recording, repeat steps (1) to (3).  
To exit the manual memory, press the DISPLAY switch and return to the detection mode.

### <About Auto Range Switching Point>

(GX-2012 TYPE-A, E, GX-2012GT <Normal Mode>(\*Only the types which detect high-concentration combustible gases <vol%>)

If Auto Range is set on a type with the vol% range for combustible gases, the display is automatically switched to the vol% range when the concentration of a detected combustible gas exceeds 100 %LEL. When the concentration drops, the display returns to the %LEL range again. The following shows an example of switching timing.

Diagram of gas concentrations and range switching timing under Auto Range setting

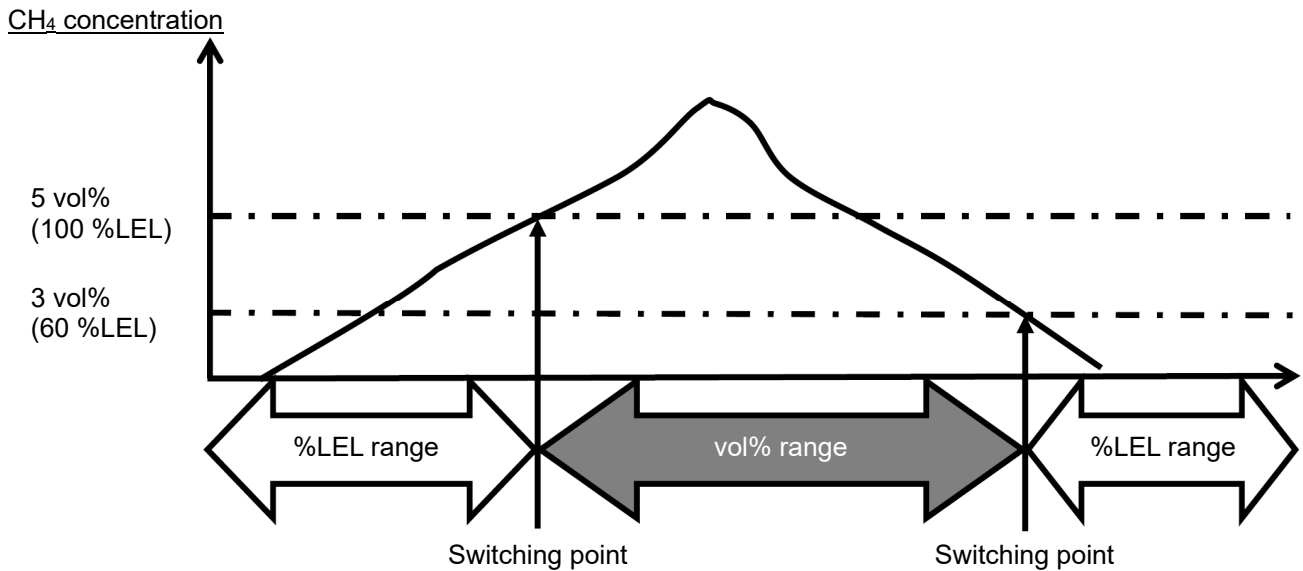





#### CAUTION

An oxygen concentration higher than a certain level is required for the combustible gas %LEL sensor of the gas monitor to correctly detect gases and display concentrations. For the sake of more accurate gas detection and concentration display, therefore, this gas sensor may perform detection using the vol% sensor if the built-in oxygen sensor of this gas monitor detects an oxygen concentration lower than a certain level in the atmosphere.

In other words, the display changes at the timing shown above when the oxygen concentration is equal to or higher than a certain level. If it is lower than a certain level, however, the vol% sensor is used for detection even if the combustible gas concentration is lower than the switching point.

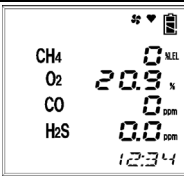
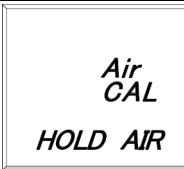
## 4-6. Modes (GX-2012, GX-2012GT <Normal Mode>)

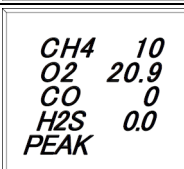
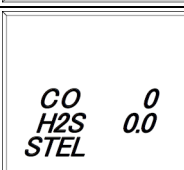
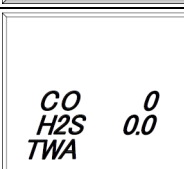
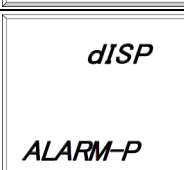
Details on each mode are provided as follows. (\* Operations are slightly different depending on the type)

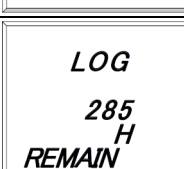
Mode	Item	LCD display	Details	
Detection Mode	-	Display		Normal state.
Air Calibration Mode	-	[Air CAL]		Perform the zero adjustment.
Display/Setting Mode	Combustible Gas Measurement Range Setting	[HC RANGE]		Used to select a combustible gas measurement range manually.
	Peak display	[PEAK]		Displays the maximum concentration (or minimum concentration for oxygen) detected during measurement from power-on to the present.
	STEL Value Display	[STEL]		Displays the STEL value after power-on.
	TWA Value Display	[TWA]		Displays the TWA value after power-on.
	Full Scale/ Alarm Setpoint Display/ Alarm Test	[ALARM-P]		Displays the full scale and alarm setpoint values and performs the alarm test for the settings displayed.
	Operation Time Display	[OP.TIME]		Displays the operation time.
	Date/Time Display	[DATE]		Displays the time based on the built-in clock.
	Data Logger Remaining Time Display	[REMAIN]		Displays the remaining time which data logger can record.



Mode	Item	LCD display	Details	
Display/Setting Mode	Clear Log Data	[LG CLEAR]	<div style="border: 1px solid black; padding: 5px; text-align: center;"> <b>CLr</b>  <b>LOG</b>  <b>LG CLEAR</b> </div>	Clears the log data.
	User ID Display/ Selection	[UId SEL]	<div style="border: 1px solid black; padding: 5px; text-align: center;"> <b>UId</b>  <b>SEL</b>            -----         </div>	Displays and selects the ID. Displays an ID if it has been set in advance. Default setting is [----].
	Station ID Display/ Selection	[SID SEL]	<div style="border: 1px solid black; padding: 5px; text-align: center;"> <b>SId</b>  <b>SEL</b>            -----         </div>	Displays and selects the ID. Displays an ID if it has been set in advance. Default setting is [----].
	SnapLog Data Display	[REC.DATA]	<div style="border: 1px solid black; padding: 5px; text-align: center;"> <b>dISP</b>    <b>REC. DATA</b> </div>	Displays data recorded in the manual memory.
	Peak Display ON/OFF Setting	[bAr SEL]	<div style="border: 1px solid black; padding: 5px; text-align: center;"> <b>bAr</b>  <b>SEL</b>  <b>BAR OFF</b> </div>	Selects ON (display)/OFF (hide) of the peak display in the bar graph.

## 4-7. Air calibration mode

(GX-2012, GX-2012GT) (\* Operations are slightly different depending on the type)

Press the AIR switch.

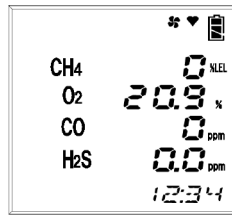

When the AIR switch is pressed, the display changes to [Adj HOLD AIR].

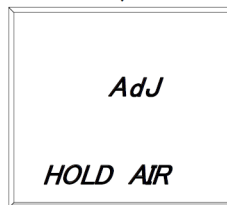
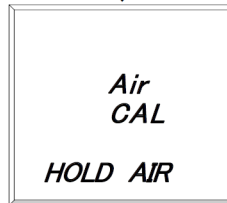

When [RELEASE] is displayed, release the AIR switch. The countdown is started (\*only with the types which detect high-concentration combustible gas <vol%>).

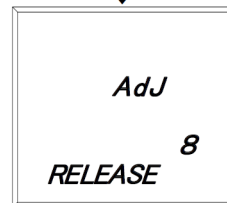

When the zero adjustment is successfully completed, it returns to the detection mode.

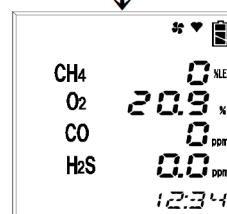

### WARNING

When air calibration is performed in the atmosphere, check the atmosphere for freshness before beginning the calibration. If other gases exist, the adjustment cannot be performed properly, thus leading to dangers when the gas leaks.



### CAUTION

- Perform air calibration under pressure and temperature/humidity conditions close to those in the operating environment and in fresh air.
- Perform air calibration after the reading is stabilized.
- If there is a sudden temperature change of 15 °C or more between the storage and operation locations, turn on the power of the gas monitor, leave the unit for about 10 minutes in a similar environment to the operation location, and perform air calibration in fresh air before using it.

**NOTE**

- Air calibration can be performed even when there is a gas alarm.
- If the air calibration fails, it displays [FAIL AIR CAL] and which sensor has become faulty. Press the RESET switch to reset the fault alarm (calibration failure). When the alarm is reset, the value before calibration is displayed. (The example on the right indicates the case of air calibration failure with CH<sub>4</sub> sensor.)



*CH4 FAIL*

*AIR CAL*

## 4-8. Display/setting mode (GX-2012, GX-2012GT <Normal Mode>)

This mode allows you to change various displays and settings.

Every time the DISPLAY switch is pressed, various screens are displayed in turn. (\* Operations are slightly different depending on the type)

**Detection Mode**

Press the DISPLAY switch.

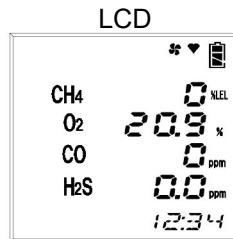

**Display/Setting Mode**

**Combustible Gas Measurement Range Setting**

Used to select a combustible gas measurement range manually.

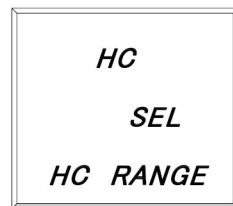

→  
 ENTER

Combustible Gas Measurement Range Setting

⇒ P36

**PEAK Value Display**

Displays the maximum concentration (or minimum concentration for oxygen) detected during measurement from power-on to the present.

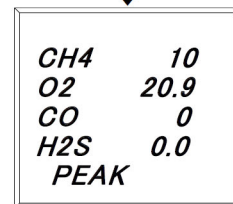

**STEL Value Display**

Displays the STEL value after power-on.

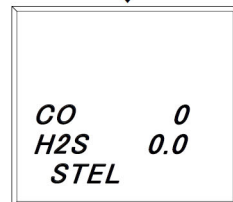

**TWA Value Display**

Displays the TWA value after power-on.

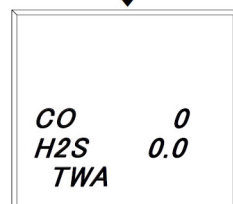

**Full Scale Display/Alarm Setpoint Display/Alarm Test**

Displays the full scale and alarm setpoint values and performs the alarm test for the settings displayed.

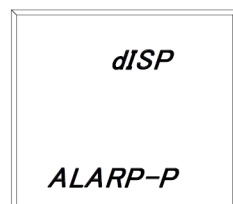

→  
 ENTER

Full Scale Display/Alarm Setpoint Display/Alarm Test

⇒ P38



**Operation Time Display**  
Displays the operation time.

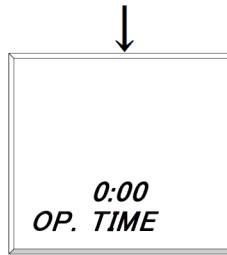

**Date/Time Display**  
Displays the time based on the built-in clock.



**Data Logger Remaining Time Display**  
Displays the remaining time which data logger can record.

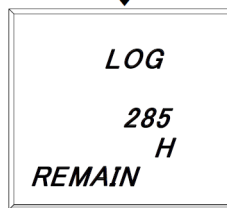

**Clear Log Data**  
Clears the log data.

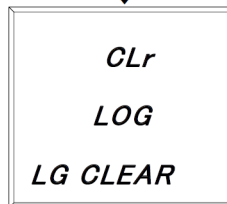

→ Clear Log Data  
ENTER ⇒ P39

**User ID Display/Selection**  
Displays and selects the ID.

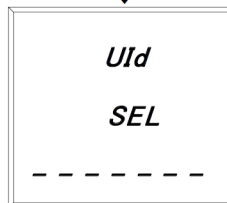

→ UID Display/Selection  
ENTER ⇒ P40

**Station ID Display/Selection**  
Displays and selects the ID.

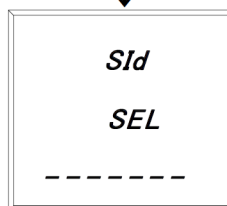

→ SID Display/Selection  
ENTER ⇒ P40

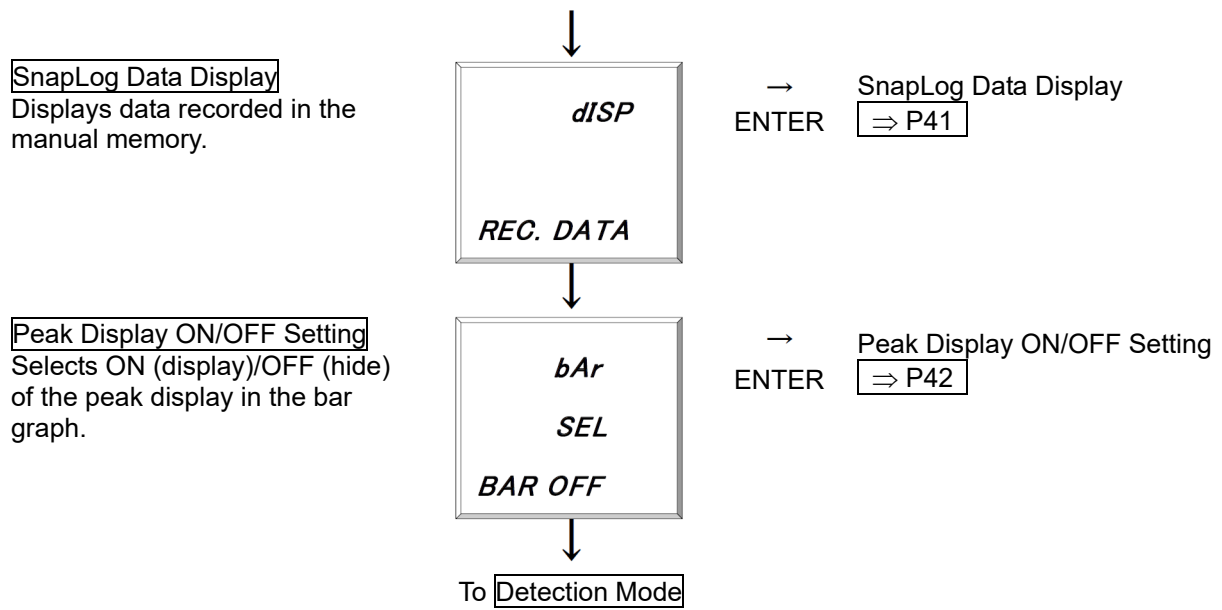
**NOTE**

The gas monitor automatically returns to the detection mode in about 20 seconds if the gas monitor is left unoperated.

### <Combustible Gas Measurement Range Setting [HC RANGE]>

(GX-2012, GX-2012GT <Normal Mode>(\*Only the types which detect high-concentration combustible gases <vol%>)

The type which can display combustible gas levels in two ways, "%LEL range" and "vol% range," automatically switch between these two displays according to the gas concentration or oxygen concentration, from "%LEL range" to "vol% range" and vice versa.

- (1) Press the DISPLAY switch and select the combustible gas measurement range setting from the display/setting mode menu.  
The following screens are displayed in turn on the gas monitor.



- (2) Press the ENTER switch.

#### NOTE

If you do not want to make a change, press the DISPLAY switch to return to the display/setting mode menu.

- (3) Every time the ▲ or ▼ switch is pressed, the measurement range menus, [AUTO RANGE] (automatic switching) and [ONLY VOL] (fixed to the vol% range) are displayed in turn.  
Press the ▲ or ▼ switch to select a measurement range and press the ENTER switch.

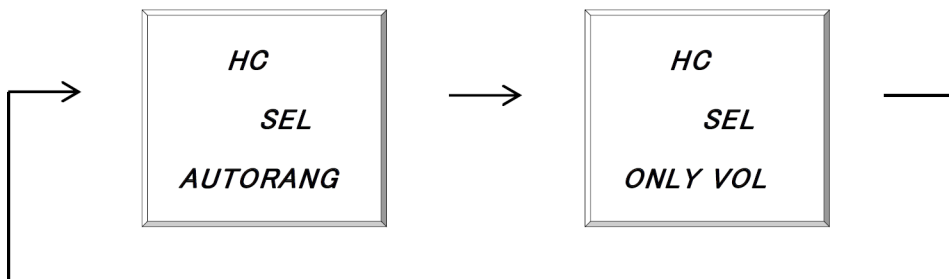

- (4) When [END] is displayed, the setting is completed.

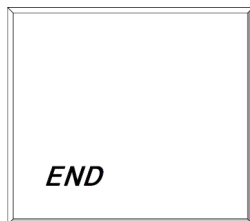

The display/setting mode menu is displayed again.

- (5) After completion, press the DISPLAY switch several times until it returns to the detection mode.

**CAUTION**

- No gas alarm is triggered in the combustible gas vol% range-only setting. In the vol% range-only setting, the screen displays [NO ALARM] because no alarm is triggered.

[NO ALARM] display

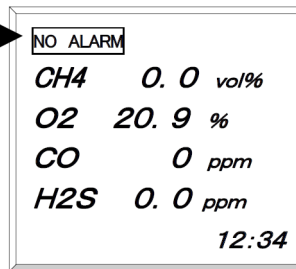

vol% range only

**NOTE**

During vol% range-only measurement, [vol%] and [NO ALARM] displays blink.



### <Full Scale Display/Alarm Setpoint Display/Alarm Test [ALARM-P]>

(GX-2012, GX-2012GT <Normal Mode>)(\*Operations are slightly different depending on the type)

Displays the full scale or alarm setpoint values and performs the alarm test for the settings displayed.

- Press the DISPLAY switch and select the full scale display / alarm setpoint display / alarm test from the display/setting mode menu. The following screens are displayed in turn on the gas monitor.

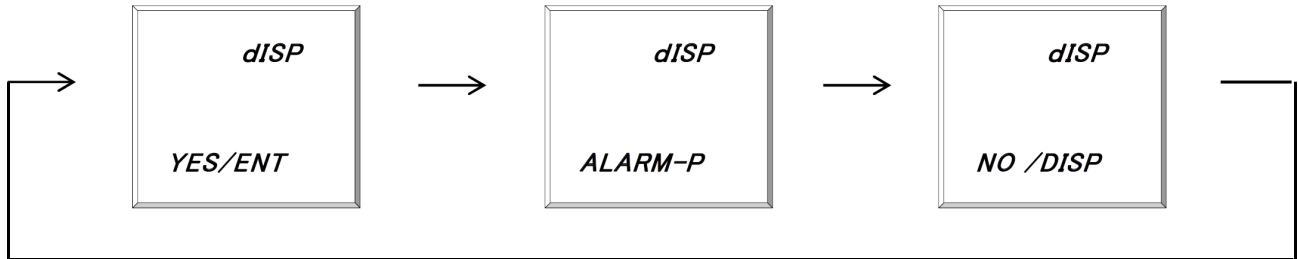

- Press the ENTER switch to enter the alarm setpoint or other display.

#### NOTE

If you do not want to enter any display, press the DISPLAY switch to return to the display/setting mode menu.

- Every time the ▲ or ▼ switch is pressed, the full scale and alarm setpoint menus, i.e. full scale display, first alarm setpoint display, second alarm setpoint display, STEL alarm setpoint display, and TWA alarm setpoint display, are displayed in turn. Press either the ▲ or ▼ switch to select a setting that you want to check.

Select one of the following screens:

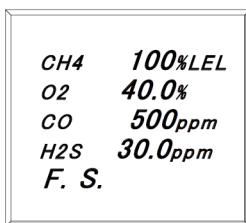

Full Scale Display

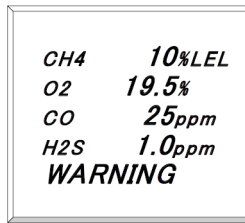

First Alarm Setpoint Display (WARNING)

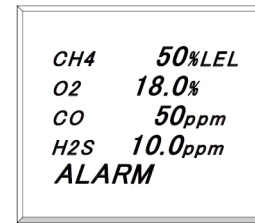

Second Alarm Setpoint Display (ALARM)

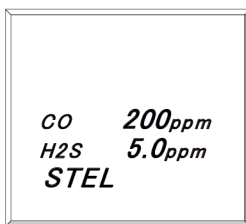

STEL Alarm Setpoint Display

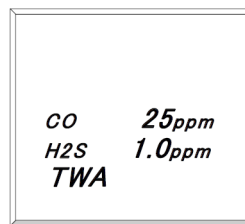

TWA Alarm Setpoint Display

- Press the ENTER switch to perform alarm test. The alarm operation on this screen can be checked. Press any switch to stop the alarm operation.
- Press the DISPLAY switch to exit the alarm setpoint display or alarm test. The display/setting mode menu is displayed again.
- After completion, press the DISPLAY switch to return to the detection mode.

### <Clear Log Data [LG CLEAR]> (GX-2012, GX-2012GT <Normal Mode>)

Clears the log data which was recorded.

- (1) Press the DISPLAY switch and select the Clear Log Data from the display/setting mode menu. The following screens are displayed in turn on the gas monitor.



- (2) Press the ENTER switch. The following screens are displayed in turn on the gas monitor.

#### NOTE

If you do not want to clear the log data, press the DISPLAY switch to return to the display/setting mode menu.

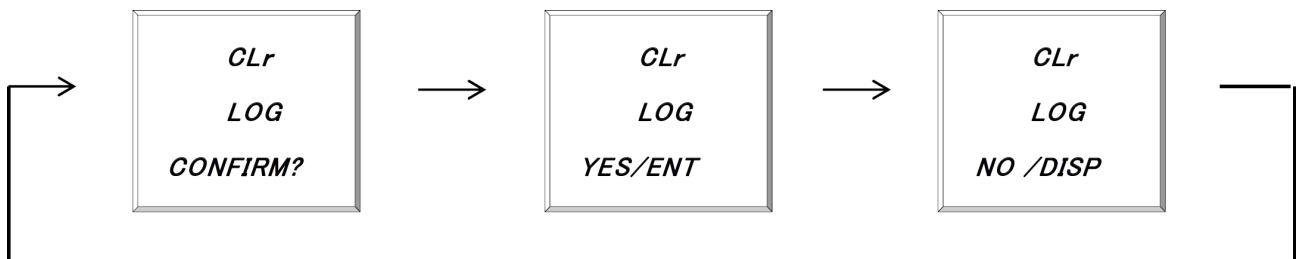

- (3) Press the ENTER switch. When [----] display disappears and [END] is displayed, the clear procedure is completed.

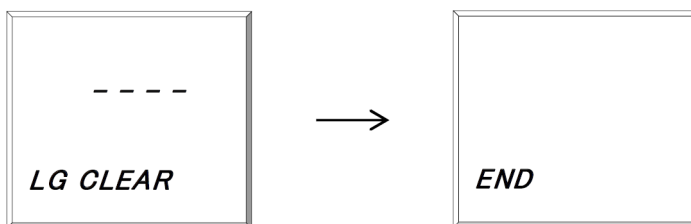

- (4) Press the DISPLAY switch to return to the display/setting mode menu.  
 (5) After completion, press the DISPLAY switch several times until it returns to the detection mode.

<User ID Display/Select [UID SEL]> (GX-2012, GX-2012GT <Normal Mode>)

<Station ID Display/Select [SID SEL]> (GX-2012, GX-2012GT <Normal Mode>)

Displays and selects the UID (User ID) and the SID (Station ID).

- (1) Press the DISPLAY switch and select the ID display/selection from the display/setting mode menu. The following screens are displayed in turn on the gas monitor. (The figure below is the example of User ID display/selection.)

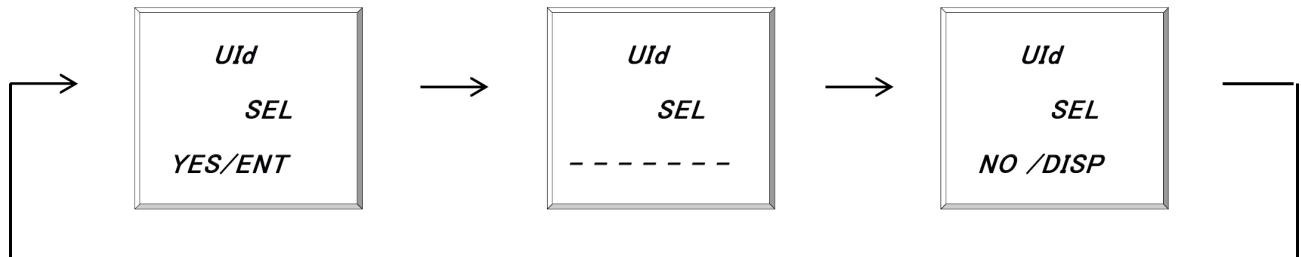

- (2) Press the ENTER switch to set or select an ID.

### NOTE

- If you do not want to set or select an ID, press the DISPLAY switch to return to the display/setting mode menu.
- When the gas monitor is used for the first time, the ID display indicates [----].
- Unless otherwise specified, IDs of USER-001 to USER-128 (User ID) and 001 to 128 (station ID) are registered.
- The data logger management program (option) is required to register or change an ID. Please contact RIKEN KEIKI.

- (3) Press either the ▲ or ▼ switch to select an ID. Every time the ▲ or ▼ switch is pressed, the ID number changes.

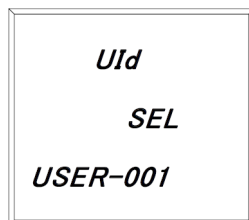

- (4) Press the ENTER switch. When [END] is displayed, the setting is completed.

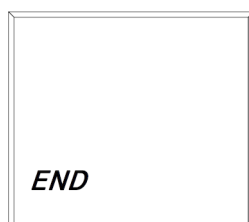

- (5) Press the DISPLAY switch to return to the display/setting mode menu.  
 (6) After completion, press the DISPLAY switch to return to the detection mode.

## <SnapLog Data Display [REC.DATA]> (GX-2012, GX-2012GT <Normal Mode>)

Display concentration data recorded to the manual memory.

- (1) Press the DISPLAY switch and select the log data display from the display/setting mode menu. The following screens are displayed in turn on the gas monitor.

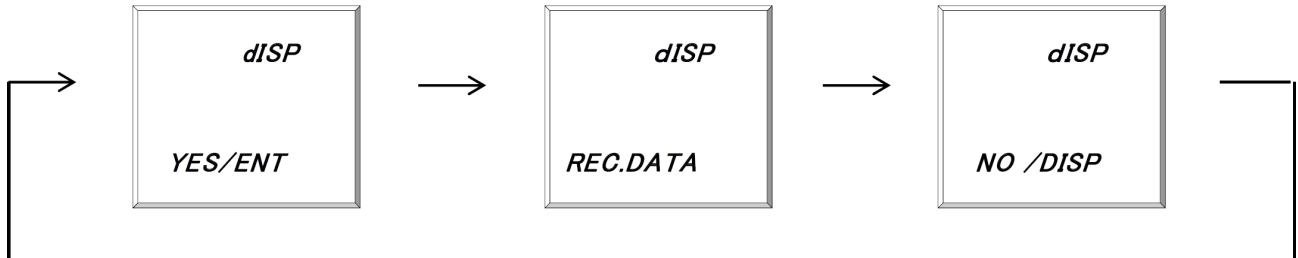

- (2) Press the ENTER switch to display the log data.

### NOTE

If you do not want to display the log data, press the DISPLAY switch to return to the display/setting mode menu.

- (3) Every time the ▲ or ▼ switch is pressed, the log data menus are displayed in turn. Press either the ▲ or ▼ switch to select log data that you want to check. The log data menu displays the year, month, day, time, and memory number.

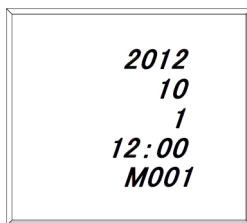

- (4) Press the ENTER switch to display the selected log data.

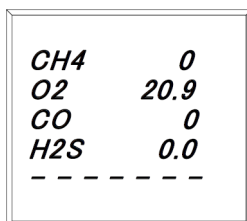

- (5) If you want to display other log data, press the ENTER switch to return to the log data menu. Repeat the steps (3) - (5).

- (6) After completion, press the DISPLAY switch to return to the detection mode.

### <Peak Display ON/OFF Setting [bAr SEL]> (GX-2012, GX-2012GT <Normal Mode>)

Selects ON (display)/OFF (hide) of the peak display in the bar graph.

- (1) Press the DISPLAY switch and select the Peak ON/OFF setting from the display/setting mode menu. The following screens are displayed in turn on the gas monitor.



- (2) Press the ENTER switch to change the setting.

#### NOTE

If you do not want to change the setting, press the DISPLAY switch to return to the display/setting mode menu.

- (3) Every time the ▲ or ▼ switch is pressed, [On PEAK BAR] (display) and [OFF PEAK BAR] (non-display) are displayed alternately on the ON/OFF setting menu. Select ON/OFF setting and press the ENTER switch.

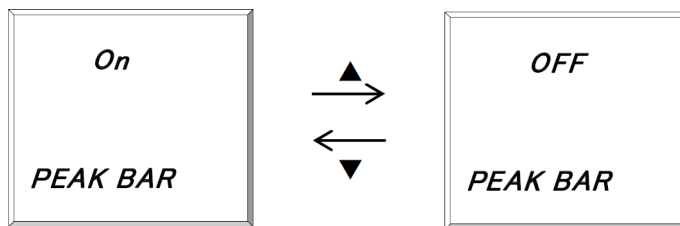

- (4) When [END] is displayed, the setting is completed.

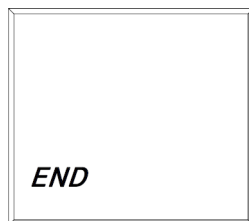

The display/setting mode menu is displayed again.

- (5) After completion, press the DISPLAY switch several times until it returns to the detection mode.

#### NOTE

After ON (display) setting is performed, gas concentration will be displayed as the bar graph level as well as numeric value as shown in the figure on the right.

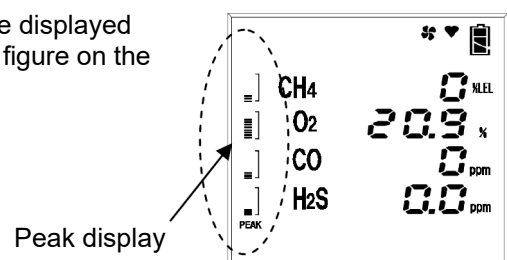

## **4-9. How to exit**

Make the gas monitor draw in fresh air. After the display returns to zero (or 20.9 % for oxygen), keep the POWER/ENTER switch pressed until the power is turned off.

## 5

# Operations and Functions

## 5-1. Gas alarm activation (GX-2012, GX-2012GT <Normal Mode>)

Gas alarm: Triggered when the concentration of detected gas reaches or exceeds the alarm setpoint value. <<Self-latching>>

Alarm display: Notifies by blinking of a gas concentration value display, sounding of the buzzer, and lighting of the lamp.

Alarm types: First alarm (WARNING), second alarm (ALARM), OVER alarm, TWA alarm, and STEL alarm (\* Operations are slightly different depending on the type)

### <List of Gas Alarms>

Alarm type	First alarm	Second alarm	OVER alarm	TWA alarm	STEL alarm
Oxygen	19.5 % (Japan specification) 19.5 % (Export specification)	18.0 % (Japan specification) 23.5 % (Export specification)	40.0 %	–	–
Combustible gas	10 %LEL	50 %LEL	100 %LEL	–	–
Hydrogen sulfide	1.0 ppm (Japan specification) 5.0 ppm (Export specification)	10.0 ppm (Japan specification) 30.0 ppm (Export specification)	30.0 ppm (Japan specification) 30.0 ppm (Export specification)	1.0 ppm (Japan specification) 10.0 ppm (Export specification)	5.0 ppm (Japan specification) 15.0 ppm (Export specification)
Carbon monoxide	25 ppm	50 ppm	500 ppm	25 ppm	200 ppm
Buzzer	Repeatedly sounds strong and weak beeps at about 1 second intervals. Beep, beep	Repeatedly sounds strong and weak beeps at about 0.5 second intervals. Blip, blip	Repeatedly sounds strong and weak beeps at about 0.5 second intervals. Blip, blip	Repeatedly sounds strong and weak beeps at about 1 second intervals. Beep, beep	Repeatedly sounds strong and weak beeps at about 1 second intervals. Beep, beep
Alarm lamp	Repeatedly blinks at about 1 second intervals.	Repeatedly blinks at about 0.5 second intervals.	Repeatedly blinks at about 0.5 second intervals.	Repeatedly blinks at about 1 second intervals.	Repeatedly blinks at about 1 second intervals.
LCD display	Gas concentration and [WARNING] display blink.	Gas concentration and [ALARM] display blink.	Gas concentration and [OVER] display blink.	Gas concentration and [TWA] display blink.	Gas concentration and [STEL] display blink.

### <Display Operation>

#### Gas Concentration Display

In a gas alarm, the gas concentration display and the alarm type display blink.

When the concentration of gas exceeds the detection range (over scale), [∞∞∞] will be displayed on the LCD screen.

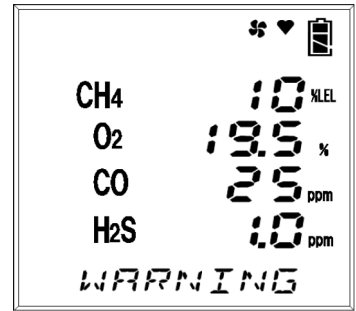

Display example

#### Alarm lamp

The alarm consists of two steps. Each of them is triggered when the respective alarm setpoint value is reached or exceeded.

#### Buzzer

The alarm consists of two steps. Each of them sounds when the respective alarm setpoint value is reached to or exceeded.

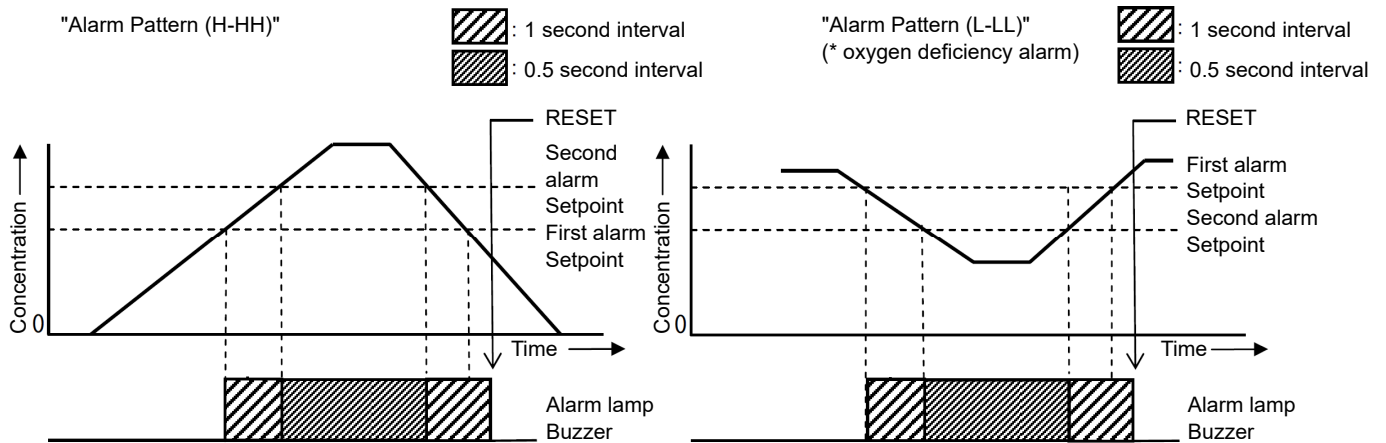

### WARNING

Issuance of a gas alarm indicates that there are extreme dangers. Take proper actions based on your judgment.



## 5-2. Fault alarm activation

Fault alarm: Triggered when an abnormality is detected in the gas monitor. <<Self-latching>>

Alarm display: Notifies by display of error messages, sounding of the buzzer, and lighting of the lamp.

Alarm types: Low flow rate, sensor abnormality, battery voltage low, system abnormality, and calibration failure

Determine the causes and take appropriate actions.

If the gas monitor has problems and is repeatedly malfunctioning, contact RIKEN KEIKI immediately.

### <Display Operation>

LCD display	Displays an error message.
Alarm lamp	Repeatedly blinks at about one second intervals.
Buzzer	Repeatedly sounds intermittent beeps at about one second intervals: Blip, beep, blip, beep

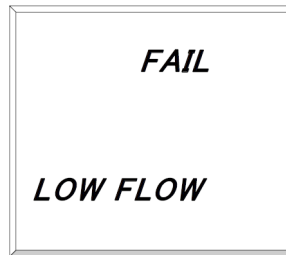

Display example

### NOTE

- To reset a low flow rate alarm ([FAIL LOW FLOW]), remove the cause of the low flow rate, and then press the RESET switch.
- For information on malfunctions (error messages), see '8. Troubleshooting'.

## 5-3. Other functions

### <Calibration History/Various Trend/Event History Functions>

(GX-2012, GX-2012GT <Normal Mode>)

The gas monitor has history and trend functions. To use these functions, contact RIKEN KEIKI.

#### NOTE

The data logger management program (option) is required to use the history and trend functions. Please contact RIKEN KEIKI.

Data logger provides five functions.

(1) Interval trend

Records the change of measured concentration from the time the power is turned ON until the time the power is turned OFF.

The most latest 100 times worth of measurement data shall be recorded.

When the measurement is conducted more than 100 times, the oldest data will be overwritten by the latest data.

\* However, when the maximum recording time is exceeded, the oldest data will be overwritten even before the 100th measurement.

The maximum recording time is specified as follows for each interval time.

Interval Time	10 seconds	30 seconds	1 minute	3 minutes	5 minutes	10 minutes
Maximum Recording Time	10 hours	30 hours	60 hours	180 hours	300 hours	600 hours

\* The standard interval time is "5 minutes."

Interval time can be set by "Data Logger Management Program" (optional).

(2) Alarm trend

Starting immediately after the alarm is triggered, this function records the change of measured concentration for one hour, which is from 30 minutes before the alarm was triggered until 30 minutes after the alarm was triggered.

Alarm trend records the peak value of five-second time at a 5-second interval.

Last eight measurement data shall be recorded.

When the number of data exceeds eight, the oldest data will be overwritten by the latest data.

(3) Alarm event

Records the trigger of alarm as an event.

The event records the time of alarm trigger, the target gas of measurement, and the type of alarm event (AL1, AL2, OVER).

Up to 100 events are recorded, counting backwards from the latest event.

When the number of events exceeds 100, the oldest data will be overwritten by the latest data.

(4) Trouble event

Records the trigger of trouble as an event.

The event records the time when the trouble was triggered, the target gas of measurement, and the type of fault event.

Up to 100 events are recorded, counting backwards from the latest event.

When the number of events exceeds 100, the oldest data will be overwritten by the latest data.

(5) Calibration history

Records data when the calibration is performed.

The history records the calibration time, concentration value before and after the calibration, as well as the calibration error.

Up to 100 calibration data are recorded, counting backwards from the latest calibration.

When the calibration is conducted more than 100 times, the oldest data will be overwritten by the latest data.

**NOTE**

- Data logger function of this gas monitor is entirely based on the overwrite system (the oldest data is deleted and the latest data is recorded).
  - The recorded data can be read out by the "Data Logger Management Program" (option). For details, see Operating Manual 'Data Logger Management Program.'
-

---

## 6

---

# Maintenance

The gas monitor is an important instrument for the purpose of safety. To maintain the performance of the gas monitor and improve the reliability of safety, perform a regular maintenance.

### 6-1. Maintenance intervals and items

- Daily maintenance: Perform maintenance before beginning to work.
- Monthly maintenance: Perform alarm test once a month.
- Regular maintenance: Perform maintenance once or more every six months to maintain the performance as a safety unit.

Maintenance item	Maintenance content	Daily maintenance	Monthly maintenance	Regular maintenance
Battery level check	Check that the battery level is sufficient.	○	○	○
Concentration display check	Make the gas monitor draw in fresh air. Check that the concentration display value is zero (or 20.9 vol% on the oxygen deficiency meter). When the reading is incorrect, perform the zero adjustment (fresh air adjustment) after ensuring that no other gases exist around it.	○	○	○
Checking the operation of the main unit	See the pilot indicator to check for abnormalities.	○	○	○
Checking the operation of the pump	See the pump operation status indicator to check for abnormalities.	○	○	○
Filter check	Check the dust filter for dust or clogging.	○	○	○
Alarm test	Check the alarm lamp and buzzer for normal operation using the alarm test function.	-	○	○
Span adjustment	Perform the span adjustment by using the calibration gas.	-	-	○
Gas alarm check	Check the gas alarm by using the calibration gas.	-	-	○

## <About Maintenance Services>

- We provide services on regular maintenance including span adjustment, other adjustments and maintenance.  
To make the calibration gas, dedicated tools, such as a gas cylinder of the specified concentration and gas sampling bag must be used.  
Our qualified service engineers have expertise and knowledge on the dedicated tools used for services, along with other products. To maintain the safety operation of the gas monitor, please use our maintenance service.
- The followings are typical maintenance services. For more information, please contact RIKEN KEIKI.

### Main Services

Battery level check	: Checks the battery level.
Concentration display check	: Verifies that the concentration display value is zero (or 20.9 vol% on the oxygen deficiency meter) by using the zero gas. Performs the zero adjustment (fresh air adjustment) if the reading is incorrect.
Flow rate check	: Checks the flow rate indicator to find abnormalities. Checks the flow rate by using an external flow meter to verify the correctness of the flow rate indicator on the gas monitor. If the flow rate is incorrect, performs the flow rate adjustment.
Filter check	: Checks the dust filter for dust or clogging. Replaces a dirty or clogged dust filter.
Alarm test	: Checks the alarm lamp and buzzer for normal operation using the alarm test function.
Span adjustment	: Performs the span adjustment by using the calibration gas.
Gas alarm check	: Checks the gas alarm by using the calibration gas. <ul style="list-style-type: none"> <li>• Checks the alarm. (Checks the alarm activation when the alarm setpoint is reached)</li> <li>• Checks the delay time. (Checks time to delay until the alarm is triggered)</li> <li>• Checks the buzzer, lamp, and concentration display. (Check each activation of ALM1 and ALM2)</li> </ul>
Cleaning and repair of device (visual diagnosis)	: Checks dust or damage on surface of the gas monitor, clean and repair such parts of the gas monitor. Replaces parts which are cracked or damaged.
Device operation check	: Uses the keys to check the operation of functions and parameters.
Replacement of Consumable Parts	: Replaces consumable parts, such as a sensor, filter and pump.

## 6-2. Gas calibration method

Perform span adjustment of sensors using a calibration gas at least once every six months.  
Request the dealer or RIKEN KEIKI headquarters or authorized local representative to perform span adjustment.



### **CAUTION**

Do not use a lighter gas to check the sensitivity of the gas monitor. A constituent of the lighter gas may deteriorate the sensor performances.

## 6-3. How to clean

Clean the gas monitor if it becomes extremely dirty. The gas monitor must be turned off while cleaning it. Use a waste cloth to remove dust. Do not use water or organic solvent for cleaning because they may cause malfunctions.

Because an extremely large amount of dust inside the taper nozzle may disturb the gas detection, it must be cleaned with dry AIR, etc.



### CAUTION

When cleaning the gas monitor, do not splash water over it or use organic solvents such as alcohol and benzene on it. The surface of the gas monitor may be discolored or damaged.

### NOTE

When the gas monitor gets wet, water may remain in the buzzer sound opening or clearances. Drain water as follows:

- (1) Wipe away moisture on the gas monitor thoroughly using a dry towel, cloth, etc.
- (2) While holding the gas monitor firmly, shake it about ten times with the buzzer sound opening facing downward.
- (3) Wipe away moisture coming out from the inside thoroughly using a towel, cloth, etc.
- (4) Place the gas monitor on a dry towel, cloth, etc. and let it stand at normal temperatures.

## 6-4. Parts replacement

### <Replacement of Consumables>

#### Sensor Replacement

The built-in sensors of the gas monitor have a validity period and must be replaced regularly (within two years).

The sensor life has expired if, for example, the sensors cannot be calibrated in span adjustment, the readings do not come back after fresh air adjustment, or the readings fluctuate. Contact RIKEN KEIKI. The warranty period is one year for all the sensors.

#### Dust Filter Replacement Procedure

Because the dust filter may gradually get dirty or clogged over the time, it must be replaced regarding the operating conditions. Check the dust filter, and then replace it as necessary.

#### Gas inlet part

The gas inlet part contains absorbent cotton, wire mesh filter, and Teflon filter. Replace the filter when it has absorbed water, has a low flow rate, or looks significantly contaminated.

- (1) Turn the filter case counterclockwise and remove it.
- (2) Take out the filter and replace with a new filter.

### NOTE

The absorbent cotton is installed on the filter case side and the Teflon filter and wire mesh filter are installed on the main unit side.

(3) Attach the filter case that has been removed.

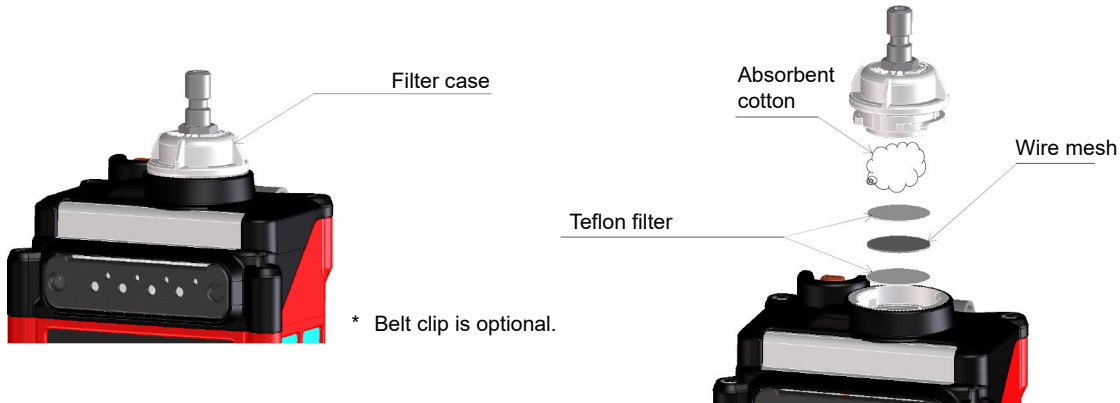

Sensor part

The sensor part contains various filters. The filters need to be replaced regularly. (\*Different filters are attached depending on the type)



**CAUTION**

- Turn off the power of the gas monitor before replacing the filters.
- Do not remove the cover except for when replacing the filter. When the sensor cover is not attached properly, accurate measurement may not be possible due to leaks, or water may get inside.
- Use the dedicated filters for this gas monitor only. Using a similar product may have harmful effects on the gas detection performance.

(1) Remove the battery unit, loosen the three screws of the sensor cover and remove the sensor cover.

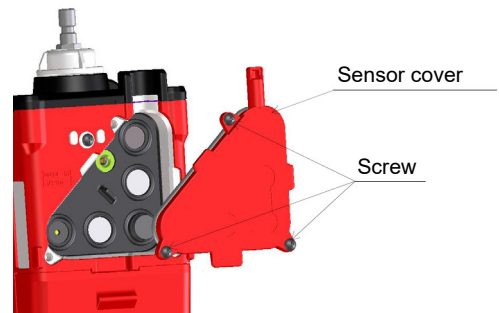

(2) Take out the filters and replace them.



(3) Attach the sensor cover to the main unit and tighten the three screws.



## CAUTION

If the screws are not tightened completely, accurate gas measurement may not be possible due to leaks, or water may get inside. The same thing occurs if a minute foreign substance is caught beneath the knob.

## <Replacement of Regular Replacement Parts>

### List of recommended regular replacement parts

#### GX-2012

No.	Item	Recommended maintenance interval	Recommended replacement interval	Quantity (pieces per unit)	Remarks
1	Pump unit (RP-12)	6 months	1 - 2 years	1	
2	H <sub>2</sub> S sensor filter	3 months	6 months	1	Humidity control filter
3	CO sensor filter	3 months	6 months	1	Activated carbon filter
4	HC-LEL sensor filter	3 months	6 months	1	Hydrogen sulfide scrubber filter
5	Absorbent cotton	–	When dirty	Proper quantity	
6	Teflon filter	3 months	6 months	1	
7	Lithium ion battery unit: (BUL-2012,BUL-2012(G1))	–	About 500 cycles of charging and discharging	1	Customers who purchased lithium ion battery unit (optional accessories)

#### GX-2012GT

No.	Item	Recommended maintenance interval	Recommended replacement interval	Quantity (pieces per unit)	Remarks
1	Pump unit (RP-12)	6 months	1 - 2 years	1	
2	CO sensor filter	3 months	6 months	1	Activated carbon filter
3	HC-LEL sensor filter	3 months	6 months	1	Hydrogen sulfide scrubber filter
4	Absorbent cotton	–	When dirty	Proper quantity	
5	Teflon filter	3 months	6 months	1	
6	Lithium ion battery unit: (BUL-2012,BUL-2012(G1))	–	About 500 cycles of charging and discharging	1	Customers who purchased lithium ion battery unit (optional accessories)

## NOTE

The above replacement intervals are recommendation only. The intervals may change depending on the operating conditions. These intervals do not mean the warranty periods either. The result of the regular maintenance may determine when to replace the parts.

The operation of most of the periodical replacement parts must be checked after replacement by a qualified service engineer.

For the stable operation of the detector and safety, ask a qualified service engineer to take care of replacement of the parts whose operation must be checked. Please contact RIKEN KEIKI.



---

# 7

---

## Storage and Disposal

### 7-1. Procedures to store the gas monitor or leave it for a long time

The gas monitor must be stored under the following environmental conditions.

- In a dark place under the normal temperature and humidity away from direct sunlight
- In a place where gases, solvents or vapors are not present

Store the gas monitor in a shipping carton, if any, in which the product was delivered. Store the gas monitor away from dust, etc. if the shipping carton is not available.



#### CAUTION

If the gas monitor is not used for a long time, turn on the power at least once every six months and check that the pump draws in air (about three minutes). The gas monitor, when not activated for a long time, may cease to work because of hardening of the grease in the pump motor.

#### NOTE

- If the gas monitor with a lithium ion battery unit is not used for a long time, it is recommended to store it after discharging the batteries until the battery level icon shows one battery mark or so. If the gas monitor is stored with the batteries fully charged, the batteries get deteriorated more quickly and may have shorter life.
- If the gas monitor with a dry battery unit is not used for a long time, store it after removing the batteries. Battery leaks may result in fire or injury. If the gas monitor is not used for a short time, store it without removing the batteries. While the power of the gas monitor is OFF, the sensor is energized at all times. Therefore, it is necessary to store the gas monitor with the batteries in it.

### 7-2. Procedures to use the gas monitor again



#### CAUTION

When you use a stopped or stored gas monitor again, never fail to perform a gas calibration. For information on readjustment including gas calibration, please contact RIKEN KEIKI.

## 7-3. Disposal of products

- When the gas monitor is disposed of, it must be treated properly as an industrial waste in accordance with the local regulations.



### WARNING

- Do not disassemble the electrochemical type sensor or galvanic cell type sensor because they contain electrolyte. Electrolyte may cause severe skin burns if it contacts skin, while it may cause blindness if it contacts eyes. If electrolyte is adhered on your clothes, that part on your clothes is discolored or its material is decomposed. If contact occurs, rinse the area immediately with a large quantity of water.
  - Dispose of the batteries or the battery unit in accordance with the procedure specified by the local authority.
- 
- When disposing of the gas monitor in EU member states, sort the batteries as specified. Handle the removed batteries according to the classified refuse collection system and recycling system based on the regulations of EU member states.

#### Removing batteries

See '4-2. Preparation for start-up' and take out the batteries.

When BUL-2012,BUL-2012(G1) (option) is used

Model	Type
BUL-2012 BUL-2012(G1)	Lithium ion battery

### NOTE

- BUL-2012,BUL-2012(G1) (option) contains batteries.
- Crossed-out recycle dustbin mark



This symbol mark is indicated on the products which contain the batteries which fall under EU Battery Directive 2006/66/EC. Such batteries need to be disposed of as specified by the latest Directive. This symbol mark indicates that the batteries need to be separated from the ordinary waste and disposed of appropriately.

## 8

# Troubleshooting

The troubleshooting does not explain the causes of all the malfunctions which occur on the gas monitor. This simply helps to find the causes of malfunctions which frequently occur. If the gas monitor shows a symptom which is not explained in this manual, or still has malfunctions even though remedial actions are taken, please contact RIKEN KEIKI.

## <Abnormalities on Unit>

Symptoms	Causes	Actions
<u>The power cannot be turned on.</u>	The battery level is too low.	Dry battery unit: Replace all the three dry batteries with the new ones in a non-hazardous area. Lithium ion battery unit: Charge the batteries in a non-hazardous area.
	The power switch was not pressed long enough.	For power-on, keep the POWER switch pressed until a beep is heard.
	Improper installation of the battery unit	Check whether the battery unit is properly attached to the main unit.
<u>Abnormal operations</u>	Disturbances by sudden static electricity noise, etc.	Turn off and restart the gas monitor.
<u>Key operations are disabled.</u>	Disturbances by sudden static electricity noise, etc.	In a non-hazardous area, remove the battery unit once, and reinstall the battery unit, and turn on the power to perform operations.
<u>System abnormalities</u> [FAIL SYSTEM]	A circuit abnormality occurred.	Request RIKEN KEIKI for repair.
<u>System abnormalities</u> [FAIL SYSTEM] Error No. 000	Abnormalities of internal ROM	Request RIKEN KEIKI for repair.
Error No. 010	Abnormalities of internal RAM	
Error No. 021	Abnormalities of internal FRAM	
Error No. 022	Abnormalities of internal FLASH memory	
<u>Sensor abnormalities</u> [FAIL SENSOR]	A sensor has failed.	Request RIKEN KEIKI to replace the sensor. (Only at power-on, press the RESET switch to continue the operation using only the normal sensors to detect other gases.)

Symptoms	Causes	Actions
<u>A low battery voltage alarm is displayed.</u> [FAIL BATTERY]	The battery level is low.	Dry battery unit: Turn off the power and replace the dry batteries with new ones in a non-hazardous area.
		Lithium ion battery unit: Turn off the power and charge it in a non-hazardous area.
<u>A low flow rate alarm is displayed.</u> [FAIL LOW FLOW]	Water or oil, etc. was drawn in.	Check the gas sampling hose for any damage or mark of drawn water or oil, etc.
	The filter is clogged.	Check the attachment, clogging, torsion, etc. of the filter.
	The pump has deteriorated.	Request RIKEN KEIKI to replace the pump.
	The unit was stored for a long time without being used (6 months or longer)	When the low flow rate alarm is displayed, turn off the unit once and then on again. Repeat this procedure several times. If the problem still persists, request RIKEN KEIKI to replace the pump.
<u>Fresh air adjustment cannot be performed.</u> [FAIL AIR CAL]	Fresh air is not supplied around the gas monitor.	Supply fresh air.
<u>Clock abnormalities</u> [FAIL CLOCK]	Abnormalities of the internal clock	Make a setting of Date/Time. If such a symptom is observed repeatedly, the built-in clock is seemingly malfunctioning. Thus, it must be replaced. Please contact RIKEN KEIKI.
<u>The batteries cannot be recharged.</u> (Rechargeable battery unit only)	The charger is not connected properly.	Connect the AC plug and DC plug of the AC powered charger properly.
	A charging circuit abnormality occurred.	Request RIKEN KEIKI for repair.
	The batteries have been fully charged.	When fully charged batteries are charged again, the charging indicator lamp does not go on.

## &lt;Abnormalities of Readings&gt;

Symptoms	Causes	Actions
<u>The reading rises (drops) and it remains so.</u>	Drifting of sensor output	Perform the zero adjustment.
	Presence of interference gas	Disturbances by interference gases, such as solvents, cannot be eliminated completely.
	Slow leak	A very small amount of the gas to be detected may be leaking (slow leak). Because ignoring it may cause dangers, take a remedial measure, i.e., taking actions the same as those for the gas alarm.
<u>A gas alarm is triggered despite of no gas leak and no other abnormalities at the detection point.</u>	Environmental changes	Perform the zero adjustment. In particular, the galvanic cell type is affected by the air pressure.
	Presence of interference gas	Disturbances by interference gases, such as solvents, cannot be eliminated completely.
<u>Slow response</u>	Disturbance by noise	Turn off and restart the gas monitor. If such a symptom is observed frequently, take appropriate measures to eliminate the noise.
	Clogged dust filter	Replace the dust filter.
	Bended or clogged taper nozzle	Fix the defective parts.
	Condensation is formed inside the gas monitor.	Fix the defective parts by providing dry air, etc.
<u>Span adjustment impossible</u>	Deteriorated sensor sensitivity	Replace the sensor with a new one.
	Improper calibration gas concentration	Use the proper calibration gas.
	Deteriorated sensor sensitivity	Replace the sensor with a new one.

## 9

# Product Specifications

## 9-1. List of specifications

### GX-2012 <Japan Ex specifications>

Detection principle	Galvanic cell type (OS)	New ceramic type (NC) /Thermal conductivity type (TE)(*)	Electrochemical type (ES)	Electrochemical type (ES)
Gas to be detected	Oxygen (O <sub>2</sub> )	Combustible gas (HC/CH <sub>4</sub> )	Hydrogen sulfide (H <sub>2</sub> S)	Carbon monoxide (CO)
Detection range <Service range>	0 - 25 vol% <Up to 40 vol%>	0 - 100 %LEL (NC) /Up to 100 vol%(TE)(*)	0 - 30 ppm	0 - 150 ppm <Up to 500 ppm>
Display resolution	0.1 vol%	1 %LEL(NC)/1 vol%(TE)	0.1 ppm	1 ppm
Alarm setpoint value	19.5 vol% (L) 18.0 vol% (LL) 40.0 vol% (OVER)	10 %LEL (1st) 50 %LEL (2nd) 100 %LEL (OVER)	1.0 ppm (1st) 10.0 ppm (2nd) 1.0 ppm (TWA) 5.0 ppm (STEL) 30.0 ppm (OVER)	25 ppm (1st) 50 ppm (2nd) 25 ppm (TWA) 200 ppm (STEL) 500 ppm (OVER)
Display	LCD digital (seven-segment + symbol)			
Detection method	Sample-drawing			
Flow rate	0.45 L/min or more (Open flow rate)			
Displays	Clock display, battery level icon, pilot indicator, and pump operation status indicator			
Buzzer sound volume	95 dB (A) or higher (30 cm)			
Gas alarm display	Lamp blinking, continuous modulating buzzer sounding, gas concentration display blinking, and vibration			
Gas alarm pattern	Self-latching			
Fault alarm/self diagnosis	System abnormalities, sensor abnormalities, battery voltage drop, calibration failure, and low flow rate			
Fault alarm display	Lamp blinking, intermittent buzzer sounding, and detail display			
Fault alarm pattern	Self-latching			
Transmission specifications	IrDA (for data logger)			
Functions	LCD backlight, data logger, peak display, log data display			
Power supply	Dedicated dry battery unit <AA alkaline dry batteries × 3> [BUD-2012] (Dedicated lithium ion battery unit [BUL-2012,BUL-2012(G1)] can also be used)			
Continuous operating time	BUD-2012: About 15 hours (25 °C, no alarm, and no lighting) BUL-2012,BUL-2012(G1): About 10 hours (25 °C, no alarm, no lighting, and battery fully charged)			
Operating temperature	-20 - +50 °C			
Operating humidity	Below 95 %RH (Non-condensing)			
Structure	Drip-proof and dust-proof performances (compliant to IP67 level)			
Explosion-proof structure	Intrinsically safe explosion-proof structure			
Explosion-proof class	Ex ia IIC T4 X (Japan Ex)			
Dimension	Approx. 71 (W) × 173 (H) × 43 (D) mm (projection portions excluded)			
Weight	Approx. 360 g (When BUD-2012 is used)/Approx. 360 g (When BUL-2012,BUL-2012(G1) are used)			

\* Specifications subject to changes without notice.

\* Detection of high-concentration combustible gases (vol%) is only possible with CH<sub>4</sub> specification type.

GX-2012 <ATEX/IECEX/UKEX specifications>

Detection principle	Galvanic cell type (OS)	New ceramic type (NC) /Thermal conductivity type (TE)(*)	Electrochemical type (ES)	Electrochemical type (ES)
Gas to be detected	Oxygen (O <sub>2</sub> )	Combustible gas (HC/CH <sub>4</sub> )	Hydrogen sulfide (H <sub>2</sub> S)	Carbon monoxide (CO)
Detection range <Service range>	0 - 25 vol% <Up to 40 vol%>	0 - 100 %LEL (NC) /Up to 100 vol% (TE)(*)	0 - 30 ppm	0 - 150 ppm <Up to 500 ppm>
Display resolution	0.1 vol%	1 %LEL(NC)/1 vol%(TE)	0.1 ppm	1 ppm
Alarm setpoint value	19.5 vol% (L) 23.5 vol% (H) 40.0 vol% (OVER)	10 %LEL (1st) 50 %LEL (2nd) 100 %LEL (OVER)	5.0 ppm (1st) 30.0 ppm (2nd) 10.0 ppm (TWA) 15.0 ppm (STEL) 30.0 ppm (OVER)	25 ppm (1st) 50 ppm (2nd) 25 ppm (TWA) 200 ppm (STEL) 500 ppm (OVER)
Display	LCD digital (seven-segment + symbol)			
Detection method	Sample-drawing			
Flow rate	0.45 L/min or more (Open flow rate)			
Displays	Clock display, battery level icon, pilot indicator, and pump operation status indicator			
Buzzer sound volume	95 dB (A) or higher (30 cm)			
Gas alarm display	Lamp blinking, continuous modulating buzzer sounding, gas concentration display blinking, and vibration			
Gas alarm pattern	Self-latching			
Fault alarm/self diagnosis	System abnormalities, sensor abnormalities, battery voltage drop, calibration failure, and low flow rate			
Fault alarm display	Lamp blinking, intermittent buzzer sounding, and detail display			
Fault alarm pattern	Self-latching			
Transmission specifications	IrDA (for data logger)			
Functions	LCD backlight, data logger, peak display, log data display			
Power supply	Dedicated dry battery unit <AA alkaline dry batteries × 3> [BUD-2012] (Dedicated lithium ion battery unit [BUL-2012,BUL-2012(G1)] can also be used)			
Continuous operating time	BUD-2012: About 15 hours (25 °C, no alarm, and no lighting) BUL-2012,BUL-2012(G1): About 10 hours (25 °C, no alarm, no lighting, and battery fully charged)			
Operating temperature	-20 to +50°C			
Operating humidity	Below 95 %RH (Non-condensing)			
Structure	Drip-proof and dust-proof performances (compliant to IP67 level)			
Explosion-proof structure	Intrinsically safe explosion-proof structure			
Explosion-proof class	ATEX/UKEX II 1G Ex ia II C T4 Ga (without combustible LEL gas sensor) II 1G Ex ia II B T4 Ga (with combustible LEL gas sensor) IECEX Ex ia II C T4 Ga (without combustible LEL gas sensor) Ex ia II B T4 Ga (with combustible LEL gas sensor)			
Dimension	Approx. 71 (W) × 173 (H) × 43 (D) mm (projection portions excluded)			
Weight	Approx. 360 g (When BUD-2012 is used)/Approx. 360 g (When BUL-2012,BUL-2012(G1) are used)			

\* Specifications subject to changes without notice.

\* Detection of high-concentration combustible gases (vol%) is only possible with CH<sub>4</sub> specification type.Combination of Detectable Gases by Type

	Oxygen (O <sub>2</sub> )	Combustible gas (HC or CH <sub>4</sub> )	Combustible gas (CH <sub>4</sub> )	Hydrogen sulfide (H <sub>2</sub> S)	Carbon monoxide (CO)
	0 - 25 vol% <Up to 40 vol%>	0 - 100 %LEL	0 - 100 VOL%	0 - 30 ppm	0 - 150 ppm < Up to 500 ppm>
Type A	●	●	●	●	●
Type B	●	●	-	●	●
Type C	●	●	-	●	-
Type D	●	●	-	-	●
Type E	●	●	●	-	-
Type F	●	●	-	-	-

## GX-2012GT &lt;Japan Ex specifications&gt;

Detection principle	Galvanic cell type (OS)	New ceramic type (NC) /Thermal conductivity type (TE)(*)	Hot-wire semiconductor type (SH)	Electrochemical type (ES)
Gas to be detected	Oxygen (O <sub>2</sub> )	Combustible gas (HC/CH <sub>4</sub> )	Combustible gas (HC/CH <sub>4</sub> )	Carbon monoxide (CO)
Detection range <Service range>	0 - 25 vol% <Up to 40 vol%>	0 - 100 %LEL (NC) /Up to 100 vol%(TE)(*)	0 - 500 ppm (HC) <510 - 2000 ppm>(HC) 0 - 2000 ppm(CH <sub>4</sub> ) <2010 - 5000 ppm>(CH <sub>4</sub> )	0 - 150 ppm <Up to 500 ppm>
Display resolution	0.1 vol%	1 %LEL(NC)/1 vol%(TE)	10 ppm	1 ppm
Alarm setpoint value	19.5 vol% (L) 18.0 vol% (LL) 40.0 vol% (OVER)	10 %LEL (1st) 50 %LEL (2nd) 100 %LEL (OVER)	-	25 ppm (1st) 50 ppm (2nd) 25 ppm (TWA) 200 ppm (STEL) 500 ppm (OVER)
Display	LCD digital (seven-segment + symbol + bar display)			
Detection method	Sample-drawing			
Flow rate	0.45 L/min or more (Open flow rate)			
Displays	Clock display, battery level icon, pilot indicator, and pump operation status indicator			
Buzzer sound volume	95 dB (A) or higher (30 cm)			
Gas alarm display	Lamp blinking, continuous modulating buzzer sounding, gas concentration display blinking, and vibration			
Gas alarm pattern	Self-latching			
Fault alarm/self diagnosis	System abnormalities, sensor abnormalities, battery voltage drop, calibration failure, and low flow rate			
Fault alarm display	Lamp blinking, intermittent buzzer sounding, and detail display			
Fault alarm pattern	Self-latching			
Transmission specifications	IrDA (for data logger)			
Functions	LCD backlight, data logger, peak display, log data display, leak check			
Power supply	Dedicated dry battery unit <AA alkaline dry batteries × 3> [BUD-2012] (Dedicated lithium ion battery unit [BUL-2012,BUL-2012(G1)] can also be used)			
Continuous operating time	BUD-2012: About 15 hours (25 °C, no alarm, and no lighting [normal mode]) BUD-2012: About 5.5 hours (25 °C, no alarm, and no lighting [leak check mode]) BUL-2012,BUL-2012(G1): About 10 hours (25 °C, no alarm, no lighting, and battery fully charged [normal mode]) BUL-2012,BUL-2012(G1): About 4 hours (25 °C, no alarm, no lighting, and battery fully charged [leak check mode])			
Operating temperature	-20 - +50 °C			
Operating humidity	Below 95 %RH (Non-condensing)			
Structure	Drip-proof and dust-proof performances (compliant to IP67 level)			
Explosion-proof structure	Intrinsically safe explosion-proof structure			
Explosion-proof class	Ex ia II C T4 X (Japan Ex)			
Dimension	Approx. 71 (W) × 173 (H) × 43 (D) mm (projection portions excluded)			
Weight	Approx. 360 g (When BUD-2012 is used)/Approx. 360 g (When BUL-2012,BUL-2012(G1) are used)			

\* Specifications subject to changes without notice.

\* Detection of high-concentration combustible gases (vol%) is only possible with CH<sub>4</sub> specification type.



**GX-2012GT <ATEX/IECEX/UKEX specifications>**

Detection principle	Galvanic cell type (OS)	New ceramic type (NC) /Thermal conductivity type (TE)(*)	Hot-wire semiconductor type (SH)	Electrochemical type (ES)
Gas to be detected	Oxygen (O <sub>2</sub> )	Combustible gas (HC/CH <sub>4</sub> )	Combustible gas (HC/CH <sub>4</sub> )	Carbon monoxide (CO)
Detection range <Service range>	0 - 25 vol% <Up to 40 vol%>	0 - 100 %LEL (NC) /Up to 100 vol%(TE)(*)	0 - 500 ppm(HC) <510 - 2000 ppm>(HC) 0 - 2000 ppm(CH <sub>4</sub> ) <2010 - 5000 ppm>(CH <sub>4</sub> )	0 - 150 ppm <Up to 500 ppm>
Display resolution	0.1 vol%	1 %LEL(NC)/1 vol%(TE)	10 ppm	1 ppm
Alarm setpoint value	19.5 vol% (L) 23.5 vol% (H) 40.0 vol% (OVER)	10 %LEL (1st) 50 %LEL (2nd) 100 %LEL (OVER)	-	25 ppm (1st) 50 ppm (2nd) 25 ppm (TWA) 200 ppm (STEL) 500 ppm (OVER)
Display	LCD digital (seven-segment + symbol + bar display)			
Detection method	Sample-drawing			
Flow rate	0.45 L/min or more (Open flow rate)			
Displays	Clock display, battery level icon, pilot indicator, and pump operation status indicator			
Buzzer sound volume	95 dB (A) or higher (30 cm)			
Gas alarm display	Lamp blinking, continuous modulating buzzer sounding, gas concentration display blinking, and vibration			
Gas alarm pattern	Self-latching			
Fault alarm/self diagnosis	System abnormalities, sensor abnormalities, battery voltage drop, calibration failure, and low flow rate			
Fault alarm display	Lamp blinking, intermittent buzzer sounding, and detail display			
Fault alarm pattern	Self-latching			
Transmission specifications	IrDA (for data logger)			
Functions	LCD backlight, data logger, peak display, log data display, leak check			
Power supply	Dedicated dry battery unit <AA alkaline dry batteries × 3> [BUD-2012] (Dedicated lithium ion battery unit [BUL-2012,BUL-2012(G1)] can also be used)			
Continuous operating time	BUD-2012: About 15 hours (25 °C, no alarm, and no lighting [normal mode]) BUD-2012: About 5.5 hours (25 °C, no alarm, and no lighting [leak check mode]) BUL-2012,BUL-2012(G1): About 10 hours (25 °C, no alarm, no lighting, and battery fully charged [normal mode]) BUL-2012,BUL-2012(G1): About 4 hours (25 °C, no alarm, no lighting, and battery fully charged [leak check mode])			
Operating temperature	-20 - +50 °C			
Operating humidity	Below 95 %RH (Non-condensing)			
Structure	Drip-proof and dust-proof performances (compliant to IP67 level)			
Explosion-proof structure	Intrinsically safe explosion-proof structure			
Explosion-proof class	ATEX/UKEX II 1G Ex ia II C T4 Ga (without combustible LEL gas sensor) II 1G Ex ia II B T4 Ga (with combustible LEL gas sensor) IECEX Ex ia II C T4 Ga (without combustible LEL gas sensor) Ex ia II B T4 Ga (with combustible LEL gas sensor)			
Dimension	Approx. 71 (W) × 173 (H) × 43 (D) mm (projection portions excluded)			
Weight	Approx. 360 g (When BUD-2012 is used)/Approx. 360 g (When BUL-2012,BUL-2012(G1) are used)			

\* Specifications subject to changes without notice.

\* Detection of high-concentration combustible gases (vol%) is only possible with CH<sub>4</sub> specification type.**Combination of Detectable Gases by Type**

	Oxygen (O <sub>2</sub> )	Combustible gas (HC or CH <sub>4</sub> )	Combustible gas (CH <sub>4</sub> )	Combustible gas (HC or CH <sub>4</sub> )	Carbon monoxide (CO)
	0 - 25 vol% <Up to 40 vol%>	0 - 100 %LEL	0 - 100 %LEL	0 - 500 ppm (HC) <510 - 2000 ppm>(HC) 0 - 2000 ppm (CH <sub>4</sub> ) <2010 - 5000 ppm> (CH <sub>4</sub> )	0 - 150 ppm <Up to 500 ppm>
Type A	●	●	●	●	●
Type B	●	●	-	●	●
Type C	●	●	●	●	-
Type D	●	●	-	●	-

## 9-2. List of accessories

Standard accessories	<ul style="list-style-type: none"> <li>• Dry battery unit (BUD-2012)</li> <li>• Alkaline dry batteries: 3</li> <li>• Taper nozzle: 1</li> <li>• Hand strap: 1</li> <li>• Operating manual</li> <li>• Product warranty</li> </ul>
Optional accessories	<ul style="list-style-type: none"> <li>• Float probe</li> <li>• H<sub>2</sub>S sensor filter (humidity control filter)</li> <li>• Teflon filter</li> <li>• Wire mesh filter</li> <li>• HC-LEL sensor filter (hydrogen sulfide scrubber filter)</li> <li>• CO sensor filter (activated carbon filter)</li> <li>• Charger</li> <li>• Lithium ion battery unit (BUL-2012,BUL-2012(G1))</li> <li>• Silica gel filter</li> <li>• Belt clip</li> <li>• Data logger management program</li> </ul>

---

# 10

---

## Definition of Terms

vol%	Gas concentration indicated in the unit of one-hundredth of the volume
ppm	Gas concentration indicated in the unit of one-millionth of the volume
LEL	An abbreviation for "Lower Explosion Limit." LEL refers to the lowest concentration of a combustible gas in air capable of causing explosion when ignited.
TWA	An abbreviation for "Threshold Limit Value Time Weighted Average Limit." TWA refers to a concentration limit of toxic substances as a time weighted average to which repetitious exposure of almost all the workers in 8-hour work shift or a 40-hour work week does not have harmful effects on their health.
STEL	An abbreviation for "Threshold Limit Value Short Term Exposure Limit." STEL refers to a concentration limit of toxic substances to which everyday exposure of workers for 15 continuous minutes lower than TWA does not have harmful effects on their health.



# EU-Declaration of Conformity

Document No.: 320CE22095



We, RIKEN KEIKI Co., Ltd. 2-7-6, Azusawa, Itabashi-ku, Tokyo, 174-8744 Japan declare under our sole responsibility that the following product conforms to all the relevant provisions.

Product Name: Portable Multi-Gas Monitor  
Model: GX-2012, GX-2012GT

Council Directives		Applicable Standards
2014/30/EU	EMC Directive	EN 50270:2015
2014/34/EU	ATEX Directive	EN IEC 60079-0:2018 EN 60079-11:2012
2011/65/EU <sup>[1]</sup>	RoHS Directive	EN IEC 63000:2018

<sup>[1]</sup>Including substances added by Commission Delegated Directive (EU) 2015/863

EU-Type examination Certificate No. DEKRA 11ATEX0123

Notified Body for ATEX DEKRA Certification B.V. (NB 0344)  
Meander 1051, 6825 MJ Arnhem  
P.O.Box 5185,6802 ED Arnhem  
The Netherlands

Auditing Organization for ATEX DNV Product Assurance AS (NB 2460)  
Veritasveien 1  
1363 Høvik  
Norway

The marking of the product shall include the following:

 II 1 G Ex ia IIC/IIB T4 Ga

Alternative Marking: - IIC:without thermocatalytic gas sensor  
- IIB:with thermocatalytic gas sensor

Place: Tokyo, Japan

Date: Jun. 29, 2022

Takakura Toshiyuki  
General manager  
Quality Control Center



# EU-Declaration of Conformity

Document No.: 320CE22099



We, RIKEN KEIKI Co., Ltd. 2-7-6, Azusawa, Itabashi-ku, Tokyo, 174-8744 Japan declare under our sole responsibility that the following product conforms to all the relevant provisions.

Product Name: Battery Charger  
Model: BC-2012

Council Directives		Applicable Standards
2014/30/EU	EMC Directive	EN 50270:2015
2011/65/EU <sup>[1]</sup>	RoHS Directive	EN IEC 63000:2018

<sup>[1]</sup>Including substances added by Commission Delegated Directive (EU) 2015/863

Place: Tokyo, Japan

Date: Jun. 29, 2022

Takakura Toshiyuki  
General manager  
Quality Control Center



# UK-Declaration of Conformity

Document No. 320UK23018



We, RIKEN KEIKI Co., Ltd. 2-7-6, Azusawa, Itabashi-ku, Tokyo, 174-8744, Japan declare under our sole responsibility that the following product conforms to all the relevant provisions.

Product Name Portable Multi-Gas Monitor  
Model GX-2012, GX-2012GT

Regulations	UK designated Standards
Electromagnetic Compatibility Regulations 2016 (S.I. 2016/1091)	BS EN 50270:2015
The Equipment and Protective Systems Intended for Use in Potentially Explosive Atmospheres Regulations 2016 (S.I. 2016/1107) (UKEX)	BS EN IEC 60079-0:2018 BS EN 60079-11:2012
The Restriction of the Use of Certain Hazardous Substances in Electrical and Electronic Equipment Regulations 2012 (S.I. 2012/3032)	BS EN IEC 63000:2018

UK-Type examination Certificate No.

DEKRA 21UKEX0364

Approved Body for UKEX

DEKRA Certification UK Ltd (AB8505)  
Stokenchurch House, Oxford Road,  
Stokenchurch, Buckinghamshire HP14 3SX,  
United Kingdom

Auditing Organization for UKEX

DNV Business Assurance UK Ltd (AB8501)  
4th Floor Vivo Building, 30 Stamford Street,  
London SE1 9LQ, United Kingdom

The marking of the product shall include the following



II 1 G Ex ia IIC/IIB T4 Ga

Alternative Marking

- IIC:without thermocatalytic gas sensor
- IIB:with thermocatalytic gas sensor

Place: Tokyo, Japan

Date: Aug. 31, 2023

Takakura Toshiyuki  
General manager  
Quality Control Center



# UK-Declaration of Conformity

Document No.: 320UK22066



We, RIKEN KEIKI Co., Ltd. 2-7-6, Azusawa, Itabashi-ku, Tokyo, 174-8744 Japan declare under our sole responsibility that the following product conforms to all the relevant provisions.

Product Name: Battery Charger  
Model: BC-2012

Regulations	UK designated Standards
Electromagnetic Compatibility Regulations 2016 (S.I. 2016/1091)	BS EN 50270:2015
The Restriction of the Use of Certain Hazardous Substances in Electrical and Electronic Equipment Regulations 2012 (S.I. 2012/3032)	BS EN IEC 63000:2018

Place: Tokyo, Japan

Date: May. 27, 2022

---

Takakura Toshiyuki  
General manager  
Quality Control Center