



PT0E-20514

**Portable Gas Monitor
GX-3R Pro
(MED specification)
Operating Manual
(PT0-165)**

RIKEN KEIKI Co., Ltd.

2-7-6 Azusawa, Itabashi-ku, Tokyo, 174-8744, Japan

Phone : +81-3-3966-1113

Fax : +81-3-3558-9110

E-mail : intdept@rikenkeiki.co.jp

Web site : <https://www.rikenkeiki.co.jp/english/>

Contents

1 Product Overview	5
1-1. Introduction	5
1-2. Intended use	5
1-3. Checking the detection target gases	6
1-4. DANGER, WARNING, CAUTION, and NOTE	7
1-5. Checking standards and explosion-proof specifications	7
2 Important Safety Information	8
2-1. Danger information	8
2-2. Warning information	9
2-3. Caution information	10
2-4. Safety information	12
3 Product Configuration	15
3-1. Main unit and standard accessories	15
Main unit	15
Standard accessories	16
3-2. Part names and functions	17
Main unit	17
Battery unit	18
LCD display	19
4 Alarm Activation	20
4-1. Gas alarm activation	20
4-2. Fault alarm activation	23
4-3. Panic alarm	24
Panic alarm buzzer sounding and lamp flashing patterns	24
Panic alarm activation and alarm pattern	24
4-4. Man down alarm	25
Man down alarm buzzer sounding and lamp flashing patterns	25
Man down alarm display and alarm patterns	25
5 Usage Instructions	26
5-1. Before using the product	26
5-2. Preparing startup	26
5-2-1. Charging and attaching the lithium ion battery unit (BUL-3R)	26
5-3. Startup	29
Turning on the power	29
Screen transition from powering on to displaying measurement screen	30
5-4. Air calibration	33
Air calibration procedure	33
5-5. Gas detection	35
5-5-1. Basic operating procedures	36
5-5-2. Measurement mode	37
5-6. Turning off the power	39
6 Setting Procedure	40
6-1. Display mode	40
6-1-1. Displaying display mode	40
6-1-2. Display mode display details	40
6-2. Display mode settings	43
6-2-1. Clearing PEAK value display	43
6-2-2. Combustible gas conversion setting	44
6-2-3. Long-life battery setting	46
6-2-4. Calibration data display	47
6-2-5. Bump data display	48
6-2-6. Alarm setpoint display	49
6-2-7. LCD inversion setting	50

6-2-8. LCD background setting	51
6-2-9. Bluetooth setting	51
6-2-10. Buzzer volume adjustment	52
6-2-11. Display language setting	52
6-3. User mode	54
6-3-1. Displaying user mode	54
6-3-2. User mode settings	55
6-4. User mode settings	56
6-4-1. Bump test	56
6-4-2. Calibration	56
6-4-3. Calibration expiration date setting	56
6-4-4. Bump test setting	60
6-4-5. Man down alarm setting	66
6-4-6. Alarm setpoint setting	68
6-4-7. Lunch break: ON/OFF	71
6-4-8. Confirmation beep setting	71
6-4-9. Automatic backlight: ON/OFF	74
6-4-10. Backlight lighting time setting	74
6-4-11. Key tone: ON/OFF	75
6-4-12. Display mode item display: ON/OFF	75
6-4-13. CO ₂ sensor unit selection	76
6-4-14. CO ₂ sensor air calibration: ON/OFF	76
6-4-15. Date and time setting	77
6-4-16. Date format setting	77
6-4-17. Language setting	78
6-4-18. User password setting	79
6-4-19. ROM/SUM display	80
6-4-20. Bluetooth authentication display	80
7 Maintenance	81
7-1. Maintenance intervals and maintenance items	81
Maintenance service	82
7-2. Calibration	83
7-2-1. Preparation for calibration	83
7-2-2. Calibration setting menu	86
7-2-3. Air calibration	87
7-2-4. CO ₂ zero calibration	89
7-2-5. Auto calibration	90
7-2-6. Switch from AUTO calibration to measurement start screen	91
7-2-7. Auto calibration cylinder setting	92
7-2-8. Auto calibration gas concentration selection	93
7-3. Bump test	94
7-3-1. Perform bump test (BUMP TEST)	94
7-3-2. Switching from bump test (BUMP TEST) to measurement start screen	96
7-5. Parts replacement	97
7-5-1. Periodic replacement parts	97
7-5-2. Filter replacement	99
8 Storage and Disposal	101
8-1. Procedures for storage or when not in use for extended periods	101
8-2. Procedures for use after storage	102
8-3. Product disposal	102
9 Troubleshooting	103
9-1. Product abnormalities	103
9-2. Reading abnormalities	105
10 Product Specifications	106
10-1. Specifications list	106
10-2. Accessory list	112

11 Appendix	113
Data logger function	113
100 %LEL = ppm conversion list.....	115
Radio Law Certification	116
Limited Warranty and Limitation Liability	120

1

Product Overview

1-1. Introduction

Thank you for your purchase of the GX-3R Pro MED specification Portable Gas Monitor (“product” hereinafter). First, confirm that the model number of the product you purchased matches the model number of the product covered by this manual.

The product should be used only by fully-trained personnel.

The maintenance procedures described in this manual should be performed only by fully-trained personnel. Any maintenance procedure not described in this manual must be performed by RIKEN KEIKI or our certified service engineers. Please contact RIKEN KEIKI.

This manual describes how to use the product and provides product specifications. Make sure you have read and fully understand the contents of this manual before using the product. This applies both to first-time users and those who have previously used the product. Keep this manual in a safe place for future reference.

The contents of this manual are subject to change without notice to allow product improvements. Any duplication or reproduction of this manual without permission is prohibited, whether in whole or in part.

In addition to this manual, manuals are also provided for optional products (sold separately). Refer to the following manuals along with this manual when using optional products (sold separately):

- 1) RP-3R Pump Unit Operating Manual (PT0E-166)
- 2) SW-GX-3R Data Logger Management Program Software Operating Manual (PT0E-178)
- 3) SDM-3R Docking Station Operating Manual (PT0E-167)

Regardless of the warranty period, RIKEN KEIKI does not accept any liability for accidents or damage resulting from use of the product.

Be sure to read the warranty policy set forth on the warranty.

1-2. Intended use

The product is a multi-gas monitor equipped with up to four types of sensors to enable detection of five different gas types using a single unit.

The detection target gases vary depending on the particular sensors installed in the product. Check the detection target gases before use to confirm the correct gases will be detected in accordance with the intended purpose.

The product is a gas detector designed to measure the concentrations of chemicals in the air in working environments. It measures concentrations of toxic gases, combustible gases, and oxygen in the air and issues an alarm if concentrations exceed preset levels, thereby alerting users to the hazards of gas poisoning and oxygen deficiency.

1-3. Checking the detection target gases

The combination of detection target gases will vary depending on the particular sensors installed in the product.

Check the detection target gases on the nameplate attached to the rear of the product before use.

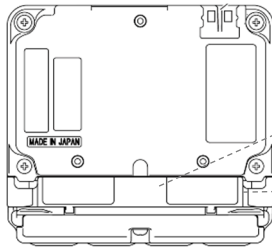

Rear

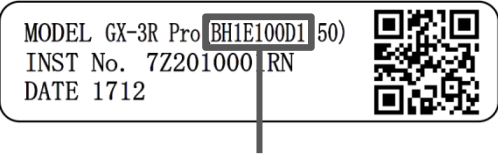

The detection target gases can be checked via the product code.

B ○ ○ ○ ○ ○ ○ ○ ○
 (Fixed) ① ② ③ ④ ⑤ ⑥ ⑦ ⑧

<Sensor>

Position	Spec.	Sensor model	Symbol
①	Combustible gas (HC or CH ₄) sensor	NCR-6309	H: Installed (HC)
		NCR-6309	M: Installed (CH ₄)
		-	0: Not installed
②	Oxygen (O ₂) sensor	ESR-X13P	1: Installed 0: Not installed
③④	Carbon monoxide/hydrogen sulfide (CO/H ₂ S) sensor	ESR-A1DP	E1
	Carbon monoxide (CO) sensor*	ESR-A1CP	E2
	Sulfur dioxide (SO ₂) sensor	ESR-A13D	E3
	Hydrogen sulfide (H ₂ S) sensor	ESR-A13i	E4
	Carbon monoxide (CO) sensor	ESR-A13P	E5
	Hydrogen cyanide (HCN) sensor	ESR-A13D	E7
⑤⑥	Sulfur dioxide (SO ₂) sensor	ESR-A13D	E3
	Hydrogen sulfide (H ₂ S) sensor	ESR-A13i	E4
	Nitrogen dioxide (NO ₂) sensor	ESR-A13D	E6
	Hydrogen cyanide (HCN) sensor	ESR-A13D	E7
	Phosphine (PH ₃) sensor	ESR-A13D2	E8
	Ammonia (NH ₃) sensor	ESR-B134	E9
	Carbon dioxide (CO ₂) <vol%> sensor	IRR-0409	D1
	Carbon dioxide (CO ₂) <ppm> sensor	IRR-0433	D2
	-	-	00

<Battery unit>

Position	Spec.	Battery unit model	Symbol
⑦	Lithium ion battery	BUL-3R	L



<BLE function>

Position	Spec.	Symbol
⑧	BLE supported	1
	BLE unsupported	0

* The carbon monoxide sensor (ESR-A1CP) includes a correction function to reduce interference due to hydrogen. This function works for hydrogen concentrations up to 2,000 ppm. (However, if used in an environment exceeding 40°C for more than 15 minutes, it may be affected by hydrogen interference and may indicate a higher carbon monoxide concentration than actual.)

1-4. DANGER, WARNING, CAUTION, and NOTE

This manual uses the following headings to ensure safe and effective work:

 DANGER	This indicates situations in which improper handling may result in fatal or serious injury to persons or serious damage to property.
 WARNING	This indicates situations in which improper handling may result in serious injury to persons or serious damage to property.
 CAUTION	This indicates situations in which improper handling may result in minor injury to persons or minor damage to property.
NOTE	This indicates handling tips.

1-5. Checking standards and explosion-proof specifications

The product specifications will vary depending on the specific standards and explosion-proof certification. Check the actual product specifications before use.

Check the affixed nameplate for product specifications.

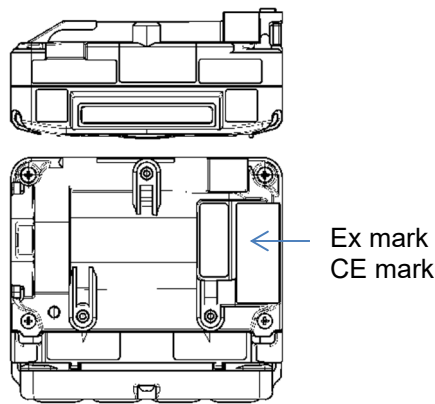

ATEX/IECEX,CE marking
type name plate

2

Important Safety Information

To maintain the performance of the product and to ensure safe use, always observe the following DANGER, WARNING, and CAUTION instructions.

2-1. Danger information



DANGER

Explosion-proofing

- Do not modify or alter the circuitry or configuration.

Usage

- If measuring inside manholes or enclosed spaces, never lean over or look into the manhole or enclosed space. There is a danger that oxygen-deficient air or other gases may be discharged from such locations.

2-2. Warning information



WARNING

If an abnormality is discovered in the product

- If an abnormality is discovered in the product, contact RIKEN KEIKI immediately. Visit our website for information on the nearest RIKEN KEIKI office.
Website: <https://www.rikenkeiki.co.jp/>

-

Sensor handling

- Do not attempt to disassemble the electrochemical type sensor inside the product. Electrolyte contained inside may cause inflammation if it comes into contact with the skin. There is also a risk of blindness if it comes into contact with the eyes. Electrolyte may discolor or decompose clothing if it comes into contact with clothing. If contact occurs, rinse the area immediately with plenty of water. Do not use any gas other than nitrogen as the balance gas when calibrating or adjusting an oxygen sensor.

Fresh air adjustment in the atmosphere

- When fresh air adjustment is performed in the atmosphere, check the atmosphere for freshness before starting. The presence of interference gases will make it impossible to adjust the product correctly, resulting in the danger of erroneous detection when actual gas leaks occur.

Action when a gas alarm occurs

- When a gas alarm occurs, this indicates an extremely dangerous situation. The user must take appropriate action after taking steps to ensure safety.

Panic alarm and man down alarm

- The panic and man down alarms are intended to assist the user and those in the vicinity to make appropriate decisions. They are not intended to assure life or safety. Do not depend solely on this function when using the product.
(The man down alarm is normally disabled and unavailable. To use this function, change the product setting.)
- If a panic or man down alarm is triggered, those in the vicinity must take appropriate action after assessing the situation.

Battery level check

- Check battery levels before using the product. The batteries may be depleted when the product is used for the first time or after extended periods without use. Replace the batteries with new ones before use.
- If a low battery voltage alarm occurs, gas cannot be detected. If the alarm is issued during use, turn off the power and promptly charge or replace the batteries in a safe place.

Miscellaneous

- Gas cannot be detected if the sensor is covered with water such as rainwater. Do not use the product in rain or submerge it in water.
- When wearing the product, make sure that it is exposed to the air. If it is covered or blocked, correct measurement cannot be obtained, possibly resulting in accidents.
- Do not dispose of the product into fire.
- Do not attempt to wash the product, either in a washing machine or an ultrasonic cleaning machine.
- Do not block the buzzer sound opening. Doing so will muffle or silence the audible warning.
- Do not remove the battery unit while the power is turned on.
- The product is a personal gas monitor to be worn on the body. Therefore, before using the product in a confined space, suspend it with a separately prepared rope, tie it to the end of a rod or connect the suction pump unit RP-3R (sold separately) to detect the atmosphere from the outside of the confined space to confirm safety in advance.
- While conducting measurement in a confined space, do not lean over or look into the closed space. It may lead to dangers because oxygen-deficient air or other gases may blow out.

2-3. Caution information



CAUTION

- Do not use the product in locations where it may be exposed to oil or chemicals, etc.
 - Avoid using the product in locations where the product may be splashed with liquids such as oil and chemicals.
 - Do not place the product in locations where water or dirt accumulates. Placing the product in such locations may cause malfunction due to water or dirt ingress into the buzzer sound opening, etc.
- Do not use the product in locations where the temperature exceeds the range of operating temperatures.
 - The operating temperature range for the product is as follows. Avoid using the product at temperatures outside the operating range.
 - Other than HCN, NH₃:
 - Continuous use environment: -20 °C to +50 °C
 - Temporary use environment: -40 °C to +60 °C
 - HCN:
 - Continuous use environment: -20 °C to +50 °C
 - Temporary use environment: -20 °C to +60 °C
 - NH₃:
 - Continuous use environment: -20 °C to +50 °C
 - Temporary use environment: -30 °C to +50 °C
 - Avoid using the product for extended periods in locations where it is exposed to direct sunlight.
 - Avoid storing the product inside parked vehicles in hot weather.
- Adhere to the operating humidity range to prevent condensation forming inside the product. Condensation forming inside the product may cause clogging or gas adsorption, which may prevent accurate gas detection. Condensation must be avoided at all costs. In addition to the usage environment, carefully monitor the temperature and humidity of the sampling point to prevent condensation forming inside the product.
- Do not use walkie-talkies near the product.
 - Radio waves from walkie-talkies or other radio wave transmitting devices near the product may affect readings. If walkie-talkies or other radio wave transmitting devices are used, these must be used away from the product where they do not affect operation.
 - Do not use the product near devices that emit strong electromagnetic radiation (high-frequency or high-voltage devices).
- Verify that the operation status display is blinking before using the product.
If the operation status display is not blinking, gas cannot be detected properly.



CAUTION

- Be sure to perform regular maintenance.
The product must be maintained regularly to ensure safety. Continuing to use the product without maintaining it will result in sensor sensitivity variations, preventing accurate gas detection.
- Miscellaneous
 - Pressing buttons unnecessarily may change the settings, preventing alarms from activating correctly. Avoid performing any operations not described in this operating manual.
 - Do not drop the product or subject it to impact. Doing so may degrade explosion-proof, waterproof, dustproof, and gas detection performance.
 - Do not use the product while charging it.
- Do not poke the buzzer or sensor openings with sharp-pointed items. Doing so may result in ingress of water or foreign matter, resulting in malfunctions or damage to the product.
- Do not block the buzzer sound opening with tape or other objects. This will prevent adjustment of the internal pressure of the product, which may result in malfunctions.
- Do not remove the panel sheet on the LCD display. Doing so will impair waterproof and dustproof performance.
- Do not cover the infrared port with labels or any other objects. This will prevent infrared communication.
- Usage
 - The operating time will be reduced due to battery performance in cold environments.
 - The response of the LCD display may slow at low temperatures.
 - Always perform air calibration under conditions of pressure, temperature, and humidity similar to those in the operating environment and in fresh air.
 - Wait for the readout to stabilize before performing air calibration.
 - If there is a temperature difference of 15 °C or more between the storage and usage locations, turn on the power and allow the product to stand and acclimatize for about 10 minutes (about 30 minutes if the product is equipped with an ammonia (NH₃) sensor) in an environment similar to the usage location before performing air calibration in fresh air.
 - When an ammonia (NH₃) sensor is installed, the indication may rise temporarily immediately after the sensor is energized due to its characteristics. When replacing the battery before it runs out, please wait at least 10 minutes before turning the power back on. Also, when the sensor is replaced, the battery is replaced because it is dead, or the battery is removed and has not been used for a long period of time, turn the power back on after 120 minutes or more.
 - When wiping the product clean, do not splash water on it or use organic solvents like alcohol or benzene. Doing so may discolor or damage the surfaces of the product.
 - If the product will not be used for extended periods, install new batteries before storing. Replace the batteries every six months. Battery leaks may result in fire or injury.
 - After a period of extended storage, be sure to perform calibration before resuming use. For information on readjustment including calibration, please contact RIKEN KEIKI.

Sensors

- Note that if combustible gas sensors are used in an environment where silicone compounds, halides, high concentrations of sulfides, or high concentrations of solvent gases are present, sensor life may be reduced, sensitivity to combustible gases may deteriorate, and accurate readings may not be obtained. If use in such environments is unavoidable, use for the shortest possible time and allow the product to stand in fresh air after use. Confirm that the reading returns to normal and is stabilized.
- An oxygen concentration higher than a certain level is required in order for the combustible gas sensor <%LEL> in the product to correctly detect gases and display concentrations.
- Do not expose the product to sudden pressure fluctuations. Oxygen readings will vary temporarily, preventing accurate measurement.
- Do not use any gas other than nitrogen as the balance gas when calibrating or adjusting an oxygen sensor. Otherwise, oxygen reading errors will increase, preventing accurate measurement.
- When equipped with a carbon dioxide (CO₂) sensor, it may show a high indication immediately after energization due to the characteristics of the sensor
You Warm it up for about 10 to 20 minutes and use it after instructions are stable.

2-4. Safety information

Necessary information for explosion proof construction of Model GX-3R Pro.

Overview

The GX-3R Pro can measure up to 5 gases using 4 sensors.

The GX-3R Pro measures the combustible gases (LEL), oxygen (O₂), hydrogen sulfide (H₂S), and carbon monoxide (CO).

The GX-3R Pro can additionally measure toxic gases including carbon and sulfur dioxides (CO₂ and SO₂).

This model displays measurement results on an LCD and issue gas alarms (via LED and buzzer) as needed. This model also wirelessly transmits measurement results to a host using Bluetooth.

Gas sampling is by diffusion. The models do not have internal suction pumps.

Power sources

The GX-3R Pro draws power from either a Li-ion battery unit (BUL-3R), which has integral components for maintaining intrinsic safety.

These battery units are user-replaceable in non-hazardous areas.

A dedicated AC adapter is used for recharging the Li-ion battery.

<ATEX/IECEX specification>

Explosion proof structure	Intrinsically safe explosion-proof construction and flame-proof enclosures		
Specification for safety	Ex da ia I Ma , Ex da ia IIC T4 Ga (with combustible gas sensor NCR-6309) Ex ia I Ma , Ex ia IIC T4 Ga (without combustible gas sensor NCR-6309)		
	 I M1 Ex da ia I Ma, II 1 G Ex da ia IIC T4 Ga (with combustible gas sensor NCR-6309) I M1 Ex ia I Ma, II 1 G Ex ia IIC T4 Ga (without combustible gas sensor NCR-6309)		
Ambient temperature range	-40°C to +60°C		
Ambient temperature range (for charging)	0°C to +40°C		
Electrical data	<ul style="list-style-type: none"> • Lithium-ion battery: Maxell rechargeable battery model no. ICP463048XS or Panasonic rechargeable battery model no. UF463048F. • The battery should be charged with the dedicated AC adapter or by power from a IEC60950-certified SELV power source, or IEC62368-1-certified ES1 power source. The maximum voltage from the charger shall not exceed 6.3Vdc. 		
Certificate numbers	<ul style="list-style-type: none"> • IECEX : IECEX DEK 17.0050 X • ATEX : DEKRA 17 ATEX 0103 X 		
List of standards	<table border="0" style="border-collapse: collapse;"> <tr> <td style="border-right: 1px solid black; padding-right: 10px;"> <ul style="list-style-type: none"> • IEC 60079-0:2017 • IEC 60079-1:2014-06 • IEC 60079-11:2011 </td> <td style="padding-left: 10px;"> <ul style="list-style-type: none"> • EN IEC 60079-0:2018 • EN60079-1:2014 • EN60079-11:2012 • EN50303:2000 </td> </tr> </table>	<ul style="list-style-type: none"> • IEC 60079-0:2017 • IEC 60079-1:2014-06 • IEC 60079-11:2011 	<ul style="list-style-type: none"> • EN IEC 60079-0:2018 • EN60079-1:2014 • EN60079-11:2012 • EN50303:2000
<ul style="list-style-type: none"> • IEC 60079-0:2017 • IEC 60079-1:2014-06 • IEC 60079-11:2011 	<ul style="list-style-type: none"> • EN IEC 60079-0:2018 • EN60079-1:2014 • EN60079-11:2012 • EN50303:2000 		

SPECIFIC CONDITIONS OF USE

When the portable gas monitor is equipped with thermo catalytic gas sensor model NCR-6309 in type of protection Ex da:

- The sensor model NCR-6309 is tested with low risk of mechanical danger for use in a Group I environment, therefore it shall be protected against high impact energy.
- The Sensor model NCR-6309 shall not be exposed to ultraviolet light or used in equipment in which it is not fully enclosed.
- The Sensor model NCR-6309 is a flameproof product and is not to be disassembled or modified with the exception of specified parts.
- The equipment shall not be exposed to oil or hydraulic fluid.



WARNING

- Do not attempt to disassemble or modify the instrument.
- The combustible gas sensor NCR-6309, to measure LEL, is the only part of this Gas Monitor system with flame - proof construction.
- This product is an explosion-proof product and is not to be disassembled or modified with the exception of specified parts.
- NCR-6309 must not be exposed to ultraviolet light.
- This product integrates a sensor having flameproof construction. If assembly is not performed as specified, explosion protection performance will be compromised. When replacing the sensor and filter, properly install genuine parts and torque to specification.
- If the enclosure is damaged it shall be repaired before further use.
- The Sensor shall not be exposed to ultraviolet light or used in equipment in which it is not fully enclosed.
- Do not charge in a hazardous location.
- Do not charge the unit with a non-genuine charger.
- Do not replace battery unit in a hazardous location.

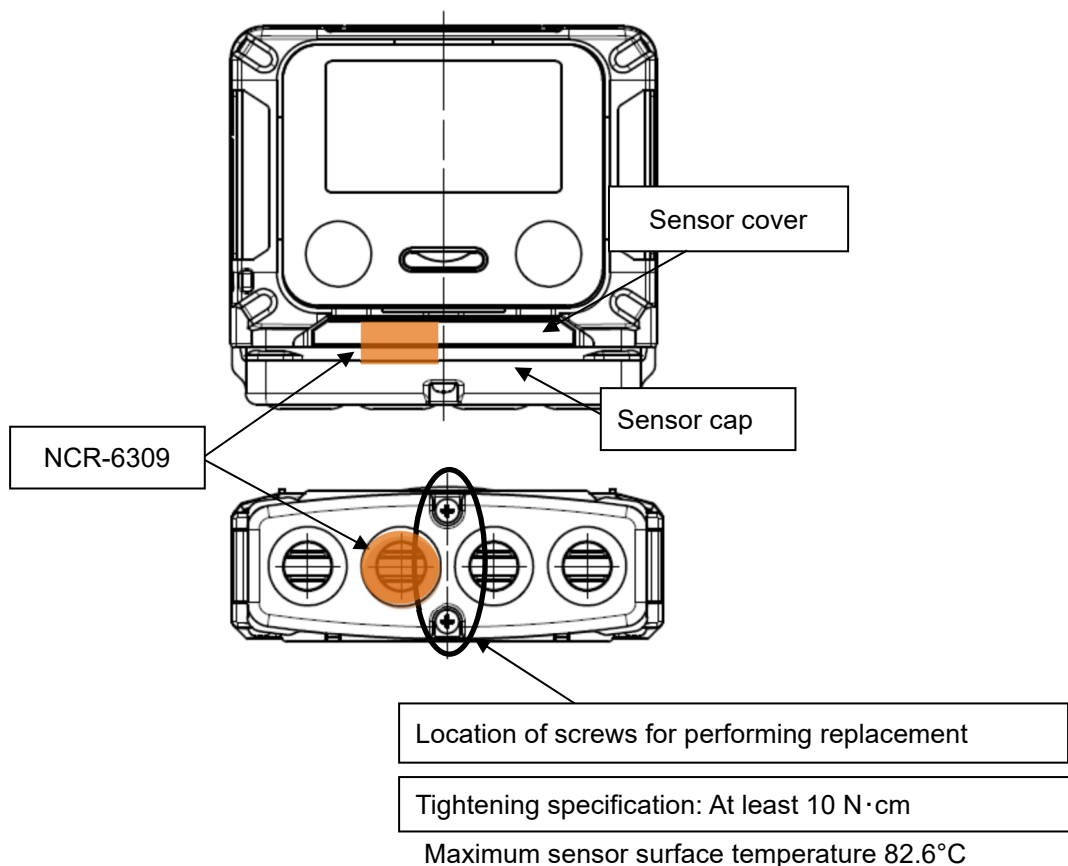

Instruments No.

INST. No. 00 0 000 0000 00
 A B C D E

- A: Year of manufacture (0 to 9)
- B: Month of manufacture (1 to 9 for Jan.-Sep.; XYZ for Oct., Nov., Dec.)
- C: Manufacturing lot
- D: Serial number
- E: Factory codes



RIKEN KEIKI Co., Ltd.
2-7-6 Azusawa, Itabashi-ku, Tokyo, 174-8744, Japan
Phone: +81-3-3966-1113
Fax: +81-3-3558-9110
E-mail: intdept@rikenkeiki.co.jp
Website: <https://www.rikenkeiki.co.jp>

3

Product Configuration

3-1. Main unit and standard accessories

Unpack and check the product and accessories.
If anything is missing, contact RIKEN KEIKI.

Main unit

For detailed information on the names and functions of the product parts and the LCD display, see “3-2. Part names and functions” on page 17.



GX-3R Pro main unit

Standard accessories

Lithium ion
battery unit
(BUL-3R)
×1

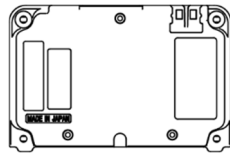

Charger
×1

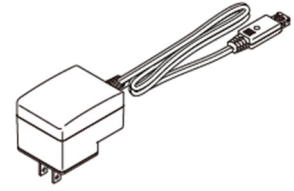

Rubber protection
cover
×1

Protects the product
from impact if it is hit by
something or dropped.

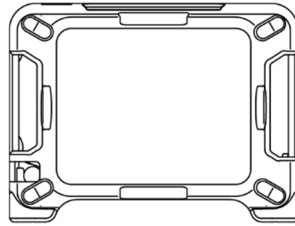

Hand strap
×1



Alligator clip
×1

Used when attaching
the product to a pocket
* ATEX/IECEX specification
only

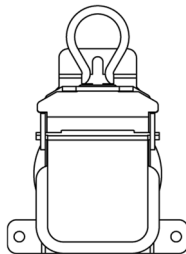

Calibration adapter
(simple type)
×1

Used to perform gas
calibration and bump
test.
* ATEX/IECEX
specification only

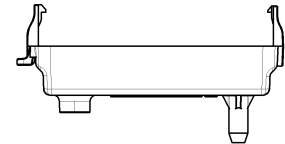

3-2. Part names and functions

This section describes the names and functions of the various parts of the main unit and the battery unit. It also describes the LCD display.

Main unit

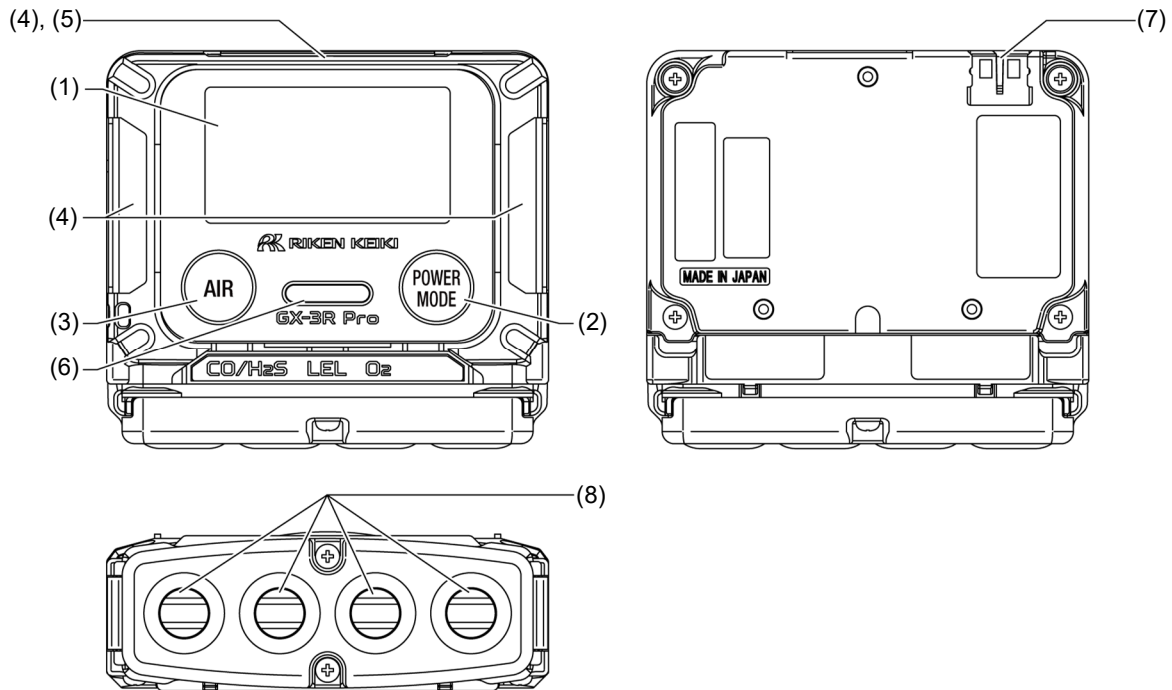

Name	Main function
(1) LCD display	Displays information such as gas type and gas concentration.
(2) POWER/MODE button	Turns power on and off. This button is also used to confirm settings in setting mode.
(3) AIR button	Performs air calibration in measurement mode. This button is also used to select settings in setting mode.
(4) Alarm LED arrays	The lamps flash red if an alarm occurs.
(5) Infrared communication port	This is used for data communication with a PC when using a data logger management program.
(6) Buzzer sound opening	Emits operating and alarm sounds. (Do not block.)
(7) Battery charging contact	Contact for connecting the charger (EPU15-102-L6).
(8) Sensors	Sensors are installed for detecting individual gases.



CAUTION

- Do not poke the buzzer or sensor openings with sharp-pointed items. Doing so may result in ingress of water or foreign matter, resulting in malfunctions or damage to the product.
- Do not remove the panel sheet on the surface. This will negatively affect the waterproof and dustproof performance.
- Do not cover the infrared communication port with labels or stickers. This will prevent infrared communication.
- Do not block the buzzer sound opening with tape or other objects. This will prevent adjustment of the internal pressure of the product, which may result in malfunctions.

NOTE

- In this operating manual, buttons with multiple functions are described as follows in the operational procedures:
Example: "POWER/MODE button" is described as follows:
 - **POWER** button when turning power on and off
 - **MODE** button when confirming settings

Battery unit**<Lithium ion battery unit (BUL-3R)>**

Battery charging
contact

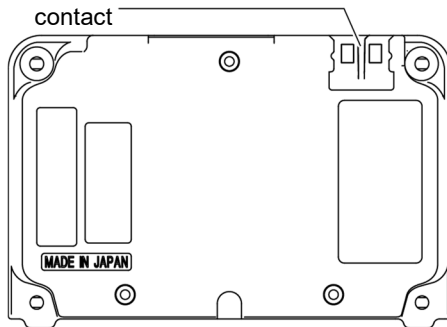

Main unit
connection
terminals

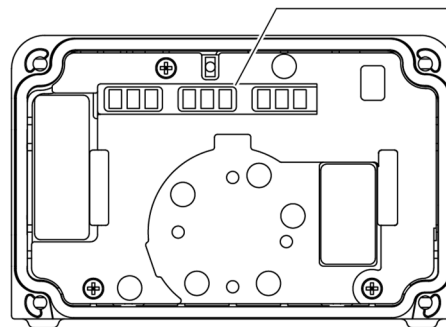

LCD display

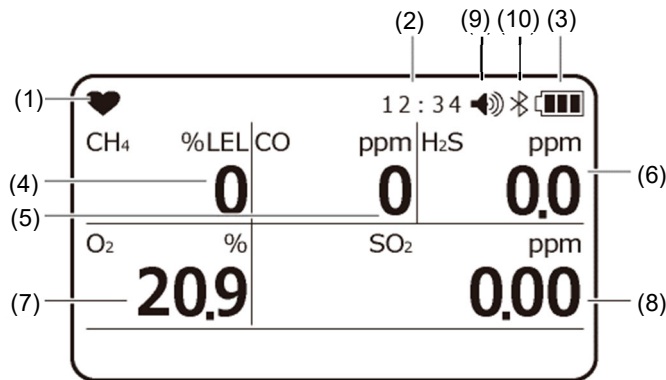

Display example

Name	Main function
(1) Operating status display	Indicates the operating status. Blinks when normal.
(2) Clock display	Displays the time.
(3) Battery level icon	Indicates battery levels. See NOTE below for a guide to battery level indications.
(4) Combustible gas concentration	Displays gas concentrations as numerical readouts. (The type of gas displayed depends on the specifications.) The concentration readout is updated each second for sensors other than the combustible gas sensor. The combustible gas concentration readout is updated every five seconds (every 15 seconds for long-life battery operation).
(5) Carbon monoxide concentration	
(6) Hydrogen sulfide concentration	
(7) Oxygen concentration	
(8) Sulfur dioxide concentration	
(9) Buzzer volume icon	Indicates the buzzer volume. See NOTE below for information on the icons displayed.
(10) Bluetooth on icon	Indicates that BLE (Bluetooth) is turned on.

NOTE

- Approximate battery levels are indicated as follows:
 - Sufficient
 - Low
 - Needs charging (replace the batteries). The battery level icon will blink if battery levels drop even further.
- The buzzer volume icon indicates "HIGH" or "LOW" as follows:
 - Volume HIGH
 - Volume LOW
- If the bump test expiration date display setting is enabled, "✓" is displayed in the upper left of the LCD until the bump test expiration date. For more information on the bump test expiration date display setting, see "6-4-4. Bump test setting" on page 60.
- If the long-life battery function is enabled, "L" is displayed in the upper left of the LCD.
- "MAINTE" is displayed on the LCD when user mode is selected.
- The Bluetooth on icon indicates the following:

Communicating:	Constantly displayed
Advertising:	Blinking at 1-second intervals
Stopped:	Not displayed

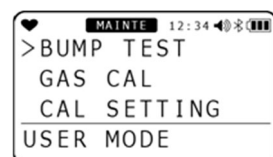
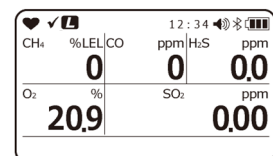

4

Alarm Activation

4-1. Gas alarm activation

<Alarm types>

A “gas alarm” is triggered if the concentration of the detected gas reaches or exceeds the alarm setpoints shown in the following table: (Self-latching)

Gas alarm types include the first alarm (WARNING), second alarm (ALARM), third alarm (ALARM H), TWA alarm, STEL alarm, OVER alarm (over scale), and M OVER alarm (minus sensor failure).

Gas alarms are prioritized as follows:

First alarm < second alarm < third alarm < M OVER alarm < OVER alarm < integrated alarm point < TWA alarm < STEL alarm

<ATEX/IECEx specifications default settings>

Item	Measured gas	Combustible gas	O ₂	CO	H ₂ S	CO ₂	
		HC or CH ₄					
Measurement range		0 to 100 %LEL	0 to 25.0 %	0 to 500 ppm	0 to 100.0 ppm	0 to 5.00 vol%	0 to 10,000 ppm
Service range		-	25.1 to 40.0 %	501 to 2,000 ppm	100.1 to 200.0 ppm	5.01 to 10.00 vol%	-
Minimum resolution		1 %LEL	0.1 %	1 ppm	0.1 ppm	0.01 vol%	20 ppm
Alarm setpoint		First alarm: 10 %LEL Second alarm: 25 %LEL Third alarm: 50 %LEL OVER: 100 %LEL M OVER alarm: -10 %LEL	L alarm: 19.5 % LL alarm: 18.0 % H alarm: 23.5 % OVER alarm: 40.0 % M OVER alarm: -1.0 vol%	First alarm: 25 ppm Second alarm: 50 ppm Third alarm: 1,200 ppm TWA alarm: 25 ppm STEL alarm: 200 ppm OVER alarm: 2,000 ppm M OVER alarm: -50 ppm	First alarm: 5.0 ppm Second alarm: 30.0 ppm Third alarm: 100.0 ppm TWA alarm: 1.0 ppm STEL alarm: 5.0 ppm OVER alarm: 200.0 ppm M OVER alarm: -10.0 ppm	First alarm: 0.50 vol% Second alarm: 3.00 vol% Third alarm: 3.00 vol% TWA alarm: 0.50 vol% STEL alarm: 3.00 vol% OVER alarm: 10.00 vol% M OVER alarm: -0.50 vol%	First alarm: 5,000 ppm Second alarm: 5,000 ppm Third alarm: 5,000 ppm TWA alarm: 5,000 ppm STEL alarm: - OVER alarm: 10,000 ppm M OVER alarm: -1,000 ppm

Item	Measured gas	SO ₂	NO ₂	HCN	PH ₃	NH ₃
Measurement range		0 to 20.00 ppm	0 to 20.00 ppm	0 to 30.0ppm	0 to 20.00 ppm	0 to 400.0 ppm
Service range		20.05 to 100.00 ppm	-	-	-	0 to 300.0 ppm
Minimum resolution		0.05 ppm	0.05ppm	0.1 ppm	0.01ppm	0.5ppm
Alarm setpoint		First alarm: 2.00 ppm Second alarm: 5.00 ppm Third alarm: 100.00 ppm TWA alarm: 2.00 ppm STEL alarm: 5.00 ppm OVER alarm: 100.00 ppm M OVER alarm: -10.00 ppm	First alarm: 2.00 ppm Second alarm: 4.00 ppm Third alarm: 20.00 ppm TWA alarm: 0.50 ppm STEL alarm: 1.00 ppm OVER alarm: 20.00 ppm M OVER alarm: -2.00 ppm	First alarm: 10.0 ppm Second alarm: 20.0 ppm Third alarm: 30.0 ppm TWA alarm: 0.9 ppm STEL alarm: 4.5 ppm OVER alarm: 30.0 ppm M OVER alarm: -3.00ppm	First alarm: 0.30 ppm Second alarm: 0.60 ppm Third alarm: 1.00 ppm TWA alarm: 0.30 ppm STEL alarm: 1.00 ppm OVER alarm: 20.00 ppm M OVER alarm: -2.00 ppm	First alarm: 25.0 ppm Second alarm: 35.0 ppm Third alarm: 35.0 ppm TWA alarm: 25.0 ppm STEL alarm: 35.0 ppm OVER alarm: 400.0 ppm M OVER alarm: -30.0 ppm

NOTE

- The default settings are as described in the table above.
- The alarm setpoints indicated for the first alarm (WARNING), second alarm (ALARM), third alarm (ALARM H), TWA alarm, and STEL alarm in the table above can be changed. For information on how to change the alarm setpoints, see “6-4-6. Alarm setpoint setting” on page 68. (For items with “-” shown, the setpoint cannot be changed.)
- M OVER alarm (minus sensor failure) alerts when the zero point dives to the minus side.
- When the alarm silence function is ON, only the buzzer sound can be stopped by pressing the MODE button while the gas alarm is being issued. If a new gas alarm is issued after the buzzer sound has stopped, the buzzer sound operation will resume. This function can be turned ON/OFF using the optional Data Logger Management SW-GX-3R.

<Gas alarm buzzer sounding and lamp flashing patterns>

If a gas alarm occurs, the user is notified by the buzzer sounding, alarm LED array flashing, and vibration, in two stages.

The individual operations are as follows:

Alarm type	First alarm	Second alarm	Third alarm	TWA alarm	STEL alarm	OVER alarm	M OVER alarm
Buzzer sounding	Repeated alternating strong and weak beeps at about 1-second intervals: “Beep, beep”	Repeated alternate strong and weak beeps at about 0.5-second intervals: “Beep, beep, beep, beep”	Repeated alternate strong and weak beeps at about 0.5-second intervals: “Beep, beep, beep, beep”	Repeated alternate strong and weak beeps at about 1-second intervals: “Beep, beep”	Repeated alternate strong and weak beeps at about 1-second intervals: “Beep, beep”	Repeated alternate strong and weak beeps at about 0.5-second intervals: “Beep, beep, beep, beep”	Repeated intermittent beeps at about 1 second intervals: “Beep, beep”
Alarm LED array flashing	Repeated flashing at about 1-second intervals	Repeated flashing at about 0.5-second intervals	Repeated flashing at about 0.5-second intervals	Repeated flashing at about 1-second intervals	Repeated flashing at about 1-second intervals	Repeated flashing at about 0.5-second intervals	Repeated flashing at about 1-second intervals
Vibration	Vibration when alarm occurs						None

For gases other than oxygen:
"Alarm Pattern (H-HH-HHH)"

For oxygen: "Alarm Pattern (L-LL-H)"

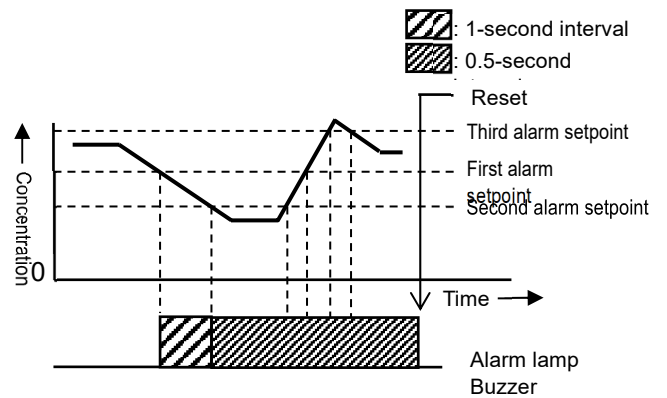
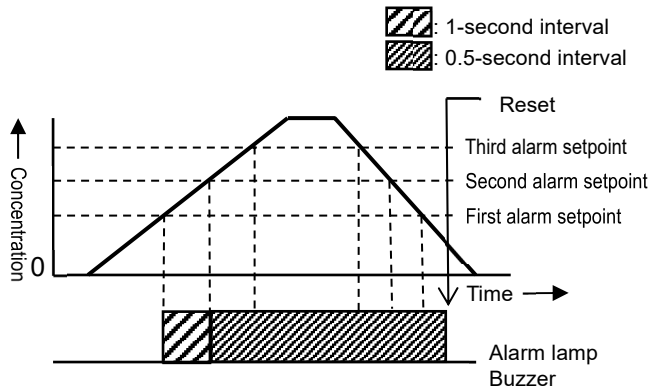

<Gas alarm display>

If a gas alarm occurs, the alarm type is indicated and the corresponding gas concentration display blinks on the LCD display.

If the detection range is exceeded (over scale), "OVER" blinks in the gas concentration display area.

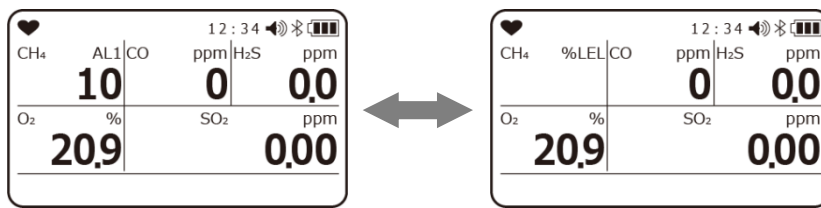

Display example
Methane (CH₄) concentration: 10 %LEL
First alarm triggered

Alarm type	First alarm	Second alarm	Third alarm	TWA alarm	STEL alarm	OVER alarm	M OVER alarm
LCD display	"AL1" appears and the gas concentration value blinks.	"AL2" appears and the gas concentration value blinks.	"AL3" appears and the gas concentration value blinks.	"TWA" appears and the gas concentration value blinks.	"STEL" appears and the gas concentration value blinks.	"OVER" appears and "OVER" blinks in the gas concentration value display area.	"M OVER" appears and "-OVER" blinks in the gas concentration value display area.



WARNING

- A gas alarm indicates the presence of extreme danger. The user must take appropriate action based on the situation.

NOTE

- Responses to an alarm can be checked using the alarm test in display mode. Note, however, that the gas concentration value will not blink in alarm tests.

4-2. Fault alarm activation

A fault alarm is triggered if an abnormality is detected in the product. (Self-latching)

Fault alarm types include system abnormalities, clock abnormalities, battery voltage abnormalities, and sensor abnormalities.

If a fault alarm occurs, the user is notified by the buzzer sounding and alarm LED array flashing.

- Buzzer sounding: Repeated intermittent beeps at about 1-second intervals “Beep-beep, beep-beep”
- Alarm LED array flashing: Repeated flashing at about 1-second intervals

The following shows typical fault alarm displays.

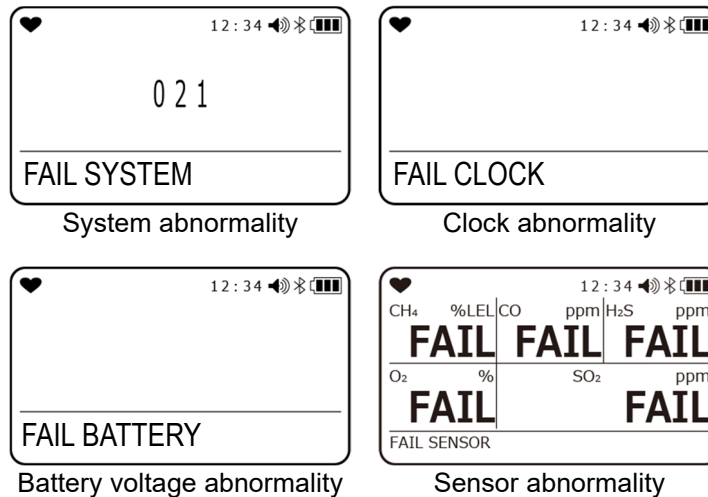

If a fault alarm occurs, determine the cause and take appropriate action.

If the problem lies with the product and the fault occurs repeatedly, contact RIKEN KEIKI immediately.

NOTE

- For more information on malfunctions (error messages), see “Troubleshooting” on page 103.

4-3. Panic alarm

A panic alarm is manually triggered by the user to notify those in the vicinity of abnormalities.



WARNING

- The panic alarm is intended to assist the user and those in the vicinity to make appropriate decisions. The detection results are not intended to assure life or safety. Do not depend solely on this function when using the product.
- Use the panic alarm appropriately after assessing the situation.

Panic alarm buzzer sounding and lamp flashing patterns

Alarm type	Prealarm	Main alarm
Buzzer sounding	Repeated intermittent beeps at about 0.5-second intervals: “Blip, blip, blip, blip”	Repeated alternate strong and weak beeps at about 1-second intervals: “Beep, beep, beep, beep”
Alarm LED array flashing	Repeated flashing at about 0.5-second intervals.	Repeated flashing at about 1-second intervals.

Panic alarm activation and alarm pattern

If you sense any abnormality, rapidly strike the product twice to trigger a panic alarm.

In case of a panic alarm, the main alarm is triggered after a 5-second prealarm.

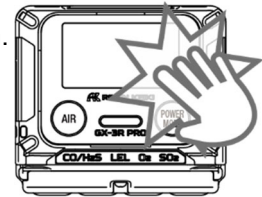

NOTE

- To stop a panic alarm prealarm or main alarm, press the **AIR** button or the **MODE** button.

4-4. Man down alarm

A man down alarm is triggered if the built-in motion sensor, which monitors the motion of the user carrying the product, detects no user motion for a certain period of time.



WARNING

- The man down alarm is intended to assist those in the vicinity of the user to make appropriate decisions. The detection results are not intended to assure life or safety. Do not depend solely on this function when using the product.
- Use the man down alarm appropriately after assessing the situation.

Man down alarm buzzer sounding and lamp flashing patterns

Alarm type	Prealarm 1	Prealarm 2	Main alarm
Buzzer sounding	Repeated intermittent beeps at about 1 second intervals: “Blip, blip”	Repeated intermittent beeps at about 0.5-second intervals: “Blip, blip, blip, blip”	Repeated alternate strong and weak beeps at about 1-second intervals: “Beep, beep, beep, beep”
Alarm LED array flashing	Repeated flashing at about 1-second intervals	Repeated flashing at about 0.5-second intervals	Repeated flashing at about 1-second intervals

Man down alarm display and alarm patterns

If no user motion has been detected for a certain period, the lamps flash and alarms are triggered while vibrating in the following sequence: prealarm 1, prealarm 2, and main alarm. When a main alarm is triggered, “MAN DOWN” appears at the bottom of the LCD screen.

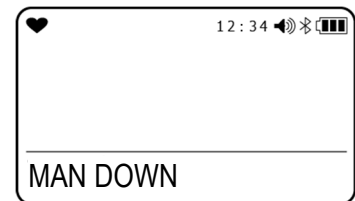

The following shows the default setting times for switching from the prealarm to the main alarm:

- Prealarm 1: 60 seconds after detection
- Prealarm 2: 75 seconds after detection
- Main alarm: 90 seconds after detection

NOTE

- The man down prealarms are stopped and measurement mode is resumed if user motion is detected.
- To stop the man down main alarm, press the **AIR** button or the **MODE** button.
- You can adjust the duration for which no user motion is detected before a man down alarm is triggered. For information on how to change the man down alarm time, see “6-4-5. Man down alarm setting” on page 66.

5

Usage Instructions

5-1. Before using the product

The operating precautions apply to both first-time users and those who have previously used the product. Ignoring these precautions may damage the product and result in inaccurate gas detection.

5-2. Preparing startup

Check the following before starting gas detection:

- Confirm that the battery level is sufficient.
- Confirm that the filter inside the product is neither contaminated nor clogged.

NOTE

- If the settings for the product were altered from an external device, be sure to confirm that the settings have been altered correctly.

5-2-1. Charging and attaching the lithium ion battery unit (BUL-3R)

Before using the product for the first time or if battery levels of the rechargeable battery in the lithium ion battery unit are low, charge using the provided charger, as described below.



DANGER

- Replace the lithium ion battery unit only in a safe place.
- Charge the battery using the provided charger in a safe place.
- Charge the battery at ambient temperatures between 0 °C and 40 °C.



CAUTION

- Be sure to turn off the power for the product before replacing the battery unit.
- Do not use the product while charging the battery. The measurements obtained will not be correct. Additionally, doing so will degrade the rechargeable battery more quickly and reduce battery life.
- The charger is neither waterproof nor dustproof. Do not charge the battery while the product is wet.
- The charger is not explosion-proof.
- After attaching the lithium ion battery unit, use screws to attach securely. If the screws are not securely tightened, the battery unit may fall off unexpectedly or water may get in through gaps.
- Avoid damaging the rubber seal.
- To maintain waterproof and dustproof performance, we recommend replacing the rubber seal every three to six years, regardless of condition.
- Always unplug the charger from the outlet when not in use.
- Do not touch the main unit connection terminals on the battery unit with bare hands. Doing so may cause contact failure.
- Do not short-circuit the connection terminals with metal objects. The battery will overheat or battery levels will drop sharply.

NOTE

- If the screws are not fully tightened, the battery unit may fall off unexpectedly or water may get in through gaps. Water may also get in if minute foreign matter is trapped beneath the battery unit.
- The lithium ion battery unit may get hot during charging. This is not an abnormality.
- The main unit will grow warmer while charging. Once charging is completed, wait at least 10 minutes before use. Using the product while still hot may result in incorrect measurements.
- When fully charged, the battery cannot be charged.
- Always unplug the charger from the outlet when not in use.
- If the battery unit is removed for extended periods, the date and time setting will be reset.
- Do not touch the main unit connection terminals on the battery unit with bare hands. There is a risk of contact failure due to contamination or damage to internal components due to static electricity.

<Charging the lithium ion battery>

- 1 Insert the DC plug of the charger into the battery charging contact of the main unit.**

Insert the DC plug cable from the top of the main unit aligning with the groove.

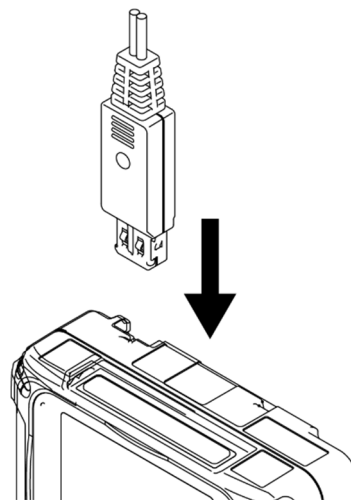

- 2 Plug the charger into the outlet.**

When the charger is connected, the charging indicator lamp lights up in green. When charging starts, the lamp lights up in orange. (Full charge requires about three hours at maximum.)

Once charging is completed, the charging indicator lamp lights up in green.

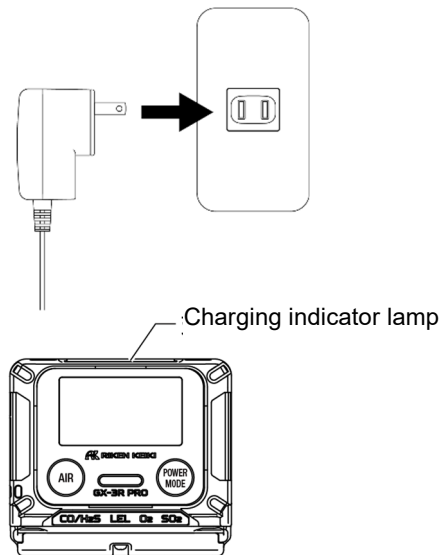

- 3 Unplug the charger from the outlet when charging is complete.**

<Removing/attaching the lithium ion battery unit>

- 1 Confirm that the power for the main unit is turned off.**

If the power is on, press the **POWER** button to turn it off.

- 2 Loosen the four screws securing the battery unit, then remove the lithium ion battery unit from the main unit.**

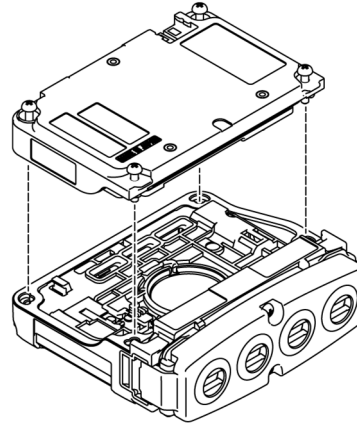

- 3 When attaching the lithium ion battery unit, secure with the four screws.**

Make sure the rubber seal is neither misaligned nor detached from the mounting surface.

The screws should be tightened with torque of 15 to 16 N·cm.

5-3. Startup

When the power is turned on, various settings including date and time and alarm setpoints are displayed, and then the measurement mode screen is displayed.

Turning on the power

Hold down the **POWER button (for at least 5 seconds) until the buzzer blips.**

The power turns on.

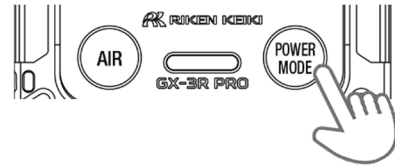

The entire LCD display lights up.



NOTE

- When the power is turned on, the LCD, lamps, and buzzer start to operate and the product vibrates. Before using the product, check that these operations function correctly.

Screen transition from powering on to displaying measurement screen

When the power is turned on, the LCD display changes automatically as shown below before the measurement screen is displayed.

<Display examples: Default settings> (about 40 seconds)

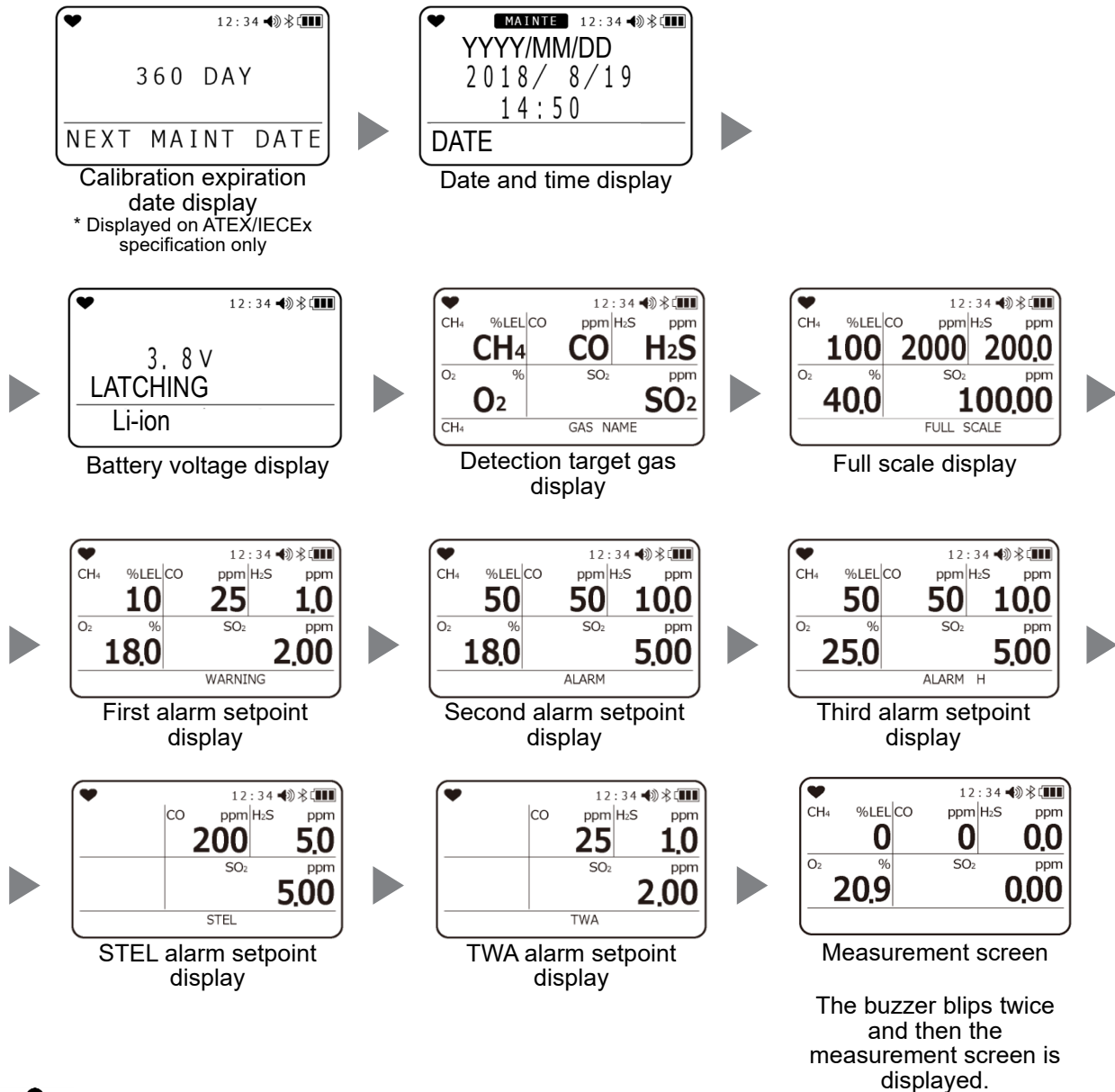

CAUTION

- Only for ATEX/IECEX specification
When the calibration date has expired, indicates that the calibration has expired when the power is turned on. The operation after calibration expiration depends on its setting.
For information on the calibration procedure, see "7-2. Calibration" on page 83.
 - CONFIRM: Allows the user to confirm and select whether to proceed to measurement mode or to Auto calibration cylinder setting.
 - CANT USE: Measurement mode is not available. Proceed to Auto calibration cylinder setting by pressing the button or after 6 seconds.
 - NO EFFECT: Indicates that calibration has expired and allows the user to select whether to proceed to Auto calibration cylinder setting by pressing the button or to measurement mode after 6 seconds when there is no action.



CAUTION

- When the bump test date has expired, indicates that the bump test date has expired when the power is turned on. The operation after bump test expiration depends on its setting.
For information on the bump test procedure, see "7-3. Bump test" on page 94.
 - CONFIRM: Allows the user to confirm and select whether to proceed to measurement mode or to Bump test cylinder setting.
 - CANT USE: Measurement mode is not available. Proceed to Bump test cylinder setting by pressing the button or after 6 seconds.
 - NO EFFECT: Indicates that calibration has expired and allows the user to select whether to proceed to Bump test cylinder setting by pressing the button or to measurement mode after 6 seconds when there is no action.
- With models that detect combustible gases, the screen shown on the right may be displayed with the buzzer sounding and lamp flashing after the battery level and alarm patterns are displayed. When the screen shown on the right is displayed, the alarm is automatically cleared by pressing the **MODE** button or after 5 seconds.
- The screen shown on the right is displayed when the combustible gas sensor is poisoned by silicone compounds, halides, or other substances. When the screen shown on the right is displayed, the combustible gas conversion function can be used only for the gas types marked with "O" in the "Conversion when conversion is restricted" column in the "Conversion gas list" section of "6-2-2. Combustible gas conversion setting." If you wish to continue to use the combustible gas conversion function for gas types marked with "x", please contact RIKEN KEIKI.
- If a gas that cannot be converted has been set, this will automatically return to the calibration gas.
- If any abnormality is detected in the sensor, "FAIL" appears in place of the measured value just before the measurement screen is displayed, and a sensor abnormality alarm is triggered. If this occurs, press the **MODE** button to temporarily reset the sensor abnormality alarm. However, the alarm cannot be reset if there is an abnormality in all of the sensors. After the alarm is reset, "- - -" appears in the concentration display area of the gas for which the sensor abnormality occurred, and detection will not be possible for that gas type. Contact RIKEN KEIKI immediately.
- After startup, perform "5-4. Air calibration" on page 33.

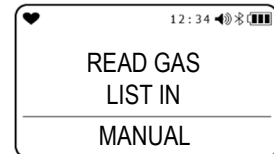

NOTE

- If there is an abnormality in the built-in clock, a “FAIL CLOCK” fault alarm may be triggered. If this occurs, press the **MODE** button. The fault alarm will be temporarily reset, and measurement will be started with the clock time remaining incorrect.

Lunch break

When the lunch break setting is enabled, the screen is displayed with a five-second countdown to allow the user to confirm whether to retain the TWA and PEAK values from the last time the power was turned off and continue measurement or to reset the values when the power is turned on.

Pressing the **MODE** button retains the measurement data, and pressing the **AIR** button resets the measurement data.

Bump test expiration date

When the bump test expiration date setting is enabled, the number of days remaining after the last bump test date until a specified setting date is displayed when the power is turned on. For information on the bump test expiration date setting, see “6-4-4. Bump test setting” on page 60.

Calibration notification display

With ATEX/IECEx specifications only, the calibration expiration date appears when the power is turned on. The calibration expiration date display indicates the number of days remaining after the last calibration date until a specified setting date. For details, see “6-4-3. Calibration expiration date setting” on page 56.

Date and time

Displays the date and time. For information on the date/time setting and display format, see “6-4. User mode settings” on page 56. If an IrDA communication partner device is brought close to the product, it switches to communication mode. Pressing the **AIR** and **MODE** buttons together also switches to communication mode, even when no communication partner device is nearby.

Battery level/alarm pattern

Displays the battery level (voltage) in the upper part of the screen.

Displays the gas alarm pattern setting (LATCHING <self-latching>) in the center of the screen.

Indicates the type of battery used (lithium ion battery) at the bottom of the screen.

Detection target gas

Displays the detection target gas. The gas currently being converted is displayed at the bottom of the screen if a combustible gas is being converted.

If an IrDA communication partner device is brought close to the product, it switches to communication mode. Pressing the **AIR** and **MODE** buttons together also switches to communication mode, even when no communication partner device is nearby.

Full scale

Displays the full-scale value of the detection target gas. IEC or ISO is displayed in the full-scale display area if IEC or ISO LEL values are set.

First alarm setpoint

Displays the first alarm setpoint for the detection target gas.

Second alarm setpoint

Displays the second alarm setpoint for the detection target gas.

Third alarm setpoint

Displays the third alarm setpoint for the detection target gas.

STEL alarm setpoint (TWA and STEL are displayed only for models that detect gases other than combustible gases and oxygen.)

Displays the STEL alarm setpoint for the detection target gas. The STEL value refers to the concentration of a toxic substance that does not adversely affect the user’s health with 15-minute continuous exposure, provided that daily exposures do not exceed the TWA value.

TWA alarm setpoint (TWA and STEL are displayed only for models that detect gases other than combustible gases and oxygen.)

Displays the TWA alarm setpoint for the detection target gas. The TWA value refers to the time-weighted average concentration limit of a toxic substance for a normal 8-hour workday and a 40-hour workweek to which almost all users may be repeatedly exposed without adverse health effect.

5-4. Air calibration

Air calibration refers to zero adjustment required to ensure accurate measurement of gas concentrations.



WARNING

- When air calibration is performed in the atmosphere, check the atmosphere for freshness before starting. The presence of interference gases will make it impossible to perform air calibration correctly and potentially result in hazardous conditions in the event of actual gas leaks.



CAUTION

- After startup, perform air calibration before using the product for gas detection.
- Always perform air calibration under conditions of pressure, temperature, and humidity similar to those in the operating environment and in fresh air.
- Wait for the readout to stabilize before performing air calibration.
- If there is a temperature difference of 15 °C or more between the storage and usage locations, turn on the power and allow the product to stand and acclimatize for about 10 minutes (about 30 minutes if the product is equipped with an ammonia (NH₃) sensor) in an environment similar to the usage location before performing air calibration in fresh air.

By default, air calibration is not performed for the CO₂ sensor. You can enable air calibration for the CO₂ sensor by setting the CO₂ sensor air calibration setting to ON in user mode. For information on how to change the setting, see “6-4-14. CO₂ sensor air calibration: ON/OFF” on page 76. Air calibration adjusts to 400 ppm. Confirm that the surrounding air is fresh. Note that the product will not perform to standard product specifications if you perform air calibration with this setting.

NOTE

- When using the combustible gas conversion function with the long-life battery setting ON, in principle, the indicated value may rise temporarily after power-on, and depending on the alarm setting value, a gas alarm may be issued. Please wait about 5 minutes after power-on and perform air calibration before use.
In particular, Toluene, Xylene, N-nonane, or Methyl isobutyl ketone tend to rise comparatively, so it is recommended to use the product with the long-life battery setting OFF.

Air calibration procedure

- 1 **Hold down the **AIR** button on the measurement screen.**

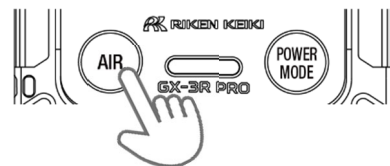

The air calibration screen appears. Keep the **AIR** button pressed for as long as the screen shown on the right is displayed. Air calibration will not be performed if you release the button before the screen is displayed or while it is displayed.



- 2 Release the AIR button once the screen shown on the right appears.**

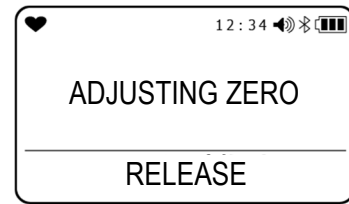

If air calibration has been successfully completed, the display automatically returns to the measurement mode screen.

NOTE

- If air calibration fails, "FAIL" appears in the concentration display area for the faulty sensor. Press the MODE button to reset the fault alarm (calibration failure). Resetting the alarm displays the value before calibration.

5-5. Gas detection



DANGER

- If measuring inside manholes or enclosed spaces, never lean over or look into the manhole or enclosed space. There is a danger that oxygen-deficient air or other gases may be discharged from such locations.



WARNING

- When air calibration is performed in the atmosphere, check the atmosphere for freshness before starting. The presence of interference gases will make it impossible to perform air calibration correctly and potentially result in hazardous conditions in the event of actual gas leaks.
- A gas alarm indicates the presence of extreme danger. The user must take appropriate action based on the situation.
- If the battery voltage drops, gas cannot be detected. If a low battery voltage alarm occurs during use, turn off the power and promptly charge or replace the batteries in a safe place.
- Do not block the buzzer sound opening. Doing so will make the alarm hard to hear.



CAUTION

- Check the settings before starting gas detection.
- When equipped with a carbon dioxide (CO₂) sensor, it may show a high indication immediately after energization due to the characteristics of the sensor
You Warm it up for about 10 to 20 minutes and use it after instructions are stable.
- When an ammonia (NH₃) sensor is installed, the indication may rise temporarily immediately after the sensor is energized due to its characteristics. When replacing the battery before it runs out, please wait at least 10 minutes before turning the power back on. Also. When the sensor is replaced, the battery is replaced because it is dead, or the battery is removed and has not been used for a long period of time, turn the power back on after 120 minutes or more.

5-5-1. Basic operating procedures

Turn on the power to proceed to the measurement mode screen.

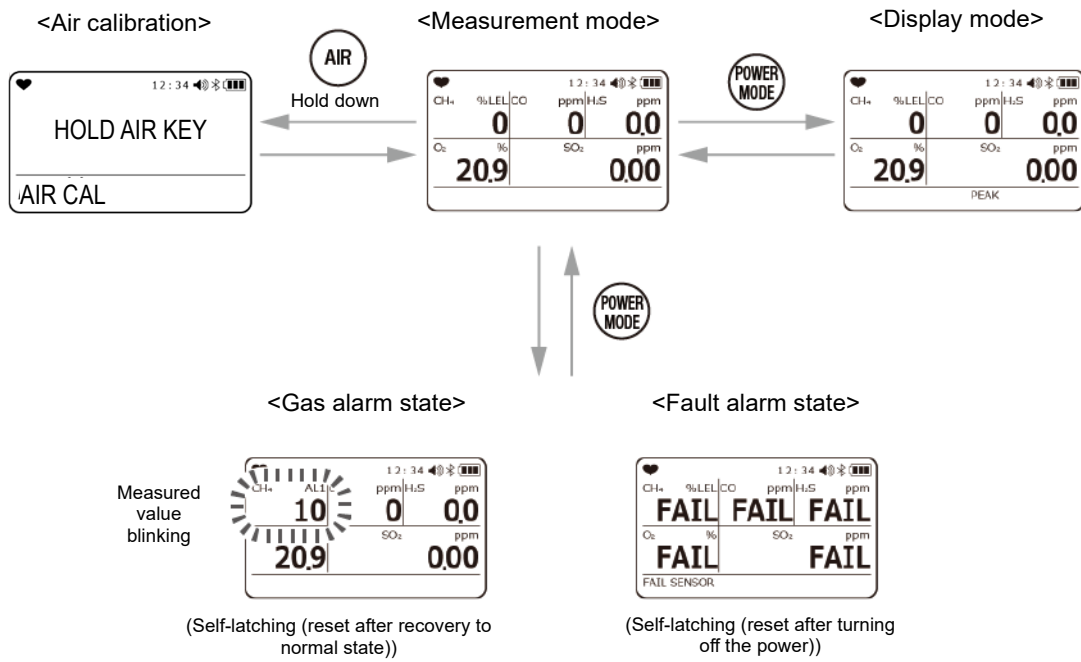

5-5-2. Measurement mode

In measurement mode, read the values on the LCD display.

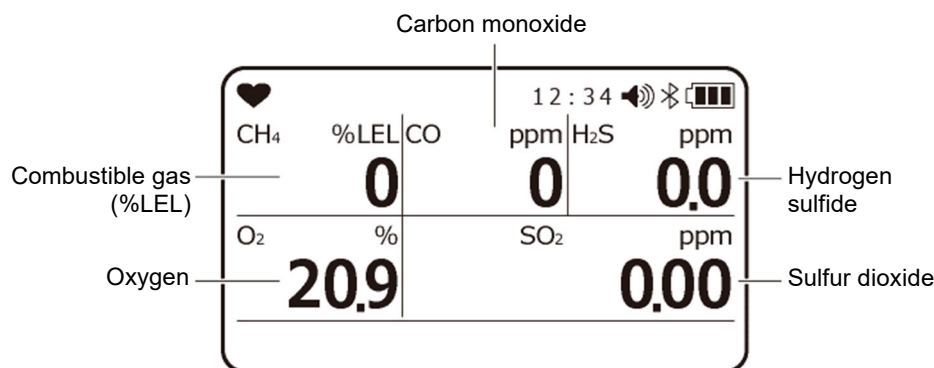

CAUTION

- Note that if combustible gas sensors are used in an environment where silicone compounds, halides, high concentrations of sulfides, or high concentrations of solvent gases are present, sensor life may be reduced, sensitivity to combustible gases may deteriorate, and accurate readings may not be obtained. If use in such environments is unavoidable, use for the shortest possible time and allow the product to stand in fresh air after use. Confirm that the reading returns to normal and is stabilized.
- An oxygen concentration higher than a certain level is required in order for the combustible gas sensor <%LEL> in the product to correctly detect gases and display concentrations.
- Do not expose the product to sudden pressure fluctuations. Oxygen readings will vary temporarily, preventing accurate measurement.
- Do not use any gas other than nitrogen as the balance gas when calibrating or adjusting an oxygen sensor. Otherwise, oxygen reading errors will increase, preventing accurate measurement.
- If the product is exposed to highly adsorptive gas, allow it to stand in fresh air. Confirm that the reading returns to zero before use.
- The zero point for carbon monoxide (CO) and hydrogen sulfide (H₂S) sensors may fluctuate at low or high temperatures. If this occurs, perform air calibration in the ambient atmosphere.
- The hydrogen sulfide (H₂S) sensor may exhibit temporary fluctuations if exposed to sudden temperature variations. Allow the product to stand and acclimatize in the ambient atmosphere.

NOTE

- The gas currently being converted is displayed at the bottom of the screen if a combustible gas is being converted.
- The operating time will be reduced due to battery performance in cold environments.
- The response of the LCD display may slow at low temperatures.
If the product is exposed to a combustible gas at concentrations of 100 %LEL or above, some adsorbed gas may remain in the filter. After drawing in high-concentration combustible gas, always allow the product to stand in fresh air. Perform air cleaning until the reading returns to around zero to remove any adsorbed gases. Performing air calibration before a complete cleaning will result in inaccurate adjustments, with potential adverse effects on measurement. Locking over will occur if 100 %LEL is detected. This will not be reset until either the oxygen concentration decreases or you press the MODE button.
- The toxic gas sensor zero point may fluctuate when the temperature is low or high.
- The ammonia (NH₃) sensor may show temporary fluctuations in indication in response to sudden changes in humidity*. Allow the sensor to acclimate sufficiently in an ambient atmosphere before turning it on again.
*e.g., entering a room from outdoors when it's raining, covering the sensor with your hand.

- The carbon monoxide sensor (ESR-A1CP) includes a correction function to reduce interference due to hydrogen. This function works for hydrogen concentrations up to 2,000 ppm. However, if used in an environment exceeding 40°C for more than 15 minutes, it may be affected by hydrogen interference and may indicate a higher carbon monoxide concentration than actual.
- If the carbon monoxide sensor (ESR-A1CP) detects hydrogen at a concentration of 2,000 ppm or higher, [H2] and [RICH] are displayed alternately in the concentration display area. While measurement can continue, errors will arise with carbon monoxide concentration readings due to the significant effects of hydrogen interference..

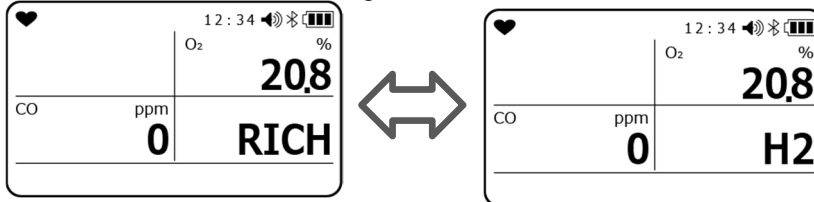

Concentration display: RICH

Concentration display: H2

- Sensitivity may be reduced temporarily if the carbon monoxide (CO) and hydrogen sulfide (H₂S) sensors come into contact with gas at concentrations exceeding their measurement range. If the sensors have come into contact with high-concentration gas, be sure to allow them to stand in fresh air and perform air cleaning.
- The display will not switch to display mode if an alarm is currently active.
- If you are measuring for 20 minutes or more outside the operating temperature range, temperature range error will be triggered. If temperature range error is triggered, leave it for 5 minutes or more within the operating temperature range or turn off the power of the main unit.

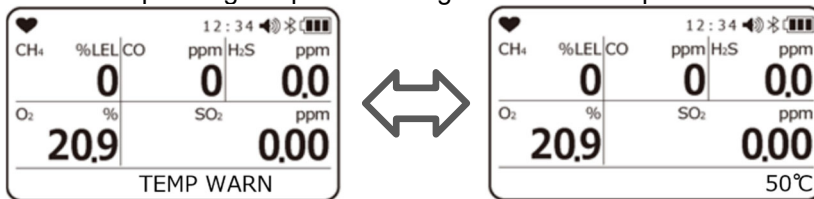

5-6. Turning off the power



CAUTION

- If the concentration display does not return to zero (or 20.9 % for the oxygen concentration display) after measurement is completed, allow the product to stand in fresh air until the display returns to zero before turning power off.

Hold down the **POWER** button.

To turn off the power, wait for the display to return to zero (or 20.9 % for oxygen) in a safe place, then hold down the **POWER** button.

The buzzer blips three times and “TURN OFF” appears on the display before the power turns off.

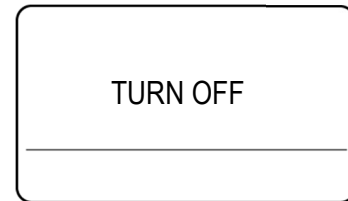

Power-off display

NOTE

- When turning off the power, hold down the button until the display turns off.



CAUTION

- If the product has become dirty, wipe it with a rag or cloth soaked in water and firmly wrung out.
- When wiping the product clean, do not use organic solvents like alcohol or benzine or commercially available cleaners.

6

Setting Procedure

6-1. Display mode

Display mode lets users review and change various display settings and perform other operations. Changed settings are saved.

6-1-1. Displaying display mode

Press the **MODE button on the measurement mode screen.**

Pressing the **MODE** button displays the various screens in sequence.

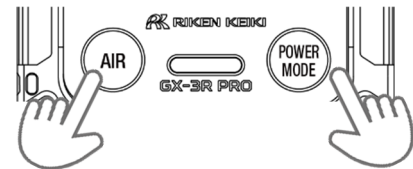

To change a setting, press the **AIR button.**

The setting screen is displayed.

Press the **MODE button once settings are complete.**

The settings are saved and the display returns to the previous screen.





To return to the measurement mode screen, press the **MODE button several times in display mode.**

NOTE

- If no action is taken for about 20 seconds, the display will return to the measurement screen.
- To test the alarm, press the **AIR** button and **MODE** button at the same time while an alarm setpoint is displayed.
- Hold down the **AIR** button and **MODE** button at the same time in display mode to return to measurement mode.
- To cancel before finalizing changes to the settings, hold down the **AIR** button and **MODE** button at the same time. The display returns to display mode.

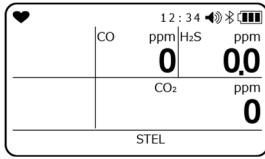
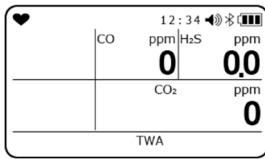
6-1-2. Display mode display details

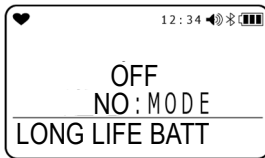
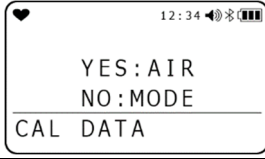
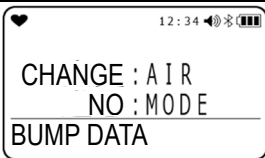
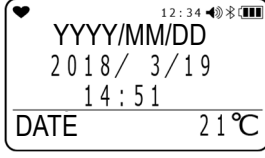
Screen notation (Setting item)	Display contents	LCD display	Reference page
PEAK (PEAK display/PEAK reset)	Displays the maximum gas concentration (or minimum oxygen concentration) detected since the power was turned on.		Hold down the AIR button to jump to the PEAK CLEAR screen on page 43.

Screen notation (Setting item)	Display contents	LCD display	Reference page
STEL (STEL display) * Displays only CO, H ₂ S, SO ₂ , NO ₂ , HCN, PH ₃ , NH ₃ and CO ₂ (vol%)	Displays the STEL value since the power was turned on. The STEL value refers to the sum of 15 pieces of average value data for measured values over a period of 60 seconds divided by 15. The value is refreshed every 60 seconds.		-----
TWA (TWA display) * Displays only CO, H ₂ S, SO ₂ , NO ₂ , HCN, PH ₃ and CO ₂	Displays the TWA value since the power was turned on. The TWA value refers to the integrated average value of measured values over a period of 60 seconds divided by 480. The value is refreshed every 60 seconds.		-----
HC GAS LIST (Combustible gas conversion setting) * Displayed only on models that detect combustible gases.	Selects the conversion gas from the list of gases preregistered in the product.		Press the AIR button to jump to the setting screen on page 44.
LONG LIFE BATT (Long-life battery setting) * Displayed only on models that detect combustible gases.	Enables/disables the long-life battery function.		Press the AIR button to jump to the setting screen on page 46.
CAL DATA (Calibration data display) * Displayed on ATEX/IECEx specification only	Displays the calibrated gas type and the calibration date.		Press the AIR button to jump to the setting screen on page 47.
BUMP DATA (Bump data display)	Displays the bump test gas type and the test date.		Press the AIR button to jump to the setting screen on page 48.
DATE (Date and time and temperature display)	Displays the date, time, and temperature.		-----
ALARM POINTS (Alarm setpoint display)	Displays various alarm setpoints.		Press the AIR button to jump to the confirmation screen on page 49.

Screen notation (Setting item)	Display contents	LCD display	Reference page
INVERT SELECT (LCD inversion setting)	Inverts the LCD display by 180 degrees depending on the orientation of the product.		Press the AIR button to jump to the setting screen on page 50.
LCD BACKGROUND (LCD background inversion)	Inverts black and white for the LCD display.		Press the AIR button to jump to the setting screen on page 51.
BLUETOOTH (Bluetooth setting)	Enables/disables Bluetooth.		Press the AIR button to jump to the setting screen on page 51.
BUZZER VOLUME (Buzzer volume adjustment)	Adjusts the alarm buzzer volume.		Press the AIR button to jump to the setting screen on page 52.
LANGUAGE CHANGE (Display language change) * Displayed on ATEX/IECEX specification only	Restores the English language display when another language has been set.		Press the AIR button to jump to the setting screen on page 52.

NOTE

- The previously measured PEAK and TWA values retained the last time the power was turned off are displayed when the lunch break function is enabled.
- HC GAS (combustible conversion gas selection) is not displayed for calibration gas types other than CH₄ or i-C₄H₁₀.
- Bump data is displayed if the bump test expiration date display is enabled in user mode.
- Calibration data is displayed if the calibration expiration date display is enabled in user mode.
- The temperature displayed in the date and time and temperature display is the internal temperature of the product. This value differs from the actual ambient temperature.

6-2. Display mode settings

Switch to display mode from the measurement screen and check and change settings in display mode.

6-2-1. Clearing PEAK value display

This clears the PEAK value (the maximum gas concentration or minimum oxygen concentration measured since the power was turned on).

- 1 Press the **MODE** button on the measurement screen to display the **PEAK** screen.
- 2 Hold down the **AIR** button (for three seconds).

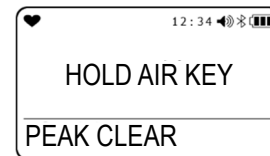
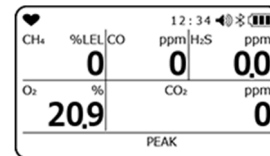

- 3 Release the **AIR** button once the **"RELEASE"** is displayed on the screen.

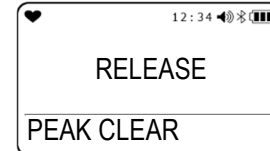

The PEAK value is cleared and "END" appears and the display returns to the screen in Step 1.

6-2-2. Combustible gas conversion setting

Combustible gas measurements can be displayed as a concentration converted to a gas preregistered in the product.

The following combustible gases can be converted:

<Conversion gas list>

Conversion gas	Gas name displayed	Gas conversion		Conversion when conversion is restricted
		CH4	i-C4H10	
Methane	CH4	-	×	○
Isobutane	i-C4H10	○	-	○
Hydrogen	H2	○	○	○
Methanol	CH3OH	○	○	×
Acetylene	C2H2	○	○	○
Ethylene	C2H4	○	○	○
Ethane	C2H6	○	×	○
Ethanol	C2H5OH	○	○	×
Propylene	C3H6	○	○	○
Acetone	C3H6O	○	○	×
Propane	C3H8	○	×	○
Butadiene	C4H6	○	○	○
Cyclopentane	C5H10	○	○	○
Benzene	C6H6	○	○	×
n-Hexane	n-C6H14	○	○	○
Toluene	C7H8	○	○	×
n-Heptane	n-C7H16	○	○	○
Xylene	C8H10	○	○	×
n-Nonane	n-C9H20	○	○	×
Ethyl acetate	EtAc	○	○	×
Isopropyl alcohol	IPA	○	○	×
Methyl ethyl ketone	MEK	○	○	×
Methyl methacrylate	MMA	○	○	×
Dimethyl ether	DME	○	○	×
Methyl isobutyl ketone	MIBK	○	○	×
Tetrahydrofuran	THF	○	○	×
n-Pentane	n-C5H12	○	○	○



CAUTION

- On models that detect combustible gases, the screen shown on the right may be displayed with the buzzer sounding and lamp flashing after the power is turned on or calibration is performed. When the screen shown on the right is displayed, the alarm is automatically cleared by pressing the **MODE** button or after 5 seconds.
- The screen shown on the right right is displayed when the combustible sensor is poisoned by silicone compounds, halides, or other substances. When the screen shown on the right is displayed, the combustible gas conversion function can be used only for the gas types marked with "○" in the "Conversion when conversion is restricted" column in the "Conversion gas list" section of "6-2-2. Combustible gas conversion setting." If you wish to continue to use the combustible gas conversion function for gas types marked with "×", please contact RIKEN KEIKI.

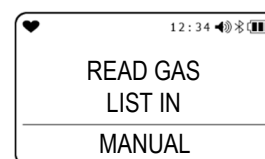

NOTE

- Combustible gas conversion setting is displayed for CH₄ and i-C₄H₁₀.
- This does not appear if "Display mode item display: ON/OFF" is disabled in user mode.
- To cancel before finalizing changes to the settings, hold down the **AIR** button and **MODE** button at the same time. The display returns to display mode.
- The alarm accuracy and alarm delay time shown in the specifications list apply only for the calibration gas.
- The concentration display when converted should be treated as approximate.
- If conversion is used, the indication accuracy for the product will not be achieved.
- The combustible gas sensor of this instrument may not be able to use the combustible gas conversion function for some gases according to its specifications. Check the gas monitor specifications in "1-3. Checking the detection target gases" and confirm whether the gas can be read or not in the "Conversion gas list" in "6-2-2. Combustible gas conversion setting." Even if a combustible conversion gas is selected, the indicated value will be affected if other combustible gases are present in the usage environment. However, if hydrogen (H₂) is selected as the conversion gas, the gases with "x" in the "Conversion when the conversion is restricted" column of the "Conversion gas list" do not affect the indicated value even if they are present in the operating environment.
- When using the combustible gas conversion function with the long-life battery setting ON, in principle, the indicated value may rise temporarily after power-on, and depending on the alarm setting value, a gas alarm may be issued. Please wait about 5 minutes after power-on and perform air calibration before use.
In particular, Toluene, Xylene, N-nonane, or Methyl isobutyl ketone tend to rise comparatively, so it is recommended to use the product with the long-life battery setting OFF.

- 1 Press the **MODE** button on the measurement screen several times to display the HC GAS LIST screen.**

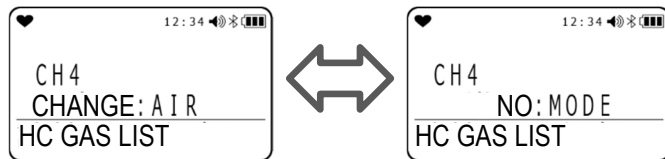

- 2 Press the **AIR** button several times to display the combustible gas you want to change.**

Pressing the **AIR** button toggles through the list of combustible gases. The default setting is the calibration gas for the combustible gas sensor.

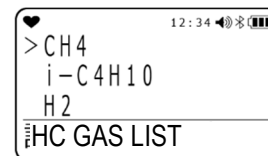

- 3 Press the **MODE** button when the combustible gas to be changed is displayed on the screen.**

"END" appears and the display returns to the screen in Step 1.

6-2-3. Long-life battery setting

This enables/disables the LONG LIFE BATT setting. The default setting is "OFF".

When set to "ON", the combustible gas concentration is refreshed every 15 seconds instead of every 5 seconds.

NOTE

- The setting is retained even when the power is turned off.
- This does not appear if "Display mode item display: ON/OFF" is disabled.
- If LONG LIFE BATT is enabled, no minus sensor alarm will be issued for the combustible gas sensor.
- The "L" lights up at the top left of the screen when LONG LIFE BATT is enabled.
- When using the combustible gas conversion function with the long-life battery setting ON, in principle, the indicated value may rise temporarily after power-on, and depending on the alarm setting value, a gas alarm may be issued. Please wait about 5 minutes after power-on and perform air calibration before use.
In particular, Toluene, Xylene, N-nonane, or Methyl isobutyl ketone tend to rise comparatively, so it is recommended to use the product with the long-life battery setting OFF.

- 1 Press the **MODE** button on the measurement screen several times to display the LONG LIFE BATT screen.**

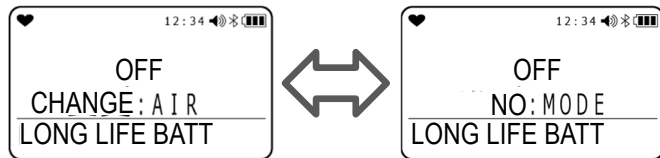

- 2 Press the **AIR** button to select "ON" or "OFF".**
The default setting is "OFF".

- 3 Press the **MODE** button.**

"END" appears and the display returns to the screen in Step 1.

6-2-4. Calibration data display

This displays the calibrated gas type and the calibration date.

NOTE

- Calibration data is not displayed if the calibration expiration date setting is disabled in user mode.
- Calibration data is displayed only on ATEX/IECEX specification.

1 Press the **MODE button on the measurement screen several times to display the **CAL DATA** screen.**

2 Press the **AIR button.**

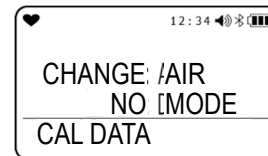

Pressing the **AIR** button cycles the display through "CH4" → "O2" → "H2S" → "CO" → "CO2" → ...

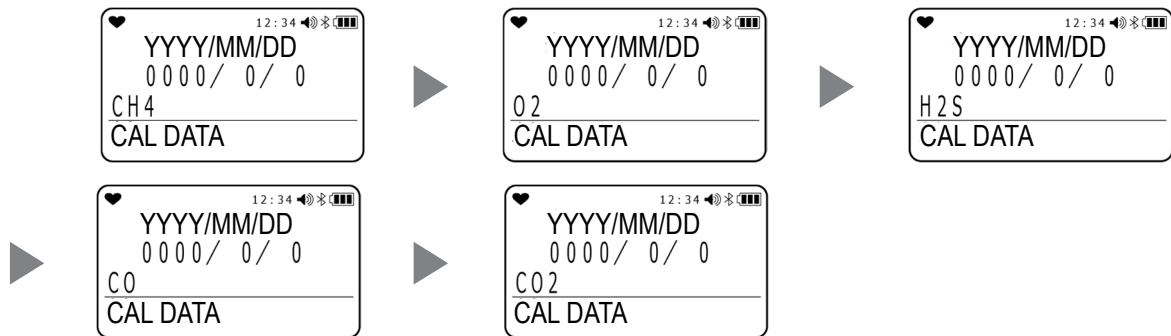

3 Press the **MODE button.**

"END" appears and the display returns to the screen in Step 1.

6-2-5. Bump data display

This displays the bump test expiration function bump test expiration date and gas type.

NOTE

- Bump data is not displayed if the bump test expiration date setting is disabled in user mode.

1 Press the **MODE button on the measurement screen several times to display the **BUMP DATA** screen.**

2 Press the **AIR button.**

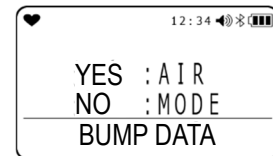

Pressing the **AIR** button cycles the display through “CH4” → “O2” → “H2S” → “CO” → “CO2” → ...

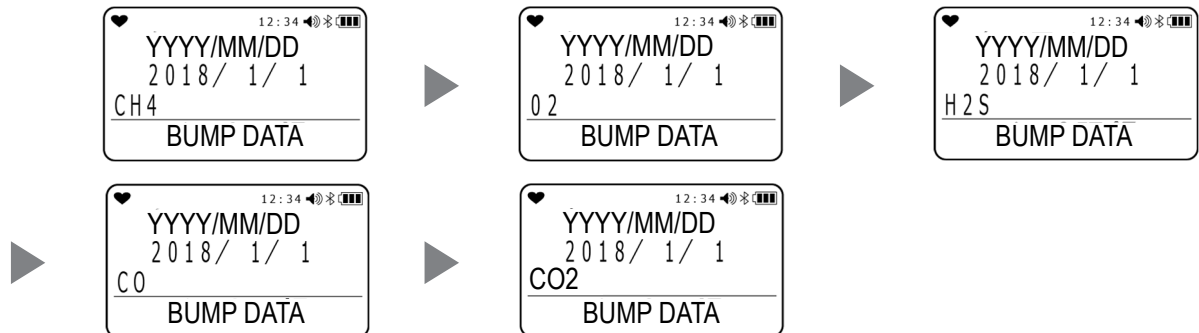

3 Press the **MODE button.**

“END” appears and the display returns to the screen in Step 1.

6-2-6. Alarm setpoint display

This allows alarm setpoints to be displayed and testing of LED, buzzer, and vibration operations.

NOTE

- TWA and STEL are displayed only on models that detect gases other than combustible gases and oxygen.

1 Press the **MODE button on the measurement screen several times to display the **ALARM POINTS** screen.**

2 Press the **AIR button.**

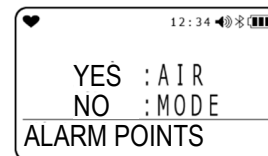

Pressing the **AIR** button cycles the display through “FULL SCALE” → “WARNING” → “ALARM” → “ALARM H” → “STEL” → “TWA” → “FULL SCALE” → ...

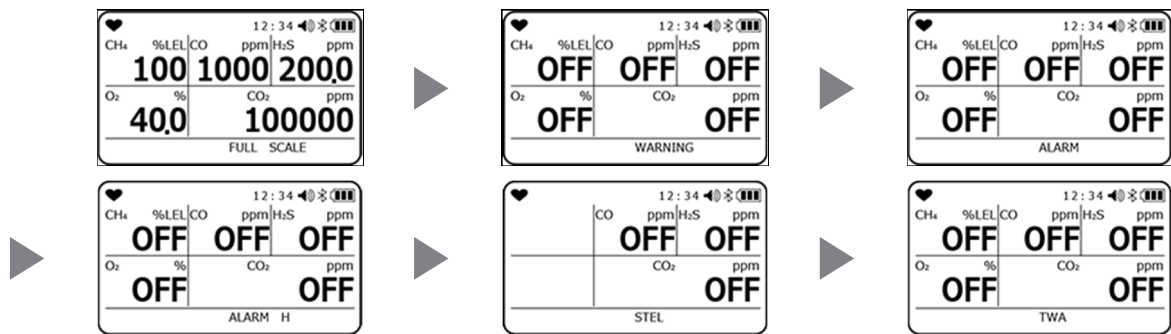

The corresponding alarm can be tested by pressing the **AIR** button and **MODE** button at the same time. Press any button to reset the alarm.

3 Press the **MODE button.**

The display returns to the screen in Step 1.

6-2-7. LCD inversion setting

This flips the LCD display 180 degrees as follows, depending on the orientation of the product:

“ON”	Displays the screen inverted 180 degrees to the orientation of the product.
“OFF”	Displays the screen in the same orientation as the product.
“AUTO”	Switches the screen display depending on the orientation of the product.

NOTE

- The setting is retained even when the power is turned off.
- This does not appear if “Display mode item display: ON/OFF” is disabled in user mode.

1 Press the **MODE button on the measurement screen several times to display the **INVERT SELECT** screen.**

2 Press the **AIR button.**

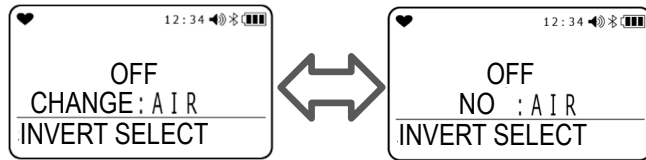

Pressing the **AIR** button cycles the display through “ON” → “OFF” → “AUTO” → ...
The default setting is “OFF”.

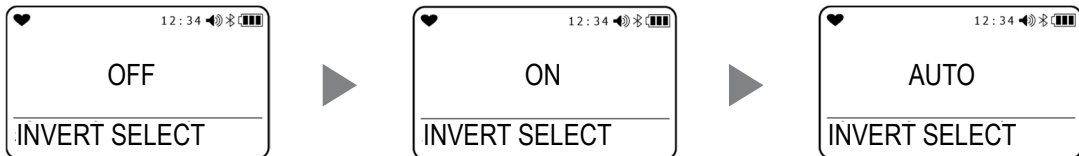

3 Press the **MODE button.**

“END” appears and the display returns to the screen in Step 1.

6-2-8. LCD background setting

This inverts black and white for the LCD display to display white letters on a black background.

NOTE

- The setting is retained even when the power is turned off.
- This does not appear if “Display mode item display: ON/OFF” is disabled in user mode.

1 Press the **MODE button on the measurement screen several times to display the LCD BACKGROUND screen.**

2 Press the **AIR button to select “ON” or “OFF”.**

The default setting is “OFF”.

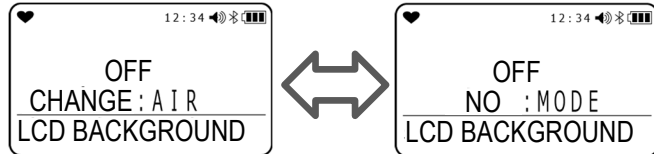

3 Press the **MODE button.**

“END” appears and the display returns to the screen in Step 1.



6-2-9. Bluetooth setting

This sets whether to start Bluetooth communication. Enabling this setting allows communication with devices such as smartphones and tablet PCs to which the dedicated application has been downloaded.

1 Press the **MODE button on the measurement screen several times to display the BLUETOOTH screen.**

2 Press the **AIR button to select “ON” or “OFF”, then press the **MODE** button.**

The default setting is “OFF”.

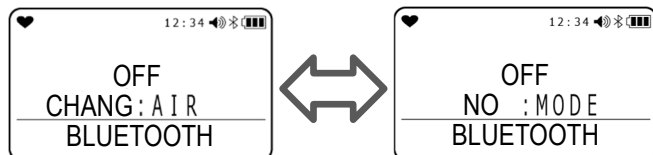

“END” appears and the display returns to the screen in Step 1.

NOTE

- The setting is retained even when the power is turned off.
- This does not appear if “Display mode item display: ON/OFF” is disabled in user mode.
- Bluetooth function is option for ATEX/IECEX specification.
- Download “RK Link” app on Google Play (Android) or the App Store (iOS), and follow the simple directions.
- Bluetooth function turns off in 5 minutes of inactivity after turning ON. This setting can be changed with the data logger management program (sold separately).

6-2-10. Buzzer volume adjustment

This adjusts the alarm buzzer volume.

- 1 Press the **MODE** button on the measurement screen several times to display the **BUZZER VOLUME** screen.**

- 2 Press the **AIR** button to select “HIGH” or “LOW”, then press the **MODE** button.**

The default setting is “HIGH”.

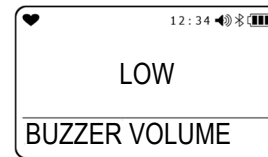
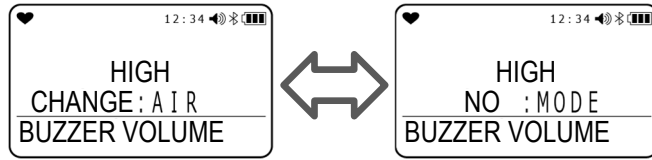

“END” appears and the display returns to the screen in Step 1.

NOTE

- The setting is retained even when the power is turned off.
- This does not appear if “Display mode item display: ON/OFF” is disabled in user mode.

6-2-11. Display language setting

<Procedure for ATEX/IECEX specification>

This appears if a language other than English has been set. The function restores the display language to English.

- 1 Press the **MODE** button on the measurement screen several times to display the **LANGUAGE CHANGE** screen.**

- 2 Press the **AIR** button.**

The language change confirmation screen is displayed.

The default setting is “ENGLISH”.

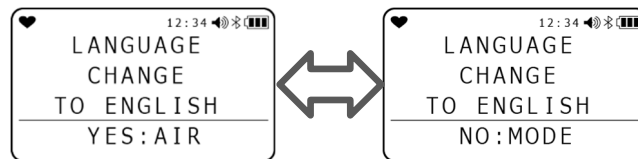

- 3 Press the **MODE** button.**

The display switches to Japanese and returns to the measurement screen.

Pressing the **AIR** button returns the display to the screen in Step 1 with the display language set to English.

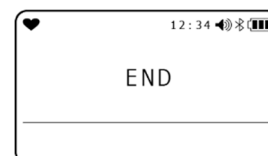
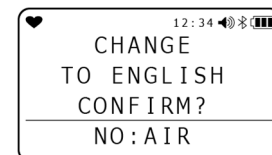
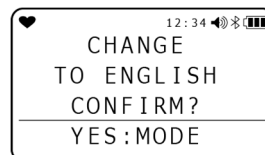

NOTE

- The setting is retained even when the power is turned off.
 - Once the original display language has been restored, the display language cannot be changed to a language other than the original language in display mode. For information on changing the display language, see “6-4-17. Language setting” in “User mode settings” on page 78.
-

6-3. User mode

User mode lets you set the date and time, alarm setpoints, and other settings.

6-3-1. Displaying user mode

- 1 **With the power turned off, press the **AIR** button and **POWER** button at the same time.**

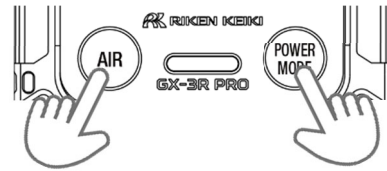

- 2 **Release the buttons when the buzzer blips.**

The power turns on, and the user mode menu appears.



- 3 **Use the **AIR** button to select an item to be set, then using the **MODE** button, go to the setting screen.**



- 4 **Once settings are complete, press the **AIR** button on the user mode menu several times to select “START MEASURE”, then press the **MODE** button.**

The product operates in the same way as when the power has just been turned on and proceeds to the measurement screen.

NOTE

- The display returns to the user mode menu after each setting. To return to the menu while making the settings, hold down the **AIR** button and **MODE** button at the same time.
- A password input screen is displayed if the password setting is enabled in user mode. For information on how to change the default password, see “6-4-18. User password setting”.

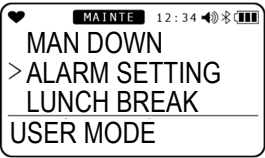
6-3-2. User mode settings

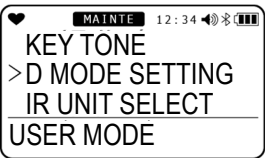
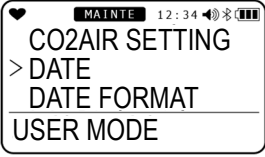
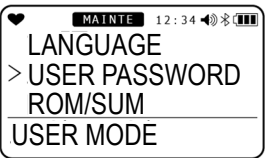
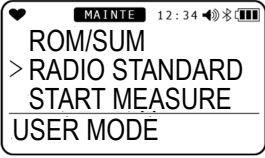
Screen display (setting item)	LCD display	Reference page
BUMP TEST		P. 94
GAS CAL (Calibration)		P. 86
CAL SETTING (Calibration expiration date setting) * Displayed on ATEX/IECEX specification only		P. 56
BUMP SETTING		P. 56
MAN DOWN		P. 66
ALARM SETTING		P. 68
LUNCH BREAK		P. 71
CONFIRMATION		P. 71
AUTO BACKLIGHT		P. 74
BACKLIGHT TIME		P. 74
KEY TONE		P. 75
D MODE SETTINGS		P. 75
IR UNIT SELECT (Unit switching for CO₂ sensor) * Displayed only on models that detect CO ₂ . May not be displayed if the CO ₂ sensor is not connected correctly.		P. 76
CO2AIR SETTING (CO₂ sensor air calibration: ON/OFF) * Displayed only on models that detect CO ₂ . May not be displayed if the CO ₂ sensor is not connected correctly.		P. 76
DATE		P. 77
DATE FORMAT		P. 77
LANGUAGE		P. 78
USER PASSWORD		P. 79
ROM/SUM		P. 80
RADIO STANDARD * Not displayed on certain models		P. 80
START MEASURE		

6-4. User mode settings

User mode allows settings to be changed to increase usability.

6-4-1. Bump test

The product includes a function for performing a bump test (function check).

Here, you can select "Perform Bump Test (BUMP TEST)" and "Switch to measurement start screen from bump test (BUMP TEST)".

After the bump test is successful, the screen will automatically move to the measurement start screen.

*If multiple cylinder settings are selected, the measurement start screen will not move automatically after the success of bump test.

For information on the bump test procedure, see "7-3. Bump test" on page 94.

6-4-2. Calibration

The product's GAS CAL mode allows automatic calibration using preset gas concentrations in addition to air calibration.

Span adjustment requires dedicated tools and a calibration gas. Contact RIKEN KEIKI.

After successful gas calibration, the screen will automatically move to the measurement start screen.

*If multiple cylinder settings are selected, the measurement start screen will not move automatically after the success of bump test.

For information on the calibration procedure, see "7-2. Calibration" on page 83.

NOTE

- Once setting is complete, press the **AIR** button to select "ESCAPE", then press the **MODE** button. The display returns to the user mode menu.

6-4-3. Calibration expiration date setting

This section describes "Calibration expiration date: ON/OFF", "Calibration expiration date interval", "Operation after calibration date expired", and "Calibration gas setting".

* Displayed on ATEX/IECEx specification only

NOTE

- Once setting is complete, press the **AIR** button to select "ESCAPE", then press the **MODE** button. The display returns to the user mode menu.

<Calibration expiration date setting menu>

- Press the **AIR** button on the user mode menu to select "CAL SETTING", then press the **MODE** button.

The calibration expiration date setting menu screen is displayed.

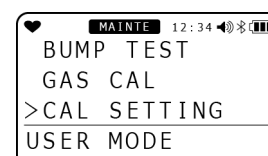

- 2 Press the **AIR** button to select the required setting, then press the **MODE** button.

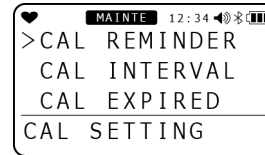

Setting item	LCD display	Reference page
CAL REMINDER		<Calibration expiration date: ON/OFF> P. 57
CAL INTERVAL		<Calibration expiration date interval> P. 58
CAL EXPIRED		<Operation after calibration date expired> P. 58
CAL CHECK GAS		<Calibration expiration date check gas selection> P. 59
ESCAPE		

<Calibration expiration date: ON/OFF>

This lets you enable and disable the calibration expiration date.

- 1 Press the **AIR** button to select “CAL REMINDER”, then press the **MODE** button.

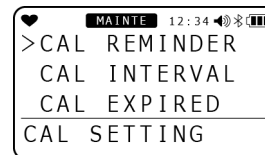

- 2 Press the **AIR** button to select ON or OFF for the calibration expiration date setting, then press the **MODE** button.

Pressing the **AIR** button toggles between ON and OFF for the calibration expiration date setting. The default setting for ATEX/IECEx specification is “ON”.



- 3 Press the **MODE** button.

“END” appears and the display returns to the calibration expiration date setting menu.

<Calibration expiration date interval>

This lets you select the number of days until the calibration expires.

- 1 Press the **AIR** button to select “**CAL INTERVAL**”, then press the **MODE** button.

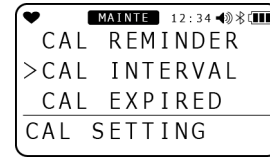

- 2 Press the **AIR** button to select the number of days for calibration expiration, then press the **MODE** button.

Pressing the **AIR** button lets you select the calibration expiration date interval between 1 and 1,000 days. The default setting is “365 DAYS”.



- 3 Press the **MODE** button.

“END” appears and the display returns to the calibration expiration date setting menu.

<Operation after calibration date expired>

This lets you specify the operation after the calibration date has expired.

- 1 Press the **AIR** button to select “**CAL EXPIRED**”, then press the **MODE** button.

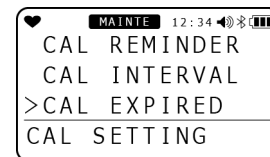

- 2 Press the **AIR** button to select the operation after the calibration date has expired.

- CONFIRM TO USER:
Action depends on the operation. Press the **AIR** button to proceed to measurement mode. Press the **MODE** button to proceed to Auto calibration cylinder setting.
- CANT USE: Measurement mode is not available. Press the **MODE** button or after 6 seconds without any operation to proceed to Auto calibration cylinder setting.
- NO EFFECT: Action depends on the operation. After the indication that calibration has expired, press the **MODE** button to proceed to Auto calibration cylinder setting. After 6 seconds without any operation, proceed to measurement mode automatically.



The default setting is “CONFIRM TO USER”.

- 3 Press the **MODE** button.
“END” appears and the display returns to the calibration expiration date setting menu.

<Calibration expiration date check gas selection>

Allows you to select the gas for which the calibration expiration date is to be checked.

- 1 Press the **AIR** button to select “CAL CHECK GAS”, then press the **MODE** button.**

The gas for calibration can be selected.



- 2 Press the **AIR** button to select the gas for which the calibration expiration date is to be checked.**

Pressing the **AIR** button lets you select the gas type for which the calibration expiration date is to be checked.

- ALL GAS: All sensors
 - 4GAS: All sensors other than the fourth slot
- The default setting is “ALL GAS”.

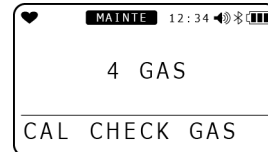

- 3 Press the **MODE** button.**

“END” appears and the display returns to the calibration expiration date setting menu.

6-4-4. Bump test setting

This lets you set various conditions for bump testing.

<Bump test setting menu>

- 1 Press the **AIR** button on the user mode menu to select “BUMP SETTING”, then press the **MODE** button.

The bump test setting screen is displayed.

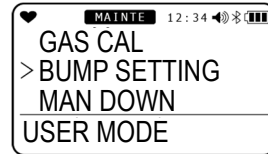

- 2 Press the **AIR** button to select the required setting, then press the **MODE** button.



Setting item	LCD display	Reference page
BUMP PARAMETER		<Bump time selection> P. 61 <Bump tolerance selection> P. 61 <Calibration time selection after bump test> P. 62 <Calibration after bump test: ON/OFF> P. 62
BUMP REMINDER		<Calibration after bump test: ON/OFF>P.62
BUMP INTERVAL		<Bump test expiration date interval selection>P.63
BUMP EXPIRED		<Operation selection after bump test expiration> P. 64
BUMP CHECK GAS		<Bump test gas selection> P. 65
ESCAPE		

NOTE

- Once setting is complete, press the **AIR** button to select “ESCAPE”, then press the **MODE** button. The display returns to the user mode menu.

<Bump time selection>

This sets the time for introducing the test gas.

- 1 **Press the **AIR** button to select “BUMP PARAMETER”, then press the **MODE** button.**

The bump test setting menu is displayed.



- 2 **Press the **AIR** button to select “GAS TIME”, then press the **MODE** button.**

The bump time is displayed.



- 3 **Press the **AIR** button to select the bump time, then press the **MODE** button.**

Pressing the **AIR** button lets you select the bump time from a choice of 30, 45, 60, and 90 seconds. The default setting is “30 SEC”.

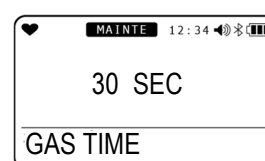

- 4 **Press the **MODE** button.**

“END” appears and the display returns to the bump test setting menu.

<Bump tolerance selection>

This sets the threshold for checking the test gas.

Gases other than oxygen: Calibration concentration \pm (calibration concentration \times tolerance)

Oxygen: Calibration concentration \pm (difference between calibration concentration and 20.9 % \times tolerance)

- 1 **Press the **AIR** button to select “BUMP SETTING”, then press the **MODE** button.**

The bump setting menu is displayed.

- 2 **Press the **AIR** button to select “BUMP PARAMETER”, then press the **MODE** button.**

The bump test setting menu is displayed.



- 3 **Press the **AIR** button to select “TOLERANCE”, then press the **MODE** button.**

The bump tolerance is displayed.



- 4 **Press the **AIR** button to select the bump tolerance, then press the **MODE** button.**

Pressing the **AIR** button lets you select the bump tolerance from a choice of 10, 20, 30, 40, and 50 %. The default setting is “50 %”.

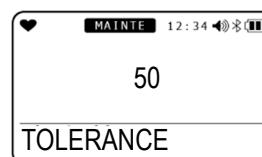

- 5 **Press the **MODE** button.**

“END” appears and the display returns to the bump test setting menu.

<Calibration time selection after bump test>

This selects the time for calibration after a bump test has failed.

- 1 Press the AIR button to select “BUMP SETTING”, then press the MODE button.**

The bump setting menu is displayed.



- 2 Press the AIR button to select “BUMP PARAMETER”, then press the MODE button.**

The bump test setting menu is displayed.



- 3 Press the AIR button to select “CAL TIME”, then press the MODE button.**

The time for calibration after a bump test has failed is displayed.

- 4 Press the AIR button to select the calibration time after a bump test, then press the MODE button.**

Pressing the AIR button lets you select the calibration time after a bump test from a choice of 90 and 120 seconds. The default setting is “90 SEC”.

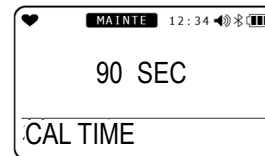

- 5 Press the MODE button.**

“END” appears and the display returns to the bump test setting menu.

<Calibration after bump test: ON/OFF>

This enables/disables the function for automatic calibration if a bump test fails.

- 1 Press the AIR button to select “BUMP PARAMETER”, then press the MODE button.**

The bump setting menu is displayed.



- 2 Press the AIR button to select “BUMP PARAMETER”, then press the MODE button.**

The bump test setting menu is displayed.



- 3 Press the AIR button to select “AUTO CAL”, then press the MODE button.**

The ON/OFF selection is displayed for calibration after a bump test.

- 4 Press the AIR button to select ON or OFF for calibration after a bump test, then press the MODE button.**

Pressing the AIR button lets you select ON or OFF for calibration after a bump test. The default setting is “ON”.



- 5 Press the MODE button.**

“END” appears and the display returns to the bump test setting menu.

<Bump test expiration date display: ON/OFF>

This selects the notification for bump test expiration.

- 1 Press the **AIR** button to select “BUMP SETTING”, then press the **MODE** button.**

The bump setting menu is displayed.

- 2 Press the **AIR** button to select “BUMP REMINDER”, then press the **MODE** button.**

The ON/OFF selection is displayed for bump test expiration date display.



- 3 Press the **AIR** button to select ON or OFF for the bump test expiration date display.**

Pressing the **AIR** button lets you select ON or OFF for the bump test expiration date display. The default setting is “OFF”.



- 4 Press the **MODE** button.**

“END” appears and the display returns to the bump test setting menu.

<Bump test expiration date interval selection>

This sets the interval until the bump test expiration date notification is given after a bump test.

- 1 Press the **AIR** button to select “BUMP SETTING”, then press the **MODE** button.**

The bump setting menu is displayed.

- 2 Press the **AIR** button to select “BUMP INTERVAL”, then press the **MODE** button.**

You can select the number of days until the bump test expiration date.



- 3 Press the **AIR** button to select ON or OFF for the bump test expiration date interval.**

Pressing the **AIR** button lets you select the bump test expiration date interval from 0 to 365 days. The default setting is “30 DAY”.

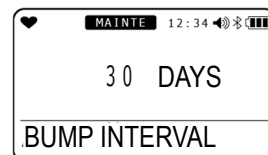

- 4 Press the **MODE** button.**

“END” appears and the display returns to the bump test setting menu.

NOTE

- If the setting exceeds 30 days, the SDM-3R may diagnose an abnormal value when connected to the SDM-3R docking station. In such a case, please set this setting to 30 days or less.

<Operation selection after bump test expiration>

This selects the operation after the bump test expiration date display.

- 1 Press the **AIR** button to select “BUMP SETTING”, then press the **MODE** button.**

The bump setting menu is displayed.

- 2 Press the **AIR** button to select “BUMP EXPIRED”, then press the **MODE** button.**

You can select the operation after bump test expiration.



- 3 Press the **AIR** button to select the operation after bump test expiration.**

Pressing the **AIR** button displays the following operations after bump test expiration:

- **CONFIRM TO USER:**
Action depends on the operation.
Press the **AIR** button to proceed to measurement mode. Press the **MODE** button to proceed to Bump test cylinder setting.
- **CANT USE:** Measurement mode is not available.
Press the **MODE** button or after 6 seconds without any operation to proceed to Bump test cylinder setting.
- **NO EFFECT:** Action depends on the operation.
After the indication that calibration has expired, press the **MODE** button to proceed to Bump test cylinder setting.
After 6 seconds without any operation, proceed to measurement mode automatically.



The default setting is “CONFIRM TO USER”.

- 4 Press the **MODE** button.**

“END” appears and the display returns to the bump test setting menu.

<Bump test gas selection>

Allows you to select the gas for which bump test expiration date is to be checked.

- 1 Press the **AIR** button to select “BUMP SETTING”, then press the **MODE** button.**

The bump setting menu is displayed.

- 2 Press the **AIR** button to select “BUMP CHECK GAS”, then press the **MODE** button.**

Allows you to select the gas for which bump test expiration date is to be checked.

- 3 Press the **AIR** button to select the bump test gas.**

Pressing the **AIR** button lets you select the gas for which bump test expiration date is to be checked.

- ALL GAS: All sensors
- 4GAS: All sensors other than the fourth slot

The default setting is “ALL GAS”.

- 4 Press the **MODE** button.**

“END” appears and the display returns to the bump test setting menu.

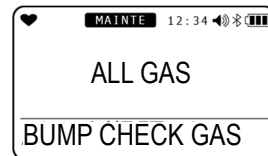

6-4-5. Man down alarm setting

This section describes “Man down alarm: ON/OFF”, “Panic alarm: ON/OFF”, and “Man down alarm time setting”.

NOTE

- Once setting is complete, press the **AIR** button to select “ESCAPE”, then press the **MODE** button. The display returns to the user mode menu.

<Man down alarm setting menu>

- Press the **AIR** button on the user mode menu to select “MAN DOWN”, then press the **MODE** button.

The man down alarm menu screen is displayed.



- Press the **AIR** button to select the required setting, then press the **MODE** button.



Setting item	LCD display	Reference page
MAN DOWN		<Man down alarm: ON/OFF> P. 66
PANIC		<Panic alarm: ON/OFF> P. 67
MAN DOWN TIME		<Man down alarm time setting> P. 67
ESCAPE		

<Man down alarm: ON/OFF>

This lets you enable and disable the man down alarm.

- Press the **AIR** button to select “MAN DOWN”, then press the **MODE** button.



- Press the **AIR** button to select ON or OFF for the man down alarm, then press the **MODE** button.

Pressing the **AIR** button lets you select ON or OFF for the man down alarm. The default setting is “OFF”.

“END” appears and the display returns to the man down alarm menu.



<Panic alarm: ON/OFF>

This lets you enable and disable the panic alarm.

- 1 Press the **AIR** button to select **"PANIC"**, then press the **MODE** button.



- 2 Press the **AIR** button to select **ON** or **OFF** for the panic alarm, then press the **MODE** button.

Pressing the **AIR** button lets you select ON or OFF for the panic alarm. The default setting is "OFF".

"END" appears and the display returns to the man down alarm menu.

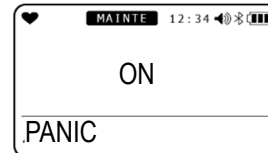
**<Man down alarm time setting>**

This lets you set the time before a man down alarm is triggered.

NOTE

- Set each alarm time within the following range:
10 seconds ≤ prealarm 1 ≤ prealarm 2 ≤ main alarm ≤ 240 seconds

- 1 Press the **AIR** button to select **"MAN DOWN TIME"**, then press the **MODE** button.



- 2 Press the **AIR** button to select the time for man down prealarm 1, then press the **MODE** button.

Pressing the **AIR** button lets you select the time for prealarm 1 in the range of 10 to prealarm 2 setting time. The default setting is "60 SEC".



- 3 Press the **AIR** button to select the time for man down prealarm 2, then press the **MODE** button.

Pressing the **AIR** button lets you select the time for prealarm 2 in the range of prealarm 1 setting time to main alarm setting time. The default setting is "75 SEC".

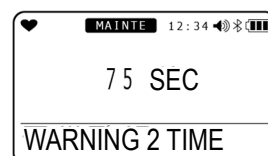

- 4 Press the **AIR** button to select the time for man down main alarm, then press the **MODE** button.

Pressing the **AIR** button lets you select the time for main alarm in the range of prealarm 2 setting time to 240 seconds. The default setting is "90 SEC".

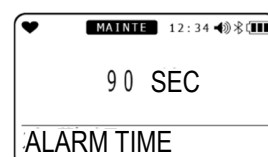

"END" appears and the display returns to the man down alarm menu.

6-4-6. Alarm setpoint setting

This section describes the settings for the first to third alarm setpoints, STEL alarm setpoint, and TWA alarm setpoint and how to restore the default settings.

<Alarm setpoint setting>

Alarm setpoints can be set in one-digit units.

Detection target gas	1 digit	Lower limit	Upper limit
Combustible gas (HC/CH ₄)	1 %LEL	1 %LEL (Recommended range 10%LEL or more)	60 %LEL
Carbon monoxide (CO)	1 ppm	12 ppm (Recommended range 25ppm or more)	2,000 ppm
Hydrogen sulfide (H ₂ S)	0.1 ppm	0.5 ppm (Recommended range 1.0ppm or more)	200.0 ppm
Sulfur dioxide (SO ₂)	0.05 ppm	0.25 ppm (Recommended range 1.00ppm or more)	100.00 ppm
Nitrogen dioxide (NO ₂)	0.05 ppm	0.50 ppm	20.00 ppm
Hydrogen cyanide (HCN)	0.1 ppm	0.9 ppm	30.0 ppm
Phosphine (PH ₃)	0.01 ppm	0.05 ppm	20.00 ppm
Ammonia (NH ₃)	0.5 ppm	8.0 ppm	400.0 ppm
Carbon dioxide (CO ₂)[vol%]	0.01 vol%	0.20 vol%	8.00 vol%
Carbon dioxide (CO ₂)[ppm]	20 ppm	1,000 ppm	10,000 ppm

Detection target gas	1 digit	First/second alarm		Third alarm	
		Lower limit	Upper limit	Lower limit	Upper limit
Oxygen (O ₂)	0.1 vol%	0.0 %	20.0 %	21.8 %	40.0 %

NOTE

- Set the alarm setpoints as follows:
First alarm ≤ second alarm ≤ third alarm (first alarm ≥ second alarm for oxygen)
- Use alarm settings within the range commensurate with the performance of the equipment. Setting alarm setpoints below the recommended range may cause false alarms.

- Press the **AIR** button on the user mode menu to select “ALARM SETTING”, then press the **MODE** button.**

The combustible sensor selection screen is displayed.



- Press the **AIR** button to select the gas type, then press the **MODE** button.**

Pressing the **AIR** button alternately displays the detection target gas and the alarm setpoint reset screen (page 69).

Pressing the **MODE** button displays the first alarm setpoint (WARNING) setting screen.

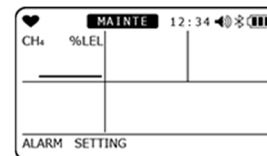

- Press the **AIR** button to select a numerical value for the first alarm setpoint, then press the **MODE** button.**

The second alarm setpoint (ALARM) setting screen is displayed.



- 4 Press the **AIR** button to select the second alarm setpoint numerical value, then press the **MODE** button.**
 The third alarm setpoint (ALARM H) setting screen is displayed.

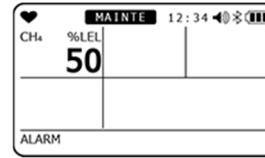

- 5 Press the **AIR** button to select the third alarm setpoint numerical value, then press the **MODE** button.**
 For toxic gases, the STEL and TWA setting screens are displayed after the above steps. Set these in the same way.
 "END" appears and the alarm setpoint reset screen appears.

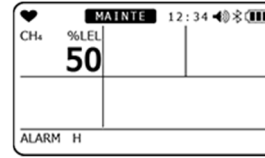

NOTE

- For information on how to reset settings, see "<Resetting alarm setpoints>" on page 69. The alarm setpoint reset screen may not appear if the product is not set correctly. If this occurs, contact RIKEN KEIKI.
- For more information on alarm setpoints, see "4 Alarm Activation" on page 20.

<Resetting alarm setpoints>

This restores alarm setpoints to their default settings.

- 1 Press the **AIR** button on the user mode menu to select "ALARM SETTING", then press the **MODE** button.**

The combustible sensor selection screen is displayed.



- 2 Press the **AIR** button several times.**
 The alarm setpoint reset screen is displayed.

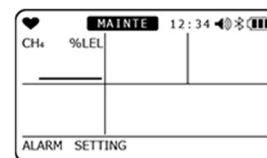

- 3 Press the **MODE** button.**
 The alarm setpoint reset setting screen is displayed.
 To cancel resetting, press the **AIR** button.

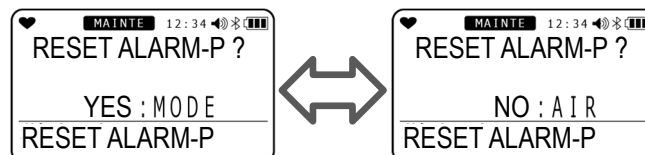

- 4 Press the **MODE** button.**
 The alarm setpoint reset confirmation screen is displayed.



5 Press the MODE button.

“END” appears and the display returns to the user mode menu.

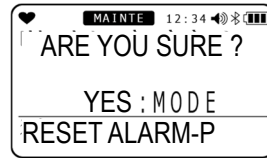

6-4-7. Lunch break: ON/OFF

This lets you enable and disable the lunch break function. The lunch break function retains the TWA and PEAK values from the last time the power was turned off and loads them to continue measurement the next time the power is turned on.

- 1 Press the **AIR** button on the user mode menu to select “LUNCH BREAK”, then press the **MODE** button.**

The lunch break setting screen is displayed.



- 2 Press the **AIR** button to select ON or OFF for the lunch break function.**

Pressing the **AIR** button lets you select ON or OFF for the lunch break function. The default setting is “OFF”.

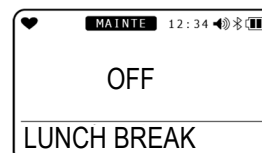

- 3 Press the **MODE** button.**

“END” appears and the display returns to the user mode menu.

NOTE

- When the lunch break setting is enabled, a confirmation screen is displayed asking the user whether to retain the TWA and PEAK values from the last time the power was turned off and continue measurement or to reset the values when the power is turned on.

6-4-8. Confirmation beep setting

This function provides an audible indication of whether the product is operating normally.

The buzzer sounds at preset intervals while measurement is underway. The following functions can also be operated with "BUMP / CAL", "ALM ALRT" and "B / C / ALM".

1. BUMP/CAL

- Starts operation when calibration deadline setting is ON and or calibration is expired, or bump deadline setting is ON and bump is expired.
- Once the operation is starts, it does not stop until all loaded gases are calibrated or bumped. (Except H2 cancellation)
- Every interval setting time The LED lights up for about one second.

2. ALM ALRT

- Starts operation when a gas alarm is issued. (Including minus sensor failure)
- Once the operation is starts, it does not stop until all loaded gases are calibrated or bumped. (Except H2 cancellation)
- Every interval setting time The LED lights up for about one second.

3. B/C/ALM

- Starts operation when calibration deadline setting is ON and or calibration is expired, or bump deadline setting is ON and bump is expired.
- Once the operation is starts, it does not stop until all loaded gases are calibrated or bumped. (Except H2 cancellation)
- Every interval setting time The LED lights up for about one second.

<Confirmation beep setting menu>

- 1 Press the **AIR** button on the user mode menu to select “CONFIRMATION”, then press the **MODE** button.**

The confirmation beep menu screen is displayed.



- 2 Press the **AIR** button to select the required setting, then press the **MODE** button.**

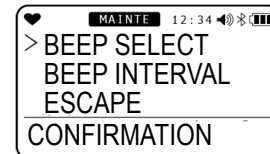

Setting item	LCD display	Reference page
BEEP SELECT		<Beep operation setting> P. 72
BEEP INTERVAL		<Beep interval setting> P. 72
ESCAPE		

NOTE

- Once setting is complete, press the **AIR** button to select “ESCAPE”, then press the **MODE** button. The display returns to the user mode menu.

<Beep operation setting>

This lets you set the confirmation beep operation.

- 1 Press the **AIR** button to select “BEEP SELECT”, then press the **MODE** button.**

The beep operation selection screen is displayed. However, if you change the setting, the operations of "BUMP / CAL", "ALARM ALERT" and "BUMP / CAL / ALARM" will stop.



- 2 Press the **AIR** button.**

Pressing the **AIR** button displays the following screens in sequence:

- “OFF”
- “LED”
- “BUZZER”
- “LED+BUZZER”
- “BUMP/CAL”
- “ALARM ALERT”
- “BUMP/CAL/ALARM”

The default setting is “OFF”.

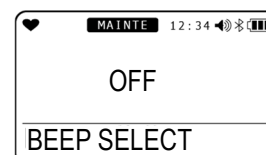

- 3 Press the **MODE** button.**

“END” appears and the display returns to the confirmation beep setting menu.

<Beep interval setting>

This lets you set the interval between confirmation beeps.

- 1 Press the **AIR** button to select “BEEP INTERVAL”, then press the **MODE** button.**

The beep interval setting screen is displayed.



- 2 Press the **AIR** button.**

Pressing the **AIR** button lets you select the beep interval from a choice of 0.5 minutes and from 1 to 99 minutes. The default setting is “5 MIN”.

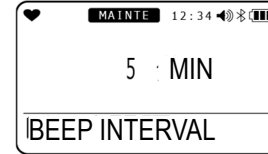

- 3 Press the **MODE** button.**

“END” appears and the display returns to the confirmation beep setting menu.

6-4-9. Automatic backlight: ON/OFF

This enables and disables the function to automatically illuminate the backlight on the LCD display. When enabled, the backlight will automatically go on in dark locations.

- 1 Press the **AIR** button on the user mode menu to select “AUTO BACKLIGHT”, then press the **MODE** button.**
The backlight setting screen is displayed.



- 2 Press the **AIR** button to select ON or OFF for the backlight.**
Pressing the **AIR** button lets you select ON or OFF for the backlight. The default setting is “ON”.

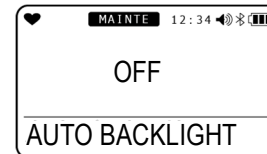

- 3 Press the **MODE** button.**
“END” appears and the display returns to the user mode menu.

6-4-10. Backlight lighting time setting

This lets you set the duration for which the LCD backlight remains lit.

- 1 Press the **AIR** button on the user mode menu to select “BACKLIGHT TIME”, then press the **MODE** button.**
The backlight lighting time setting screen is displayed.



- 2 Press the **AIR** button to select the backlight lighting time.**
Pressing the **AIR** button lets you select a backlight lighting time of OFF or 1 to 255 seconds. The default setting is “30 SEC”.



- 3 Press the **MODE** button.**
“END” appears and the display returns to the user mode menu.

6-4-11. Key tone: ON/OFF

This enables and disables the key operation tone.

- 1 **Press the **AIR** button on the user mode menu to select “KEY TONE”, then press the **MODE** button.**

The key tone setting screen is displayed.

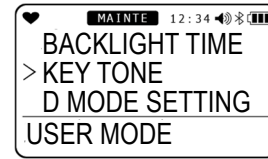

- 2 **Press the **AIR** button to select ON or OFF for the key tone.**

Pressing the **AIR** button lets you select ON or OFF for the key tone. The default setting is “ON”.



- 3 **Press the **MODE** button.**

“END” appears and the display returns to the user mode menu.

6-4-12. Display mode item display: ON/OFF

This lets you set whether the display mode items that can be set are displayed or hidden.

When set to OFF, the following items are not displayed in display mode:

- Combustible gas conversion setting
- Long-life battery setting
- LCD inversion setting
- LCD background inversion
- Bluetooth setting
- Buzzer volume adjustment function
- Display language change

- 1 **Press the **AIR** button on the user mode menu to select “D MODE SETTING”, then press the **MODE** button.**

The display mode item display setting screen is displayed.

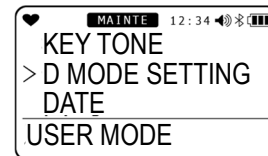

- 2 **Press the **AIR** button to select ON or OFF for the display mode item display.**

Pressing the **AIR** button lets you select ON or OFF for the display mode item display.

The items listed above will not be displayed if this is set to “OFF”.

The default setting is “ON”.

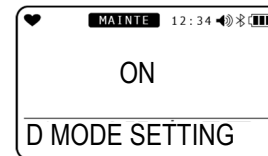

- 3 **Press the **MODE** button.**

“END” appears and the display returns to the user mode menu.

6-4-13. CO₂ sensor unit selection

This lets you select the units used with the CO₂ sensor.
This setting is displayed only on models that detect CO₂.

- 1 **Press the **AIR** button on the user mode menu to select “IR UNIT SELECT”, then press the **MODE** button.**

The CO₂ sensor unit selection screen is displayed.



- 2 **Press the **AIR** button to select the unit for the CO₂ sensor.**

Pressing the **AIR** button displays the following screens alternately:

- vol%
- ppm

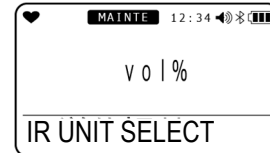

- 3 **Press the **MODE** button.**

“END” appears and the display returns to the user mode menu.

6-4-14. CO₂ sensor air calibration: ON/OFF

This sets whether or not the CO₂ sensor is subject to air calibration. Setting to ON calibrates the CO₂ sensor when air calibration is performed.

This is displayed only on models that detect CO₂.

- 1 **Press the **AIR** button on the user mode menu to select “CO2AIR SETTING”, then press the **MODE** button.**

The CO₂ sensor air calibration setting screen is displayed.

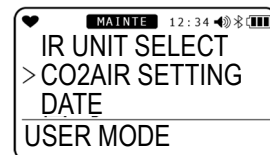

- 2 **Press the **AIR** button to select ON or OFF for CO₂ sensor air calibration.**

Pressing the **AIR** button lets you select ON or OFF for the CO₂ sensor air calibration.
The default setting is “OFF”.



- 3 **Press the **MODE** button.**

“END” appears and the display returns to the user mode menu.

NOTE

This may not be displayed depending on the setting and connection status.

CO₂ sensor connected normally: Displayed

CO₂ sensor not connected normally or set to a sensor other than CO₂ sensor: Not displayed

6-4-15. Date and time setting

This sets the date and time for the internal clock.

- 1 **Press the **AIR** button on the user mode menu to select “DATE”, then press the **MODE** button.**

The date and time setting screen is displayed.
The item currently blinking can be set.

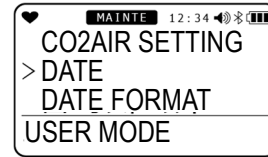

- 2 **Press the **AIR** button to select the required setting item, then press the **MODE** button.**

Set the date and time in the sequence year -> month -> day -> hour -> minute.

- YYYY (year)
- MM (month)
- DD (day)
- 0:00 (time)

Press the **MODE** button after setting the “minute” item. “END” appears and the display returns to the user mode menu.

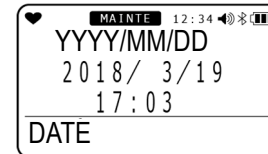

6-4-16. Date format setting

This lets you select one of three different date formats.

- 1 **Press the **AIR** button on the user mode menu to select “DATE FORMAT”, then press the **MODE** button.**

The date format setting screen is displayed.

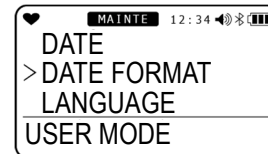

- 2 **Press the **AIR** button to select the desired format.**

The following formats are available:

- “YYYY/MM/DD” (year/month/day)
- “DD/MM/YYYY” (day/month/year)
- “MM/DD/YYYY” (month/day/year)

The default setting is “MM/DD/YYYY” for ATEX/IECEX specification.

- 3 **Press the **MODE** button.**

“END” appears and the display returns to the user mode menu.

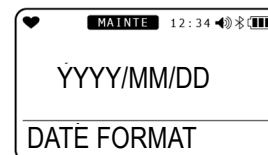

6-4-17. Language setting

This lets you select one of thirteen different languages for the LCD display.

- 1 Press the **AIR** button on the user mode menu to select “LANGUAGE”, then press the **MODE** button.**

The language setting screen is displayed.

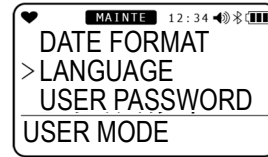

- 2 Press the **AIR** button to select the desired language.**

The following languages are available:

- ENGLISH
- JAPANESE
- ITALIAN
- SPANISH
- GERMAN
- FRENCH
- PORTUGUESE
- RUSSIAN
- VIETNAMESE
- POLISH
- TURKISH
- ROMANIAN
- CZECH



The default setting is “ENGLISH” for ATEX/IECEX specification.

- 3 Press the **MODE** button.**

“END” appears and the display returns to the user mode menu.

6-4-18. User password setting

This lets you set a password for accessing user mode. The password can be set as a four-digit number in the range 0000 to 9999.

- 1 Press the **AIR** button on the user mode menu to select “USER PASSWORD”, then press the **MODE** button.**

The password can be enabled or disabled on the user mode password setting screen.

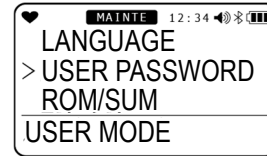

- 2 Press the **AIR** button to select “ON”, then press the **MODE** button.**

The password input screen is displayed. The default setting is “0000”.

The password can be set as a four-digit number in the range 0000 to 9999.

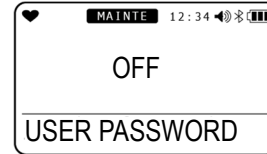

- 3 Press the **AIR** button to select a number from 0 to 9, then press the **MODE** button.**

The number is input as the first digit of the password and the second digit blinks.



Press the **MODE** button after entering the final digit. “END” appears and the display returns to the user mode menu.

<Accessing user mode when password-protected>

- 1 With the power turned off, press the **AIR** button and **POWER** button at the same time.**

Release the buttons when the buzzer blips. The password input screen is displayed.

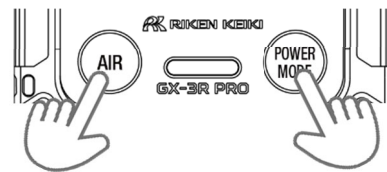

- 2 Enter the preset password.**

Press the **AIR** button to select the number for the currently selected digit, then press the **MODE** button to confirm.



The user mode menu is displayed once the password has been correctly entered. If the password entered is incorrect, an error is displayed. The display switches to “Screen transition from powering on to displaying measurement screen” in “5-3. Startup”.

6-4-19. ROM/SUM display

This displays the program number and SUM value of the product.

* This is not normally used by the user.

- 1 **Press the **AIR** button on the user mode menu to select “ROM/SUM”, then press the **MODE** button.**

The ROM/SUM screen is displayed.

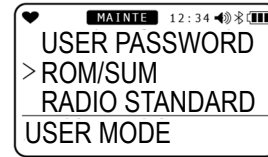

The following information is displayed alternately on the ROM/SUM screen.

- “ROM/SUM MAIN”
- “ROM/SUM SENSOR”
- “ROM/SUM IR SENS”
 - * Only on models with CO₂ sensor
- “BLUETOOTH”

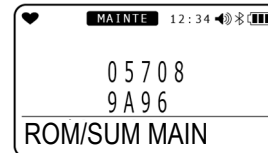

- 2 **Press the **MODE** button.**

“END” appears and the display returns to the user mode menu.

6-4-20. Bluetooth authentication display

This lets you check Bluetooth authentication.

- 1 **Press the **AIR** button on the user mode menu to select “RADIO STANDARD”, then press the **MODE** button.**

Bluetooth authentication is displayed.



The authentication code is displayed in the area.

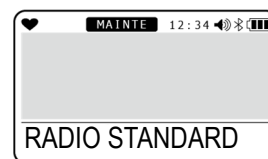

- 2 **Press the **MODE** button.**

“END” appears and the display returns to the user mode menu.

NOTE

This is not displayed on certain models.

Bluetooth equipped: Displayed

Bluetooth not equipped: Not displayed

7

Maintenance

The product is an important safety and disaster-prevention device. Maintain the product at regular intervals to ensure performance and improve disaster-prevention and safety reliability.

7-1. Maintenance intervals and maintenance items

The following items should be maintained regularly before using the product:

- Daily maintenance: Perform maintenance before commencing work.
- Monthly maintenance: Perform maintenance by testing the alarms once a month.
- Regular maintenance: Perform maintenance at least once a year (ideally, at least once every six months).

Maintenance item	Maintenance details	Daily maintenance	Monthly maintenance	Regular maintenance
Battery level	Check to confirm that battery levels are adequate.	○	○	○
Concentration display	Check to confirm that the concentration readout is 0 (or 20.9 % for oxygen meter) after drawing in fresh air. If the readout is not 0, check to confirm that that no interference gases are present, then perform air calibration.	○	○	○
Main unit operation	Check the LCD display to confirm that the readout is not faulty.	○	○	○
Filter	Check to confirm that the filter is not dirty.	○	○	○
Alarm test	Test the alarm and check to confirm that the alarm LED arrays, buzzer, and vibrator all operate correctly.	–	○	○
Span adjustment	Perform span adjustment using a calibration gas.	–	–	○
Gas alarm check	Check the gas alarm with a calibration gas.	–	–	○



WARNING

- If an abnormality is discovered in the product, contact RIKEN KEIKI immediately.

NOTE

- Span adjustment requires dedicated tools and preparation of a calibration gas. Always contact RIKEN KEIKI for span adjustment.
- The built-in sensors have finite service lives and must be replaced regularly.
- If the sensors cannot be calibrated using span adjustment, the readings are not restored after air calibration, or the readings fluctuate, the sensors are at the end of their life. Contact RIKEN KEIKI for replacement.

Maintenance service

RIKEN KEIKI provides services related to regular maintenance including span adjustment, as well as other adjustments and maintenance.

Preparing calibration gas requires the use of dedicated tools, such as gas cylinders of the specified concentration and gas sampling bags.

Our certified service engineers have expert knowledge of the dedicated tools used for these services, along with expertise in products. Please take advantage of the RIKEN KEIKI maintenance service to maintain safe operation of the product.

The maintenance service covers the following main aspects. Please contact RIKEN KEIKI for more information.

<Main maintenance service details>

Battery level check	Checking battery levels
Concentration display check	Checks to confirm that the concentration readout is 0 (or 20.9 % for oxygen meter) using a zero gas. Air calibration (zero adjustment) is performed if the reading is not zero.
Filter check	Checks the dust filter for contamination and clogging. The filter is replaced if dirty or clogged.
Alarm test	Tests the alarm to check to confirm that the alarm LEDs, buzzer, and vibrator all operate correctly.
Span adjustment	Performs span adjustment using a calibration gas.
Gas alarm check	Checks the gas alarm using a calibration gas. <ul style="list-style-type: none"> • Checking alarms (confirming alarm activation when alarm setpoint is reached) • Checking delay time (checking delay time until alarm activation) • Checks the buzzer, LEDs, vibrator, and concentration display. (Checks operation for each of the three-step alarms.)
Product cleaning and repair (visual inspection)	Checks the exterior of the product for dirt and damage; cleans and repairs any prominent problem areas. Parts are replaced if cracked or damaged.
Product operation check	Operates the buttons to check function operations and parameters.
Consumable part replacement	Replaces degraded components such as sensors and filters.

7-2. Calibration

The product can be calibrated using automatic calibration with preset gas concentrations in addition to air calibration.

Span adjustment requires dedicated tools and a calibration gas. Contact RIKEN KEIKI.



CAUTION

- Do not use lighter gas to check the sensitivity of the product. Constituents in the lighter gas may degrade sensor performance.
- When equipped with a carbon dioxide (CO₂) sensor, it may show a high indication immediately after energization due to the characteristics of the sensor
You Warm it up for about 10 to 20 minutes and use it after instructions are stable.
- When an ammonia (NH₃) sensor is installed, the indication may rise temporarily immediately after the sensor is energized due to its characteristics. When replacing the battery before it runs out, please wait at least 10 minutes before turning the power back on. Also, when the sensor is replaced, the battery is replaced because it is dead, or the battery is removed and has not been used for a long period of time, turn the power back on after 120 minutes or more.

7-2-1. Preparation for calibration

This section describes how to calibrate the product using calibration adapter (simple type).

<Required equipment/materials>

- Calibration gas
- Gas sampling bag
- Calibration adapter (simple type) *ATEX/IECEX specification is shipped with this parts.
- Pump

<Recommended calibration gas concentrations>*

Detection target gas	Sensor model	Calibration gas	Calibration gas concentration
Combustible gas (HC)	NCR-6309	Isobutane (i-C ₄ H ₁₀)	50 %LEL (0.7 vol%)
Combustible gas (CH ₄)	NCR-6309	Methane (CH ₄)	50 %LEL (2.2 vol%)
Hydrogen sulfide (H ₂ S)	ESR-A1DP or ESR-A13i	Hydrogen sulfide (H ₂ S)	25.0 ppm
Oxygen (O ₂)	ESR-X13P	Oxygen (O ₂) N ₂ diluted	12.0 %
Carbon monoxide (CO)	ESR-A1DP or ESR-A1CP or ESR-A13P	Carbon monoxide (CO)	50 ppm
Carbon monoxide (CO)	ESR-A1CP	Hydrogen (H ₂) air diluted	500 ppm
Sulfur dioxide (SO ₂)	ESR-A13D	Sulfur dioxide (SO ₂) N ₂ diluted	8.00 ppm
Nitrogen dioxide (NO ₂)	ESR-A13D	Nitrogen dioxide (NO ₂) air diluted	4.80 ppm

Hydrogen cyanide (HCN)	ESR-A13D	Hydrogen cyanide (HCN)	8.0 ppm
		Phosphine (PH ₃) (substitute gas)	0.5 ppm (PH ₃ concentration x conversion factor = HCN concentration)
Phosphine (PH ₃)	ESR-A13D2	Phosphine (PH ₃)	0.50 ppm
Ammonia (NH ₃)	ESR-B134	Ammonia (NH ₃)	40.0 ppm
Carbon dioxide (CO ₂)	IRR-0409	Carbon dioxide (CO ₂)	2.5 vol%
		Nitrogen	99.999%
Carbon dioxide (CO ₂)	IRR-0433	Carbon dioxide (CO ₂)	5,000 ppm
		Nitrogen	99.999%

* The same applies to bump test gas.

NOTE

- Do not perform gas calibration and bump test using the conversion gas, even when using the combustible gas conversion function. Gas calibration and bump tests should always be performed using the calibration gases listed in the table above.

<Gas supply method>

Attach a calibration adapter (simple type) to the product, connect the gas sampling bag as shown in the figure below to introduce gas at a flow rate of 250 mL/min, and wait 60 seconds (120 seconds for ammonia (NH₃) sensor) after the reading increases before calibrating.

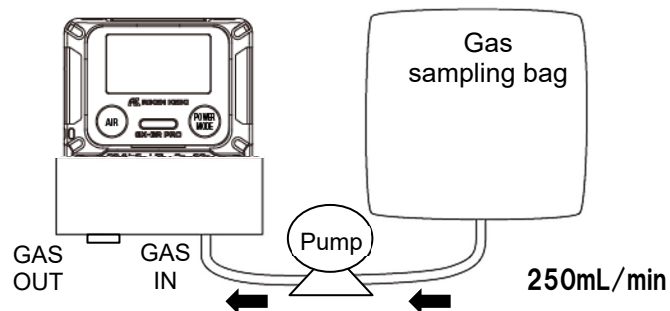



WARNING

Calibration gas

The calibration gas is a hazardous gas (e.g., combustible gas, toxic gas, oxygen deficiency). Handle the gas and related jigs and tools with due care.

Gas sampling bag

Use different gas sampling bags for each gas type and concentration to ensure accurate calibration.

Calibration location

- Do not calibrate in a confined space.
- Do not calibrate in locations where gases such as silicone and spray can gases are used.
- Calibrate indoors at normal temperatures with no significant fluctuations (within ± 5 °C).

Carbon monoxide sensor (ESR-A1CP) calibration

- The carbon monoxide sensor with hydrogen interference correction function (ESR-A1CP) must be calibrated separately for carbon monoxide and hydrogen.
- The carbon monoxide and hydrogen used for calibration must each be a single gas. Calibration can be performed using a gas mixture, but correct span adjustment will not be achieved, and concentration readings will be inaccurate.
- If hydrogen sensitivity is not calibrated, carbon monoxide readings may be slightly higher or lower than actual concentrations when measured in environments where hydrogen is also present.

Hydrogen cyanide sensor (ESR-A13D) calibration

- Use a calibration gas that contains hydrogen cyanide diluted with air or phosphine diluted with nitrogen or air as a standard gas. Calibration can be performed with gases containing other components, but they cannot be calibrated to the correct sensitivity and will not give accurate concentration readings.
- When performing calibration with substitute gas (PH_3), remove the interference gas removal filter (CF-A13D-2). For details on how to remove the filter, see Section 7-5-2, "Filter replacement".
- When calibrating with substitute gas (PH_3), calculate the value of the calibration gas concentration by multiplying the PH_3 concentration by the conversion factor (PH_3 concentration x conversion factor = HCN concentration). The conversion factor is printed on the side of the sensor to the right of the sensor model. For removal of the sensor, refer to Section 7-5-2, "Filter replacement".

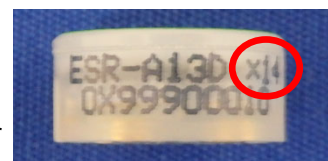

Conversion Factor Print Image
(Example: 14)



CAUTION

- When supplying gas, leave the GAS OUT side open and discharge the supplied gas to a safe place, or connect the gas sampling bag to the GAS OUT side to recover the supplied gas.
- If it is used and stored for a long time in a dry environment, the hydrogen gas sensitivity calibration may not be possible. If FAIL SENSOR is displayed at the time of hydrogen gas sensitivity calibration, release the main body overnight or more in an environment with sufficient humidity. Please install again and perform gas calibration again. However, if CO gas sensitivity calibration can not be performed, please contact your dealer or our nearest sales office for sensor replacement.

NOTE

- RP-3R (option) or SDM-3R (option) can also be used for calibration in addition to the methods described above.
To use RP-3R (option), the pump mode should be set to Low mode.

7-2-2. Calibration setting menu

This section describes “Air calibration”, “Auto calibration concentration setting”, “Auto calibration cylinder setting”, “Auto calibration”, and “CO₂ zero calibration”.

- 1 Press the AIR button on the user mode menu to select “GAS CAL”, then press the MODE button.**

The calibration menu screen is displayed.



- 2 Press the AIR button to select the required setting, then press the MODE button.**



Setting item	LCD display	Reference page
AIR CAL	<p>MAINT 12:34 [Battery Icon] [Signal Icon]</p> <p>> AIR CAL CO2 ZERO CAL AUTO CAL GAS CAL</p>	“7-2-3. Air calibration” P.87
CO2 ZERO CAL * Displayed only on models that detect CO ₂ . May not be displayed if the CO ₂ sensor is not connected correctly.		“7-2-4. CO2 zero calibration” P. 89
AUTO CAL		“7-2-5. Auto calibration” P.90 “7-2-6. Switch from AUTO calibration to measurement start screen” P.91 “7-2-7. Auto calibration cylinder setting” P. 92 “7-2-8. Auto calibration gas concentration selection” P. 93
ESCAPE		

NOTE

- Once setting is complete, press the AIR button to select “ESCAPE”, then press the MODE button. The display returns to the user mode menu.

7-2-3. Air calibration



WARNING

- When air calibration is performed in the atmosphere, check the atmosphere for freshness before starting. The presence of interference gases will make it impossible to perform zero adjustment correctly and potentially result in hazardous conditions in the event of actual gas leaks.



CAUTION

- Always perform air calibration under conditions of pressure, temperature, and humidity similar to those in the operating environment and in fresh air.
- Wait for the readout to stabilize before performing air calibration.
- By default, air calibration is not performed on the CO₂ sensor. You can enable air calibration for the CO₂ sensor by setting the CO₂ sensor air calibration setting to ON in user mode. For information on how to change the setting, see “6-4-14. CO₂ sensor air calibration: ON/OFF” on page 76. Air calibration adjusts to 400 ppm. Confirm that the surrounding air is fresh. Note that the product will not perform to standard product specifications if you perform air calibration with this setting. If CO₂ air calibration is performed successfully, the CO₂ zero calibration value is deleted and set to 400 ppm.
- If the temperature between the storage and use locations changes rapidly by 15°C or more, acclimate the sensor in the same environment as the use location for about 10 minutes (about 30 minutes for ammonia (NH₃) sensors) with the power turned on, and perform air calibration in fresh air before use.

NOTE

- If air calibration fails, “FAIL” appears next to the measurement for the faulty sensor together with “SENSOR”. Press the **MODE** button to reset the fault alarm (calibration failure). Air calibration will not be performed for the faulty sensor and the concentration will be calculated using the value before calibration.
- Air calibration can also be performed in measurement mode. (P. 33)
- When using the combustible gas conversion function with the long-life battery setting ON, in principle, the indicated value may rise temporarily after power-on, and depending on the alarm setting value, a gas alarm may be issued. Please wait about 5 minutes after power-on and perform air calibration before use.
In particular, Toluene, Xylene, N-nonane, or Methyl isobutyl ketone tend to rise comparatively, so it is recommended to use the product with the long-life battery setting OFF.

- Press the **AIR** button to select “AIR CAL”, then press the **MODE** button.**

The air calibration screen is displayed.



- Hold down the **AIR** button.**

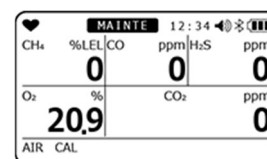

Air calibration is performed.

3 Release the button when “RELEASE” is displayed.

“PASS” is displayed if air calibration was successful.

The current concentration after air calibration appears. The display returns to the calibration menu screen.

“FAIL” is displayed if calibration was unsuccessful.
“END” appears and the display returns to the calibration menu screen.

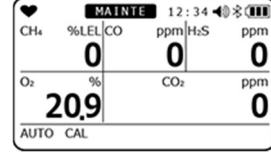
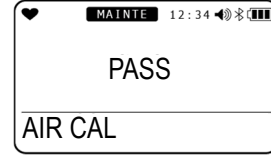
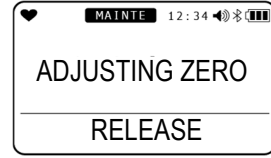

7-2-4. CO₂ zero calibration



WARNING

- Use high purity air or nitrogen for zero calibration of the carbon dioxide sensor.

- 1 Press the **AIR** button to select “CO₂ ZERO CAL”, then press the **MODE** button.**

The CO₂ zero calibration screen is displayed.



- 2 After introducing high purity air or nitrogen push the **MODE** button after 60 seconds.**

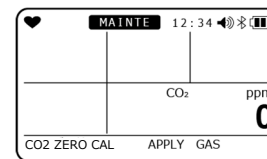

CO₂ zero calibration is performed.



“PASS” is displayed if CO₂ zero calibration was successful.

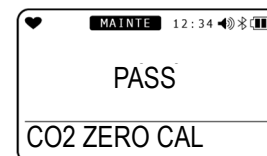

The current concentration after CO₂ zero calibration appears. The display returns to the calibration menu screen.

“FAIL” is displayed if calibration was unsuccessful.
“END” appears and the display returns to the calibration menu screen.

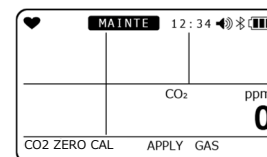

NOTE

- If air calibration of the CO₂ sensor is enabled in user mode, the CO₂ zero calibration value is deleted and set to 400 ppm when air calibration is successful.
- If CO₂ air calibration is performed successfully, the 400 ppm calibration value is deleted and set to 0 ppm.

7-2-5. Auto calibration

This calibrates for each gas at the specified concentration.



WARNING

- When calibrating the hydrogen cyanide sensor (ESR-A13D) with substitute gas (phosphine), remove the interference gas removal filter (CF-A13D-2) and perform calibration. For details on how to replace the filter, refer to Section 7-5-2, "Filter replacement".

1 Press the **AIR button to select "AUTO CAL", then press the **MODE** button.**

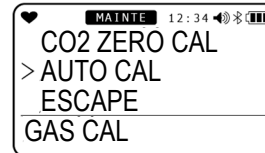

2 Select the cylinder for calibration, then press the **MODE button.**

For information on cylinder settings, see "7-2-7. Auto calibration cylinder setting" on page 92.

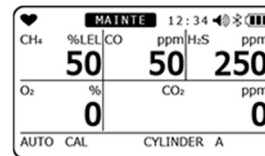

3 Introduce the calibration gas, wait 60 seconds, and then press the **MODE button.**

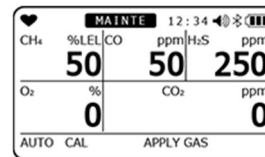

Auto calibration is performed.



"PASS" is displayed if air calibration was successful.
"FAIL" is displayed if calibration was unsuccessful.



The concentration after auto calibration is displayed.

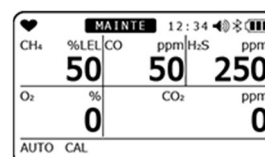

Moves to the measurement start screen.

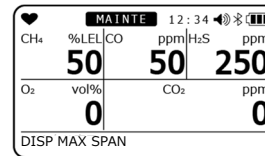

WARNING

- For models with a combustible gas sensor installed, the screen shown on the right may be displayed after auto calibration. When the screen shown on the right is displayed, the alarm is automatically cleared by pressing the **MODE** button or after 5 seconds.
- The screen shown on the right is displayed when the combustible gas sensor is poisoned by silicone compounds, halides, or other substances. When the screen shown on the right is displayed, the combustible gas conversion function can be used only for the gas types marked with "O" in the "Conversion when conversion is restricted" column in the "Conversion gas list" section of "6-2-2. Combustible gas conversion setting." If you wish to continue to use the combustible gas conversion function for gas types marked with "x", please contact RIKEN KEIKI.

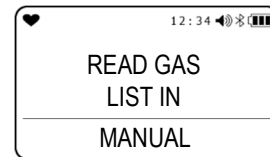

NOTE

- If a CO₂ sensor is installed, always perform CO₂ zero calibration before auto calibration.
Air calibration → CO₂ zero calibration → auto calibration
- For gases other than CO₂, air calibration must always be performed before auto calibration.

7-2-6. Switch from AUTO calibration to measurement start screen

In this section, it explains about switchment from AUTO calibration to measurement start screen.

- 1 Press the **AIR** button and select "AUTO CAL" and press the **MODE** button.**

AUTO calibration screen is displayed.



- 2 Press the **AIR** button and select "START MEASURE".**

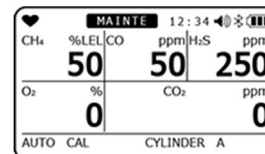

- 3 Press the **MODE** button.**

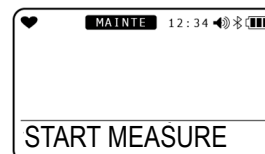

The LCD lights up completely and will move to the measurement start screen.

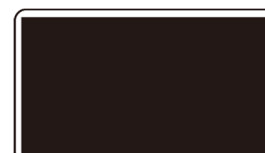

7-2-7. Auto calibration cylinder setting

This section describes how to set gas groups (cylinders) for calibration. Five gas cylinders can be set as A to E.

- 1 Press the AIR button to select “AUTO CAL”, then press the MODE button.**
The auto calibration screen is displayed.

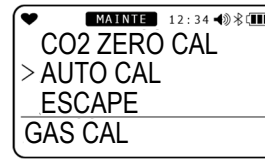

- 2 Press the AIR button.**
Pressing the AIR button displays the gas type and concentration for cylinders A to E in sequence.

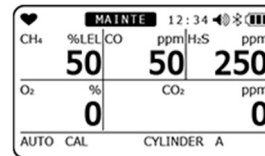

- 3 Select “CYL SETTING”, then press the MODE button.**



- 4 Press the AIR button.**
Pressing the AIR button displays the detection target gas in sequence.
Pressing the AIR button once more displays “ESCAPE” and returns the display to the screen in Step 1.

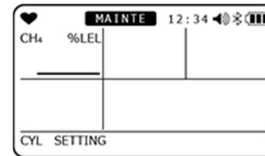

- 5 Press the MODE button on the sensor selection screen for changing cylinder settings.**
The cylinder setting change screen is displayed.

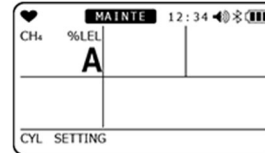

- 6 Press the AIR button to select a cylinder from A to E, then press the MODE button.**
“END” appears and the display returns to the calibration menu screen.

7-2-8. Auto calibration gas concentration selection

This section describes how to select the auto calibration gas concentration for the sensors installed. Calibration gas concentration can be set in one-digit units within the setting range.

<Calibration gas concentration setting range>

Detection target gas	Sensor model	Calibration gas	1 digit	Lower limit	Upper limit
Combustible gas (HC)	NCR-6309	Isobutane (i-C ₄ H ₁₀)	1 %LEL	1 %LEL	75 %LEL
Combustible gas (CH ₄)	NCR-6309	Methane (CH ₄)	1 %LEL	1 %LEL	75 %LEL
Hydrogen sulfide (H ₂ S)	ESR-A1DP or ESR-A13i	Hydrogen sulfide (H ₂ S)	0.1 ppm	0.5 ppm	200.0 ppm
Oxygen (O ₂)	ESR-X13P	Oxygen (O ₂)	0.1 vol%	0.0 vol%	18.0 vol%
Carbon monoxide (CO)	ESR-A1DP or ESR-A1CP* or ESR-A13P	Carbon monoxide (CO)	1 ppm	12 ppm	2,000 ppm
Carbon monoxide (CO)	ESR-A1CP*	Hydrogen (H ₂)**	1 ppm	25 ppm	2,000 ppm
Sulfur dioxide (SO ₂)	ESR-A13D	Sulfur dioxide (SO ₂)	0.05 ppm	0.25 ppm	100.00 ppm
Nitrogen dioxide (NO ₂)	ESR-A13D	Nitrogen dioxide (NO ₂)	0.05 ppm	0.50 ppm	20.00 ppm
Hydrogen cyanide (HCN)***	ESR-A13D	Hydrogen cyanide (HCN)	0.1 ppm	0.9 ppm	30.0 ppm
Phosphine (PH ₃)	ESR-A13D2	Phosphine (PH ₃)	0.01 ppm	0.05 ppm	20.00 ppm
Ammonia (NH ₃)	ESR-B134	Ammonia (NH ₃)	0.5 ppm	8.0 ppm	400.0 ppm
Carbon dioxide (CO ₂)	IRR-0409	Carbon dioxide (CO ₂)	0.01 vol%	0.20 vol%	4.00 vol%
Carbon dioxide (CO ₂)	IRR-0433	Carbon dioxide (CO ₂)	20 ppm	1,000 ppm	10,000 ppm

* CO(-H₂) calibration should be performed using single gas and not as a mixture of CO and H₂.

** Hydrogen must be calibrated in the range 10 °C to 30 °C.

*** When calibrating the hydrogen cyanide sensor with PH₃ (substitute gas), refer to "7-2-1. Preparation for calibration" for calibration gas concentration values. The sensor must be calibrated in the range of 10°C to 30°C

- 1 Press the AIR button to select "AUTO CAL", then press the MODE button.**

The auto calibration screen is displayed.



- 2 Press the AIR button.**

Pressing the AIR button displays the concentrations for cylinders A to E in sequence.

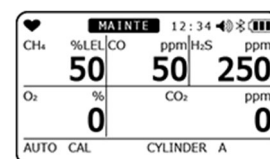

- 3 **Select “SETTING CAL-P”, then press the **MODE** button.**

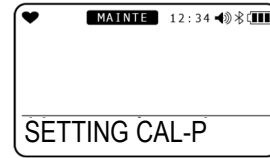

- 4 **Press the **AIR** button to select the calibration gas type.**

Pressing the **AIR** button displays the detection target gas in sequence.

Pressing the **AIR** button once more displays “ESCAPE” and returns the display to the screen in Step 1.

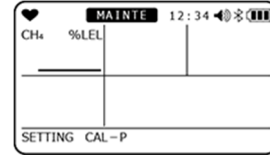

- 5 **Press the **MODE** button on the sensor selection screen for changing calibration gas concentrations.**

The calibration concentration change screen is displayed.

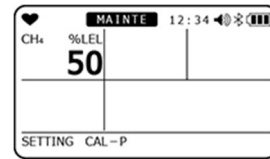

- 6 **Press the **AIR** button to select the calibration concentration, then press the **MODE** button.**

“END” appears and the display returns to the calibration menu screen.

7-3. Bump test

The product includes a function for performing a bump test (function check).

7-3-1. Perform bump test (BUMP TEST)

A bump test can be performed for gas types selected from cylinders A to E. Prepare a bump test gas in the same way as for the calibration gas (P. 83).



WARNING

- When performing a bump test of the hydrogen cyanide sensor (ESR-A13D) with an substitute gas (phosphine), remove the interference gas removal filter (CF-A13D-2) and perform calibration. See Section 7-5-2 "Filter Replacement" for filter replacement. For information on the concentration of the bump test gas, refer to "7-2-1 Preparation for calibration".

- 1 **Press the **AIR** button on the user mode menu to select “BUMP TEST”, then press the **MODE** button.**
The bump test screen is displayed.



- 2 **Press the **AIR** button to select the cylinder for the bump test.**

Cylinders A to E are displayed in sequence.

Pressing the **AIR** button once more displays “ESCAPE” and returns the display to the screen in Step 1.

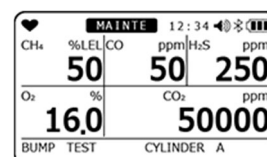

3 Press the **MODE button on the screen displaying the cylinder.**

Introduce the gas for the bump test.
The bump test is performed.

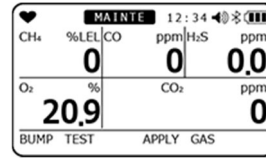

If calibration is specified to be performed after a bump test fails, calibration will be automatically performed if the bump test fails.

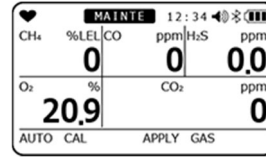

After the bump test and calibration are completed, the bump test results (left), calibration results (right) are displayed together with the readings at the bump test and after calibration.

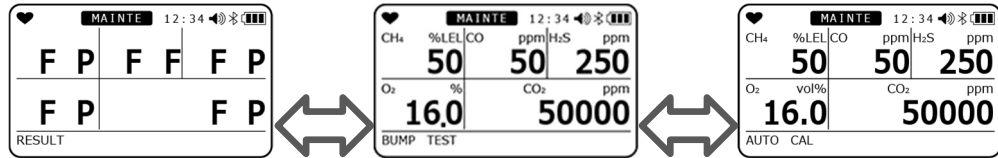

“P”: Passed, “F”: Failed

(Only those calibrated are displayed.)

3 Press the **MODE button.**

“END” appears and the display returns to the measurement start screen.



CAUTION

- For models with a combustible gas sensor installed, the screen shown on the right may be displayed if calibration is performed after a bump test failure. When the screen shown on the right is displayed, the alarm is automatically cleared by pressing the **MODE** button or after 5 seconds.
- The screen shown on the right is displayed when the combustible gas sensor is poisoned by silicone compounds, halides, or other substances. When the screen shown on the right is displayed, the combustible gas conversion function can be used only for the gas types marked with "O" in the "Conversion when conversion is restricted" column in the "Conversion gas list" section of "6-2-2. Combustible gas conversion setting." If you wish to continue to use the combustible gas conversion function for gas types marked with "x", please contact RIKEN KEIKI.

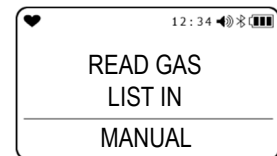

7-3-2. Switching from bump test (BUMP TEST) to measurement start screen

This section explains how to switch from bump test screen to measurement start screen.

- 1 Press the **AIR** button and select **"BUMP"**, then press the **MODE** button.

The bump test screen is displayed.



- 2 Press the **AIR** button and press **"START"** button.

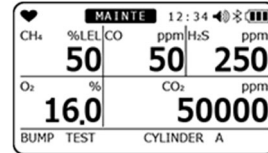

- 3 Press the **MODE** button.

The LCD lights up completely and will move to the measurement start screen.



7-4. Cleaning instructions

Clean the product if it becomes excessively dirty. Be sure to turn off the power before cleaning, and wipe clean using a rag or cloth soaked in water and firmly wrung out. Do not clean using water, organic solvents or commercially available cleaners for cleaning, as these may cause the product to malfunction.



CAUTION

- When wiping the product clean, do not splash water on it or use organic solvents like alcohol and benzene or commercially available cleaners. These may discolor or damage the surface of the product, or cause the sensors to malfunction.

NOTE

- Water may remain in the buzzer sound opening or grooves after the product has got wet. Remove any moisture as follows:
 - ① Wipe away moisture on the product thoroughly using a dry towel or cloth.
 - ② Hold the product firmly and shake it about ten times with the buzzer sound opening facing downward.
 - ③ Wipe away moisture escaping from the inside thoroughly using a towel or cloth.
 - ④ Place the product on a dry towel or cloth and allow it to stand at room temperature.

7-5. Parts replacement

7-5-1. Periodic replacement parts

The consumable parts of the product are listed below. Consumable parts should be replaced using the recommended replacement intervals as a guide.

<Recommended replacement parts list>

Name	Recommended check interval	Recommended replacement interval	Quantity (items per unit)	Remarks
Combustible gas sensor (NCR-6309)	6 months	3 years	1	*
O ₂ sensor (ESR-X13P)	6 months	3 years	1	*
CO/H ₂ S sensor (ESR-A1DP)	6 months	3 years	1	*
CO sensor (ESR-A13P)	6 months	3 years	1	*
CO sensor (ESR-A1CP)	6 months	3 years	1	*
H ₂ S sensor (ESR-A13i)	6 months	3 years	1	*
SO ₂ sensor (ESR-A13D)	6 months	3 years	1	*
NO ₂ sensor (ESR-A13D)	6 months	3 years	1	*
HCN sensor (ESR-A13D)	6 months	3 years	1	*
PH ₃ sensor (ESR-A13D2)	6 months	3 years	1	*
NH ₃ sensor (ESR-B134)	6 months	1 year	1	*
CO ₂ sensor (IRR-0409)	6 months	5 years	1	*
CO ₂ sensor (IRR-0433)	6 months	5 years	1	*
Dust filter	Before and after use	6 months or when contaminated	1	Part No.: 4777 9344 90 10-sheet set
Interference gas removal filter	3 months	6 months	1	For combustible gas sensor (NCR-6309) Part No.: 4777 9315 90 5-sheet set
Interference gas removal filter	3 months	6 months	1	For CO/H ₂ S sensor (ESR-A1DP) Part No.: 4777 9314 10 5-sheet set
Interference gas removal filter	3 months	6 months	1	For CO sensor (ESR-A1CP, ESR-A13P) Part No.: 4777 9316 60 5-sheet set
Interference gas removal filter	3 months	6 months	1	For H ₂ S and PH ₃ sensor (ESR-A13i, ESR-A13D2) Part No.: 4777 9317 30 5-sheet set
Interference gas removal filter	3 months	6 months	1	For NO ₂ sensor (ESR-A13D) Part No.: 4777 9318 10 5-sheet unit
Interference gas removal filter	3 months	6 months	1	For SO ₂ (ESR-A13D) Part No.: 4777 9569 10 5-sheet unit
Interference gas removal filter	3 months	6 months	1	For HCN sensor (ESR-A13D) Part No.: 4777 9372 10 5-sheet unit

Interference gas removal filter	3 months	6 months	1	For NH ₃ sensor (ESR-B134) Part No.: 4777 9417 70 5-sheet unit
Rubber seals	-	3 to 6 years	1 set	*
BUL-3R	-	Approx. 500 charging/discharging cycles	1	When using rechargeable battery unit (BUL-3R) Part No.: 4777 16*

*A functional check by a qualified service engineer is required after replacement. To ensure safety and the stable operation of the product, request checking by a qualified service engineer. Contact RIKEN KEIKI to request checking.

NOTE

- The above replacement intervals are guidelines only. Replacement intervals may vary depending on actual operating conditions. These intervals do not constitute warranty periods. Replacement intervals may vary depending on the results of regular maintenance.

7-5-2. Filter replacement

The dust filter and interference gas removal filters are consumables. Check the extent of contamination and replace them regularly.

<Dust filter replacement procedure>

- 1 Loosen the two screws on the underside of the main unit and release the two tabs.**
- 2 Detach the sensor cap and replace the dust filter with a new one.**
- 3 Reattach the sensor cap and press it until the two tabs click into place.**
- 4 Tighten the screws to secure the filter cap.**

The screws should be tightened with a torque of 15 to 16 N·cm.

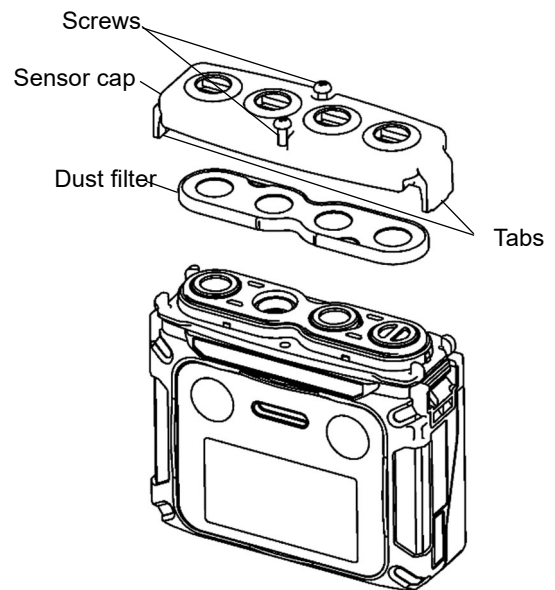

WARNING

- Install the dust filter correctly. Product performance cannot be guaranteed if it is misaligned.
- Replace the filter every six months. Replace the filter whenever it becomes contaminated even if it is less than six months.
- When replacing the dust filter or sensor filters, follow the procedure described in “Filter replacement”, tighten the screws securely, and make sure that the two tabs on the sensor cap are securely engaged. If the screws are loose or the tabs of the sensor cap are not securely engaged, foreign matter may get inside the product. Foreign matter may also get in if even minute particles are caught between the contact surfaces.
- Do not damage the rubber seal.
- To maintain performance, we recommend replacing all of the rubber seals every three to six years, regardless of condition.
- Be sure to use only dust filters and interference gas removal filters specifically intended for use with the product. Use of non-approved parts may adversely affect gas detection performance and allow water to get inside the product.

<Interference gas removal filter replacement>

- 1 Loosen the two screws on the underside of the main unit and release the two tabs.**
- 2 Remove the sensor cap, dust filter and individual sensor filters in sequence, and replace the individual sensor filters.**
- 3 Reseat the dust filter in its original position.**
- 4 Reattach the sensor cap and press it until the two tabs click into place.**
- 5 Tighten the screws to secure the filter cap.**
The screws should be tightened with a torque of 15 to 16 N·cm.

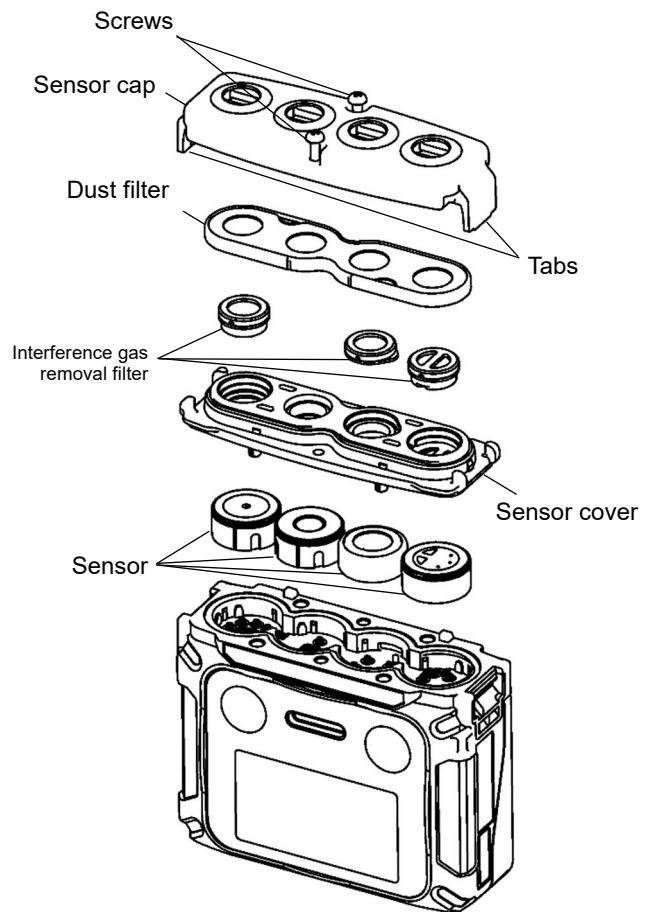

WARNING

- Install the individual interference gas removal filters correctly. If they are misaligned, gas may leak, preventing correct detection.
- Install the dust filter correctly. Product performance cannot be guaranteed if it is misaligned.
- Replace the filter every six months. Replace the filter whenever it becomes contaminated even if it is less than six months.
- When replacing the dust filter or individual interference gas removal filters, follow the procedure described in "Filter replacement", tighten the screws securely, and make sure that the two tabs on the sensor cap are securely engaged. If the screws are loose or the tabs of the sensor cap are not securely engaged, foreign matter may get inside the product. Foreign matter may also get in if even minute particles are caught between the contact surfaces.
- Do not damage the rubber seal.
- To maintain performance, we recommend replacing all of the rubber seals every three to six years, regardless of condition.
- Be sure to use only dust filters and interference gas removal filters specifically intended for use with the product. Use of non-approved parts may adversely affect gas detection performance and allow water to get inside the product.
- Use only the dedicated interference gas removal filter for each sensor. Otherwise gas may not be detected correctly.

8

Storage and Disposal

8-1. Procedures for storage or when not in use for extended periods

The product must be stored in the following environment:

- In a dark location at normal temperature and humidity away from direct sunlight
- In a location free of gases, solvents, and vapors

Store the product in its shipping carton if this has been retained.

If the shipping carton is not available, store away from dust and dirt.



CAUTION

- The product must always be stored with the lithium ion battery unit attached. The product constantly draws power for the sensors and clock even when the power is turned off. The sensors may be damaged or the clock may become offset if there is no power supply.
- When an ammonia (NH₃) sensor is installed, the indication may rise temporarily immediately after the sensor is energized due to its characteristics. When replacing the battery before it runs out, please wait at least 10 minutes before turning the power back on. Also. When the sensor is replaced, the battery is replaced because it is dead, or the battery is removed and has not been used for a long period of time, turn the power back on after 120 minutes or more.

NOTE

- If the product is not used for extended periods (three months or more), it should be stored with the lithium ion battery fully charged. Charge the battery every six months until it is fully charged.
 - If the lithium ion battery is stored on its own, we recommend storing after it is discharged until the battery level icon shows one bar.
 - The date and time setting may be reset if the product is stored for extended periods with the battery level icon showing one bar.
-

8-2. Procedures for use after storage

Perform calibration if the product is used again after a period in storage.



CAUTION

- Contact RIKEN KEIKI to request readjustment and calibration.
- If there is a temperature difference of 15 °C or more between the storage and usage locations, turn on the power and allow the product to stand for about 10 minutes in a similar environment to the usage location to acclimatize before performing air calibration in fresh air.

8-3. Product disposal

Dispose of the product as industrial waste (incombustible) in accordance with local regulations.



WARNING

- Never attempt to disassemble electrochemical type sensors, as they contain electrolyte. Electrolyte may cause inflammation if it comes into contact with the skin and may cause blindness if it comes into contact with the eyes. Electrolyte may discolor or decompose clothing if it comes into contact with clothing.
If contact occurs, rinse the area immediately with plenty of water.
- Dispose of dry batteries in accordance with procedure specified by the local authority.
- If the temperature between the storage and use locations changes rapidly by 15°C or more, acclimate the sensor in the same environment as the use location for about 10 minutes (about 30 minutes for ammonia (NH₃) sensors) with the power turned on, and perform air calibration in fresh air before use.

<Disposal in EU member states>

- Waste Electrical and Electronic Equipment (WEEE) directive



The symbol on the product shown on the left indicates that the product and its individual parts must not be disposed of with general or household waste, and must be sorted and disposed of appropriately.

Proper disposal will help prevent potential negative effects on human health and the environment.

To ensure proper treatment, collection, and recycling of the product at the time of its disposal, please use the return and collection system available in your country. For more information on collecting and recycling used products, please contact the dealer or supplier from whom you purchased the product.

- Battery regulations



The symbol on the product or battery shown on the left indicates that batteries must be disposed of separately from general or household waste.

To ensure proper treatment, collection, and recycling of batteries at the time of their disposal, please dispose of them properly using the collection system available in your country.

9

Troubleshooting

This troubleshooting chapter does not cover the causes of all possible product malfunctions. It provides brief explanations to assist in determining the causes of common problems.

If you encounter symptoms not addressed here or if problems persist even after taking corrective action, contact RIKEN KEIKI.

9-1. Product abnormalities

Symptoms <Screen display>	Cause	Action
The power cannot be turned on.	The battery is depleted.	Charge the battery in a safe place at ambient temperatures between 0 °C and +40 °C. Or replace it with a new battery.
	The POWER button was pressed for too short or too long a time.	To turn on the power, hold down the POWER button until the buzzer blips, and then release the button.
Abnormal operation	Disturbances due to sudden static electricity noise, etc.	Turn off the power once, and then turn it back on again.
Low battery voltage alarm indication <FAIL BATTERY>	Battery levels are low.	Turn off the power, and charge the battery in a safe place at ambient temperatures between 0 °C and +40 °C.
The power turns off immediately when it is turned on. <TURN OFF>	Battery levels are low.	Turn off the power, and charge the battery in a safe place at ambient temperatures between 0 °C and +40 °C.
Air calibration is not possible. <FAIL SENSOR>	The product is not surrounded by fresh air.	Provide fresh air.
	The sensor sensitivity has degraded.	Contact RIKEN KEIKI to request sensor replacement.
Bump testing is not possible.	The bump test gas concentration setting differs from the concentration of the bump test gas supplied.	Check to confirm that the bump test gas concentration setting matches the concentration of the bump test gas supplied.
	The sensor sensitivity has degraded.	Contact RIKEN KEIKI to request sensor replacement.

Span adjustment is not possible. <FAIL SENSOR>	The calibration gas concentration setting differs from the concentration of the calibration gas supplied.	Check to confirm that the calibration gas concentration setting matches the concentration of the gas supplied.
	Indication value decrease due to a dry environment. (only for ESR-A1CP H2)	Allow the unit to stand overnight or more in an environment with sufficient humidity and then perform gas calibration again.
	The sensor sensitivity has degraded.	Contact RIKEN KEIKI to request sensor replacement.

Symptoms <Screen display>	Cause	Action
A sensor abnormality is indicated in measurement mode. <FAIL SENSOR>	The sensor sensitivity has degraded.	Contact RIKEN KEIKI to request sensor replacement. (If "FAIL" appears in place of a measured value when the power is turned on, press the MODE button to reset the alarm. The gas sensors other than the faulty sensor can still be used.)
System abnormality <FAIL SYSTEM>	A circuit abnormality occurred in the main unit.	Contact RIKEN KEIKI for repair.
Error No. 000	Internal ROM abnormality	
Error No. 010	Internal RAM abnormality	
Error No. 021	Internal FRAM abnormality	
Error No. 031	FLASH abnormality	
Error No. 080	Acceleration sensor abnormality	
Error No. 081	PCB abnormality	
Error No. 082	Temperature sensor abnormality	
Error No. 083	Bluetooth fault	
Clock abnormality <FAIL CLOCK>	Internal clock abnormality	Set the date and time. (P. 77) If this symptom occurs frequently, the internal clock may be faulty and must be replaced. Contact RIKEN KEIKI.
Cannot access user mode.	Forgot user mode password.	Contact RIKEN KEIKI.
The charge LED flashes alternately green and orange.	The temperature is outside the allowable charging temperature range.	Charge at ambient temperatures between 0 °C and +40 °C.

9-2. Reading abnormalities

Symptoms <Screen display>	Cause	Action
The reading rises (or drops) and remains unchanged.	Sensor drift	Perform air calibration.
	Presence of interference gases	It is difficult to completely eliminate the effects of interference gases. Contact RIKEN KEIKI for information on countermeasures, such as interference gas removal filters.
	Slow leakage	There may be a very small leakage (slow leakage) of the detection target gas. Leaving this unresolved may lead to dangerous situations. Take the same action as for gas alarms.
	Environmental fluctuations	Perform air calibration.
A gas alarm is triggered even though there is no problem in the measuring environment.	Presence of interference gases	It is difficult to completely eliminate the effects of interference gases. Contact RIKEN KEIKI for information on countermeasures, such as interference gas removal filters.
	Effects of noise	Turn off the power once, and then turn it back on again (restart). If similar symptoms recur frequently, take appropriate measures to address the noise source.
Slow response	Dust filter clogging	Replace the dust filter.
	The sensor sensitivity has degraded.	Contact RIKEN KEIKI to request sensor replacement.

10

Product Specifications

10-1. Specifications list

<Common specifications>

Concentration display	LCD digital (full dot)
Detection method	Diffusion type
Displays	Clock, battery level, operation status
Display languages	Japanese/English/French/Spanish/Portuguese/German/Italian/Russian/ Vietnamese/Polish/Turkish/Romanian/Czech
Buzzer volume	Approx. 95 dB (mean value at 30 cm)
Gas alarm indication	Gas alarm: Lamp flashing, continuous modulating buzzer sounding, gas concentration display blinking, vibration
Gas alarm pattern	Self-latching
Fault alarm/self diagnosis	System abnormality, sensor abnormality, battery voltage drop, calibration failure
Fault alarm indication	Lamp flashing, intermittent buzzer sounding, detail display
Fault alarm pattern	Self-latching
Panic alarm indication	Prealarm: Lamp flashing, intermittent buzzer sounding (prealarm) Main alarm: Lamp flashing, continuous modulating buzzer sounding
Panic alarm pattern	Self-latching
Man down alarm indication	Prealarm: Lamp flashing, intermittent buzzer sounding (prealarm) Main alarm: Lamp flashing, continuous modulating buzzer sounding
Man down alarm pattern	Self-latching
Transmission specifications	IrDA (for data logger), BLE
Power source	Dedicated lithium ion battery unit (BUL-3R)
Continuous operating time	BUL-3R: Approx. 25 hours (with long-life battery off, no CO ₂ sensor, 25 °C, no alarm, no lighting) Approx. 16 hours (with long-life battery off, with CO ₂ sensor, 25 °C, no alarm, no lighting)
Operating pressure range	80 kPa to 120 kPa (80 kPa to 110 kPa for explosion-proof range)
Construction	Dust-proof, splash-proof construction equivalent to IP68, drop resistant to 7 m
Explosion-proof construction:	ATEX/IECEX specification: Intrinsically safe explosion-proof construction and flame-proof enclosures
Explosion-proof class	ATEX II 1 G Ex da ia IIC T4 Ga / I M1 Ex da ia I Ma (With combustible gas sensor) II 1 G Ex ia IIC T4 Ga / I M1 Ex ia I Ma (No combustible gas sensor) IECEX Ex da ia IIC T4 Ga / Ex da ia I Ma (With combustible gas sensor) Ex ia IIC T4 Ga / Ex ia I Ma (No combustible gas sensor)

External dimensions	With BUL-3R: Approx. 73 mm (W) × 65 mm (H) × 26 mm (D) (excluding projections)
Weight	With BUL-3R: Approx. 120 g

<Individual sensor specifications>

Item	Detection target gas	Combustible gas	
		Isobutane (i-C ₄ H ₁₀)*	Methan (CH ₄)*
Sensor model		NCR-6309	
Detection range		0 %LEL to 100 %LEL (1.3 vol%)	0 %LEL to 100 %LEL (4.4 vol%)
1 digit		1 %LEL	
Alarm setpoints (ATEX/IECEX specification)		1st alarm: 10 %LEL 2nd alarm: 25 %LEL 3rd alarm: 50 %LEL OVER alarm: 100 %LEL	
Detection principle		New ceramic type	
Operating temperature range		Temporary use environment: -40 °C to +60 °C (no sudden changes) Continuous use environment: -20 °C to +50 °C (no sudden changes)	
Operating humidity range		Temporary use environment: 0 %RH to 95 %RH (no condensation) Continuous use environment: 10 %RH to 90 %RH (no condensation)	

* The factory default setting is either CH₄ or HC (specified in the order).

Item	Detection target gas	Oxygen (O ₂)	Carbon monoxide (CO)	Hydrogen sulfide (H ₂ S)
Sensor model		ESR-X13P	ESR-A1DP	
Measurement range (ATEX/IECEX specification)		0 to 25.0 %	0 to 500 ppm	0 to 100.0 ppm
Service range (ATEX/IECEX specification)		25.1 to 40.0 %	501 to 2,000 ppm	100.1 to 200.0 ppm
1 digit		0.1 %	1 ppm	0.1 ppm
Alarm setpoints (ATEX/IECEX specification)		L alarm: 19.5 % LL alarm: 18.0 % H alarm: 23.5 % OVER alarm: 40.0 %	1st alarm: 25 ppm 2nd alarm: 50 ppm 3rd alarm: 1,200 ppm TWA alarm: 25 ppm STEL alarm: 200 ppm OVER alarm: 2,000 ppm	1st alarm: 5.0 ppm 2nd alarm: 30.0 ppm 3rd alarm: 100.0 ppm TWA alarm: 1.0 ppm STEL alarm: 5.0 ppm OVER alarm: 200.0 ppm
Detection principle		Electrochemical type		
Operating temperature range		Temporary use environment: -40 °C to +60 °C (no sudden changes) Continuous use environment: -20 °C to +50 °C (no sudden changes)		
Operating humidity range		Temporary use environment: 0 %RH to 95 %RH (no condensation) Continuous use environment: 10 %RH to 90 %RH (no condensation)		

Item	Detection target gas	Oxygen (O ₂)	Carbon monoxide (CO)*	Hydrogen sulfide (H ₂ S)
Sensor model		ESR-A13P	ESR-A1CP	ESR-A13i
Measurement range (ATEX/IECEX specification)		0 to 25.0 %	0 to 500 ppm	0 to 100.0 ppm
Service range (ATEX/IECEX specification)		25.1 to 40.0 %	501 to 2,000 ppm	100.1 to 200.0 ppm
1 digit		0.1 %	1 ppm	0.1 ppm
Alarm setpoints (ATEX/IECEX specification)		L alarm: 19.5 % LL alarm: 18.0 % H alarm: 23.5 % OVER alarm: 40.0 %	1st alarm: 25 ppm 2nd alarm: 50 ppm 3rd alarm: 1,200 ppm TWA alarm: 25 ppm STEL alarm: 200 ppm OVER alarm: 2,000 ppm	1st alarm: 5.0 ppm 2nd alarm: 30.0 ppm 3rd alarm: 100.0 ppm TWA alarm: 1.0 ppm STEL alarm: 5.0 ppm OVER alarm: 200.0 ppm
Detection principle	Electrochemical type			
Operating temperature range	Temporary use environment: -40 °C to +60 °C (no sudden changes) Continuous use environment: -20 °C to +50 °C (no sudden changes)			
Operating humidity range	Temporary use environment: 0 %RH to 95 %RH (no condensation) Continuous use environment: 10 %RH to 90 %RH (no condensation)			

*The carbon monoxide sensor (ESR-A1CP) includes a correction function to reduce interference due to hydrogen. This function works for hydrogen concentrations up to 2,000 ppm. (However, if used in an environment exceeding 40°C for more than 15 minutes, it may be affected by hydrogen interference and may indicate a higher carbon monoxide concentration than actual.)

Item	Detection target gas	Carbon dioxide (CO ₂)	
Sensor model		IRR-0409	IRR-0433
Measurement range		0 to 5.00 vol%	0 to 10,000 ppm
Service range		5.01 to 10.00 vol%	-
1 digit		0.01 vol%	20 ppm
Alarm setpoints		1st alarm: 0.50 vol% 2nd alarm: 3.00 vol% 3rd alarm: 3.00 vol% TWA alarm: 0.50 vol% STEL alarm: 3.00 vol% OVER alarm: 10.00 vol%	1st alarm: 5,000 ppm 2nd alarm: 5,000 ppm 3rd alarm: 5,000 ppm TWA alarm: 5,000 ppm OVER alarm: 10,000 ppm
Detection principle	Non-dispersive infrared absorption method (NDIR)		
Operating temperature range	Temporary use environment: -40 °C to +60 °C (no sudden changes) Continuous use environment: -20 °C to +50 °C (no sudden changes)		
Operating humidity range	Temporary use environment: 0 %RH to 95 %RH (no condensation) Continuous use environment: 10 %RH to 90 %RH (no condensation)		

Item	Detection target gas	Sulfur dioxide (SO ₂)	Nitrogen dioxide (NO ₂)
Sensor model		ESR-A13D	ESR-A13D
Measurement range		0 to 20.00 ppm	0 to 20.00 ppm
Service range		20.05 to 100.00 ppm	-
1 digit		0.05 ppm	0.05 ppm
Alarm setpoints (ATEX/IECEX specification)		1st alarm: 2.00 ppm 2nd alarm: 5.00 ppm 3rd alarm: 100.00 ppm TWA alarm: 2.00 ppm STEL alarm: 5.00 ppm OVER alarm: 100.00 ppm	1st alarm: 2.00 ppm 2nd alarm: 4.00 ppm 3rd alarm: 20.00 ppm TWA alarm: 0.50 ppm STEL alarm: 1.00 ppm OVER alarm: 20.00 ppm
Detection principle		Electrochemical type	
Operating temperature range		Temporary use environment: -40 °C to +60 °C (no sudden changes) Continuous use environment: -20 °C to +50 °C (no sudden changes)	
Operating humidity range		Temporary use environment: 0 %RH to 95 %RH (no condensation) Continuous use environment: 10 %RH to 90 %RH (no condensation)	

Item	Detection target gas	Hydrogen cyanide (HCN)	Phosphine (PH ₃)
Sensor model		ESR-A13D	ESR-A13D2
Measurement range		0 to 30.0 ppm*	0 to 20.00 ppm
Service range		-	-
1 digit		0.1 ppm	0.01 ppm
Alarm setpoints (ATEX/IECEX specification)		1st alarm: 10.0 ppm 2nd alarm: 20.0 ppm 3rd alarm: 30.0 ppm TWA alarm: 0.9 ppm STEL alarm: 4.5 ppm OVER alarm: 30.0 ppm	1st alarm: 0.30 ppm 2nd alarm: 0.60 ppm 3rd alarm: 1.00 ppm TWA alarm: 0.30 ppm STEL alarm: 1.00 ppm OVER alarm: 20.00 ppm
Detection principle		Electrochemical type	
Operating temperature range		Temporary use environment: -20 °C to +60 °C (no sudden changes) Continuous use environment: -20 °C to +50 °C (no sudden changes)	Temporary use environment: -40 °C to +60 °C (no sudden changes) Continuous use environment: -20 °C to +50 °C (no sudden changes)
Operating humidity range		Temporary use environment: 0 %RH to 95 %RH (no condensation) Continuous use environment: 10 %RH to 90 %RH (no condensation)	

* The HCN sensor displays 0.0 to 0.2 ppm as 0.0 ppm.

Item	Detection target gas	Ammonia (NH ₃)
Sensor model		ESR-B134
Display range		0 to 400.0 ppm
Detection range		0 to 300.0 ppm
Resolution		0.5 ppm
Alarm setpoints (ATEX/IECEX specification)		1st alarm: 25.0 ppm 2nd alarm: 35.0 ppm 3rd alarm: 35.0 ppm TWA alarm: 25.0 ppm STEL alarm: 35.0 ppm OVER alarm: 400.0 ppm
Detection principle		Electrochemical type
Operating temperature range		Temporary use environment: -30 °C to +50 °C (no sudden changes) Continuous use environment: -20 °C to +50 °C (no sudden changes)
Operating humidity range		Temporary use environment: 0 %RH to 95 %RH (no condensation) Continuous use environment: 10 %RH to 90 %RH (no condensation)

10-2. Accessory list

Standard accessories (ATEX/IECEx specification)

Part name	Part number
Hand strap	0888 0605 90
Rubber protection cover	4777 4175 00
Ultra-slim alligator clip (with attachment screw)	4777 9203 10
AC adapter (In case of BUL-3R)	2594 0898 30
EU-PLUG (In case of BUL-3R)	2594 0933 60
Calibration adapter (simple type)	4777 9370 70

<Optional items (sold separately)>

Part name	Part No.
Belt clip (with attachment screw)	4777 9202 40
Ultra-slim alligator clip (with attachment screw)	4777 9203 10
Belt assembly (with attachment fixture and screw)	4777 9293 30
Filter unit set (for ESR-A1DP) 5-sheet set	4777 9314 10
Filter unit set (for NCR-6309) 5-sheet set	4777 9315 90
Filter unit set (for ESR-A1CP, ESR-A13P) 5-sheet set	4777 9316 60
Filter unit set (for ESR-A13i, ESR-A13D2) 5-sheet set	4777 9317 30
Filter unit set (for ESR-A13D, NO ₂ sensor) 5-sheet set	4777 9318 10
Filter unit set (for ESR-A13D, SO ₂ sensor) 5-sheet set	4777 9569 10
Filter unit set (for ESR-B134) 5-sheet set	4777 9417 70
Dust filter 10-sheet set	4777 9344 90
Protective film 5-sheet set	4777 9296 50
Leather case	4777 4258 70
Heat-resistant case (not explosion-proof)	4777 4260 80
Manual suction kit (with sampling rod)	4777 9297 20
Manual suction kit (with 8m float-type tube)	4777 9299 70
Manual suction kit (with weighted 30 m tube)	4777 9300 30
BUL-3R + accessories	4777 9277 40
BUL-3R + accessories	4777 9281 00
AC adapter	2594 0898 30
AU plug	2594 0932 90
EU plug	2594 0933 60
UK plug	2594 0934 30
Calibration adapter (simple type)	4777 9370 70
Calibration adapter	4777 9312 70
Charging cradle (BC-3R)	BC-3R 00
Charging cradle wall-mounting fixture	4777 4337 50
5-unit charging cable w/o AC adapter (cable length: 22.5cm)	4777 9329 70
5-unit charging cable w/o AC adapter (cable length: 60cm)	4777 9319 80
5-unit charging cable w/o AC adapter (cable length: 120cm)	4777 9333 20
Data logger management program (SW-GX-3R(EX))	9811 0870 60

11

Appendix

Data logger function

The product is equipped with a data logger function that records measurement results and events such as gas alarms, fault alarms, and calibration.

NOTE

- The data logger management program (sold separately) is required to check data recorded using the data logger function. Contact RIKEN KEIKI for more information.

The data logger provides the following five functions:

(1) Interval trend

Records the changes in measured concentration from when the power is turned on until it is turned off. For combustible gases, carbon monoxide, and hydrogen sulfide, the average value, peak value, and peak value detection time are recorded; for oxygen, the average value, minimum value, minimum value detection time, peak value, and peak value detection time are recorded.

Records data for the 3,600 most recent items.

If the number of items exceeds 3,600, the oldest data will be overwritten by the latest data.

If overwriting is disabled, recording stops when 3,600 is exceeded.

If 3,600 items are recorded for a single measurement, the oldest data will not be overwritten, and recording will stop even if overwriting is enabled.

* However, if the maximum recording time is exceeded, the oldest data will be deleted even before reaching 3,600.

The maximum recording times corresponding to different intervals are as follows:

Interval	10 seconds	20 seconds	30 seconds	1 minute	3 minutes	5 minutes	10 minutes
Maximum recording time	10 hours	20 hours	30 hours	60 hours	180 hours	300 hours	600 hours

* The standard interval is 5 minutes.

The interval can be set using the Data Logger Management Program (sold separately).

(2) Alarm trend

When an alarm is triggered, this function records the changes in measured concentration for 30 minutes before and after the alarm occurred (one hour in total).

Alarm trend records peak values (minimum values for oxygen) over 5-second periods at 5-second intervals.

Records data for the eight most recent items.

If the number of items exceeds eight, the oldest data will be overwritten by the latest data.

(3) Alarm event

Records alarm occurrences as events.

This function records the time the alarm was triggered, the measurement target gas, and the type of alarm event.

Records the 100 most recent events.

If the number of events exceeds 100, the oldest data will be overwritten by the latest data.

(4) Trouble event

Records fault alarm occurrences as events.

This function records the time when the fault alarm was triggered, the measurement target gas, device information, and the type of trouble event.

Records the 100 most recent events.

If the number of events exceeds 100, the oldest data will be overwritten by the latest data.

(5) Calibration history

Records data when calibration is performed.

This function records calibration time, concentration values before and after calibration, and calibration errors.

Records data for the 100 most recent calibrations.

If the number of calibrations exceeds 100, the oldest data will be overwritten by the latest data.

NOTE

- Communication mode starts automatically if the infrared communication port of the product is positioned where IrDA communication is available while the date and time or battery level/gas alarm pattern are displayed after the power is turned on. You can also enter communication mode by pressing the **AIR** and **POWER** buttons at the same time with the infrared communication port of the product positioned where IrDA communication is available.
 - A fault alarm will be triggered if no communication connection can be confirmed for a preset duration in communication mode. If this occurs, either repeat the communication connection or turn off the power for the product.
-

100 %LEL = ppm conversion list

The following table shows the standard conversion for 100 %LEL and ppm.

		Standard	IEC (Default setting)	ISO
Methane	CH₄	50,000 ppm	44,000 ppm	44,000 ppm
Isobutane	i-C₄H₁₀	18,000 ppm	13,000 ppm	15,000 ppm
Hydrogen	H₂	40,000 ppm	40,000 ppm	40,000 ppm
Methanol	CH₃OH	55,000 ppm	60,000 ppm	60,000 ppm
Acetylene	C₂H₂	15,000 ppm	23,000 ppm	23,000 ppm
Ethylene	C₂H₄	27,000 ppm	23,000 ppm	24,000 ppm
Ethane	C₂H₆	30,000 ppm	24,000 ppm	24,000 ppm
Ethanol	C₂H₅OH	33,000 ppm	31,000 ppm	31,000 ppm
Propylene	C₃H₆	20,000 ppm	20,000 ppm	18,000 ppm
Acetone	C₃H₆O	21,500 ppm	25,000 ppm	25,000 ppm
Propane	C₃H₈	20,000 ppm	17,000 ppm	17,000 ppm
Butadiene	C₄H₆	11,000 ppm	14,000 ppm	14,000 ppm
Cyclopentane	C₅H₁₀	14,000 ppm	14,000 ppm	14,000 ppm
Benzene	C₆H₆	12,000 ppm	12,000 ppm	12,000 ppm
N-hexane	n-C₆H₁₄	12,000 ppm	10,000 ppm	10,000 ppm
Toluene	C₇H₈	12,000 ppm	10,000 ppm	10,000 ppm
N-heptane	n-C₇H₁₆	11,000 ppm	8,500 ppm	8,000 ppm
Xylene	C₈H₁₀	10,000 ppm	10,000 ppm	10,000 ppm
N-nonane	n-C₉H₂₀	7,000 ppm	7,000 ppm	7,000 ppm
Ethyl acetate	EtAc	21,000 ppm	20,000 ppm	20,000 ppm
Isopropyl alcohol	IPA	20,000 ppm	20,000 ppm	20,000 ppm
Methyl ethyl ketone	MEK	18,000 ppm	15,000 ppm	15,000 ppm
Methyl methacrylate	MMA	17,000 ppm	17,000 ppm	17,000 ppm
Dimethyl ether	DME	30,000 ppm	27,000 ppm	27,000 ppm
Methyl isobutyl ketone	MIBK	12,000 ppm	12,000 ppm	12,000 ppm
Tetrahydrofuran	THF	20,000 ppm	15,000 ppm	15,000 ppm

* "IEC" is based on EN 60079-20-1: 2010 and "ISO" is based on ISO 10156: 2017.

Radio Law Certification

This product is certified as complying with radio laws in individual countries and regions as follows. Information related to radio law certification can be checked on the product LCD screen.

The following actions are prohibited by radio laws. The user and/or retailer may be subject to punishment if prohibited actions are committed.

- Use in countries or regions in which radio law certification has not been obtained
- Sale in countries or regions in which radio law certification has not been obtained
- Disassembly or modification of the product
- Removal of certification labels from the product



If this product is used aboard marine vessels, the radio laws of the country bordering the territorial waters shall apply. In such cases, use shall be prohibited in countries or regions in which radio law certification has not been obtained.

Check to confirm that industrial, scientific, and medical equipment (e.g., microwave ovens), on-premises radio stations for mobile identification used in plant manufacturing lines (radio stations requiring a license), and specified low-power radio stations are not operated in the frequency band (2.4 GHz) used by this product. If the product causes radio interference to a radio station for mobile identification, take measures to eliminate radio interference—for example, using the product in a different location or stopping radio emissions.



The countries where wireless communication can be used vary with each specification. Please check the nameplate attached to the product.



Wireless specifications

Wireless communication	Protocol: Bluetooth Low Energy Version: Ver. 4.2 Frequency: 2,402 to 2,480 MHz Modulation: FSK Output: Maximum 6 dBm
------------------------	--

Radio law certification (Country/region)	Details
Radio Act (Japan)	<p>This product contains radio equipment certified to comply with technical standards in accordance with the Radio Act. Accordingly, a radio station license is not required when using this product.</p>  <p>Construction design certification number: 005-103120 Wireless frequency: 2,402 MHz to 2,480 MHz Maximum wireless output: 6 dBm</p>
RE Directive (EU Countries)	 <p>We declare that this equipment complies with the basic requirements of Directive 2014/53/EU and other relevant provisions. Connect to the network with radio waves of frequency 2.4 GHz band and maximum output 6dBm.</p>
FCC compliance (United States)	<p>This device complies with part 15 of the FCC Rules. Operation is subject to the following two conditions: (1) This device may not cause harmful interference, and (2) this device must accept any interference received, including interference that may cause undesired operation.</p> <p>FCC CAUTION</p>

	<p>Changes or modifications not expressly approved by the party responsible for compliance could void the user's authority to operate the equipment.</p> <p>Note: This equipment has been tested and found to comply with the limits for a Class A digital device, pursuant to part 15 of the FCC Rules. These limits are designed to provide reasonable protection against harmful interference when the equipment is operated in a commercial environment. This equipment generates, uses, and can radiate radio frequency energy and, if not installed and used in accordance with the instruction manual, may cause harmful interference to radio communications. Operation of this equipment in a residential area is likely to cause harmful interference in which case the user will be required to correct the interference at his own expense.</p> <p>This equipment complies with FCC radiation exposure limits set forth for an uncontrolled environment and meets the FCC radio frequency (RF) Exposure Guidelines. This equipment has very low levels of RF energy that is deemed to comply without testing of specific absorption rate (SAR).</p>
<p>IC compliance (Canada)</p>	<p>This device complies with Industry Canada's licence-exempt RSSs. Operation is subject to the following two conditions: (1) This device may not cause interference; and (2) This device must accept any interference, including interference that may cause undesired operation of the device.</p> <p>Le présent appareil est conforme aux CNR d'Industrie Canada applicables aux appareils radio exempts de licence. L'exploitation est autorisée aux deux conditions suivantes : 1) l'appareil ne doit pas produire de brouillage; 2) l'utilisateur de l'appareil doit accepter tout brouillage radioélectrique subi, même si le brouillage est susceptible d'en compromettre le fonctionnement.</p> <p>This equipment complies with IC radiation exposure limits set forth for an uncontrolled environment and meets RSS-102 of the IC radio frequency (RF) Exposure rules. This equipment has very low levels of RF energy that is deemed to comply without testing of specific absorption rate (SAR).</p> <p>Cet équipement est conforme aux limites d'exposition aux rayonnements énoncées pour un environnement non contrôlé et respecte les règles d'exposition aux fréquences radioélectriques (RF) CNR-102 de l'IC. Cet équipement émet une énergie RF très faible qui est considérée comme conforme sans évaluation du débit d'absorption spécifique (DAS).</p>
<p>KCC (KOREA)</p>	 <p>Identification code: R-C-GD5-GX-3RPro_RIKEN Compliance approval applicant: RIKEN KEIKI Co., Ltd. Product name: Portable Gas Monitor Model: GX-3R Pro Manufacturer: RIKEN KEIKI Co., Ltd. Country of manufacture: Japan</p>

	<p>Class A device (broadcast communication device for business use) This product is a radio wave transmitting device for business use (Class A), and is intended for use in non-household locations. Retailers and users must pay attention to this point.</p> <p>A급 기기 (업무용 방송통신기자재) 이 기기는 업무용(A급) 전자파적합기기로서 판매자 또는 사용자는 이 점을 주의하시기 바라며, 가정외의 지역에서 사용하는 것을 목적으로 합니다.</p>
<p>IMDA (SINGAPORE)</p>	<p>Certification label:</p> <div data-bbox="459 577 753 748" style="border: 1px solid black; padding: 5px; text-align: center;"> <p>Complies with IMDA Standards DA107653</p> </div>
<p>ANATEL (BRASIL)</p>	<p>MODEL : GX-3R Pro Approval number: 00026-25-12084</p> <div data-bbox="464 882 794 1196" style="text-align: center;">  </div> <ul style="list-style-type: none"> • ANATEL Resolution 680 descriptive requirements This equipment is not entitled to protection against harmful interference and may not cause interference in duly authorized systems <p style="text-align: center;">Este equipamento não tem direito à proteção contra interferência prejudicial e não pode causar interferência em sistemas devidamente autorizados</p> <ul style="list-style-type: none"> • ANATEL Web "Para consultas, visite : www.anatel.gov.br"
<p>ACMA (AUSTRALIA)</p>	<p>MODEL : GX-3R Pro</p> <div data-bbox="475 1711 778 1935" style="text-align: center;">  </div>

Minsvyaz (Russia)	Радиоэлектронные средства технологии «Bluetooth» в полосе радиочастот 2400 - 2483,5 МГц с максимальной эквивалентной изотропно излучаемой мощностью передатчика не более 2,5 мВт.
SRRC (CHINA)	Approval certification number: Dry batteries: CMIIT ID:2020DP3197 Lithium batteries: CMIIT ID:2020DP1516 Model: GX-3RPRO Protocol: Bluetooth Low Energy Version: Ver. 4.2 Frequency: 2,402 to 2,480 MHz Modulation: FSK Output: Maximum 6 dBm
NBTC (THAI)	<p>This telecommunication equipment conforms to the standard or technical requirements of NBTC.</p> <div data-bbox="464 779 911 1223" style="border: 1px solid black; padding: 10px; text-align: center;">  <p>เครื่องวิทยุคมนาคมนี้ ได้รับยกเว้น ไม่ต้องได้รับใบอนุญาตให้มี ใช้ซึ่งเครื่องวิทยุคมนาคมหรือตั้งสถานีวิทยุคมนาคมตามประกาศ กสทช. เรื่อง เครื่องวิทยุคมนาคม และสถานีวิทยุคมนาคมที่ได้รับยกเว้นไม่ต้องได้รับใบอนุญาตวิทยุคมนาคม ตามพระราชบัญญัติวิทยุคมนาคม พ.ศ. 2498</p>  <p>nanb. โทรคมนาคม กำกับดูแลเพื่อประชาชน Call Center 1200 (Insw5)</p> </div>

Limited Warranty and Limitation Liability

RIKEN KEIKI CO.,LTD. (RIKEN) warrants the product to be free from defects in material and workmanship under normal use and service for a period of three years (one year for NH₃ sensors only), beginning on the date of shipment to the buyer. This warranty extends only to the sale of new and unused products to the original buyer. RIKEN's warranty obligation is limited, at RIKEN's option, to repair or replacement of a defective product that is returned to a RIKEN KEIKI Quality control center located in Japan within the warranty period. In no event shall RIKEN's liability hereunder exceed the purchase price actually paid by the buyer for the Product.

This warranty does not include:

- a) fuses, disposable batteries or the routine replacement of parts due to the normal wear and tear of the product arising from use;
- b) any product which in RIKEN's opinion, has been misused, altered, neglected or damaged, by accident or abnormal conditions of operation, handling or use;
- c) any damage or defects attributable to repair of the product by any person other than an authorized dealer, or the installation of unapproved parts on the product; or

The obligations set forth in this warranty are conditional on:

- a) proper storage, installation, calibration, use, maintenance and compliance with the product manual instructions and any other applicable recommendations of RIKEN;
- b) the buyer promptly notifying RIKEN of any defect and, if required, promptly making the product available for correction. No goods shall be returned to RIKEN until receipt by the buyer of shipping instructions from RIKEN; and
- c) the right of RIKEN to require that the buyer provide proof of purchase such as the original invoice, bill of sale or packing slip to establish that the product is within the warranty period.

THE BUYER AGREES THAT THIS WARRANTY IS THE BUYER'S SOLE AND EXCLUSIVE REMEDY AND IS IN LIEU OF ALL OTHER WARRANTIES, EXPRESS OR IMPLIED, INCLUDING BUT NOT LIMITED TO ANY IMPLIED WARRANTY OF MERCHANTABILITY OR FITNESS FOR A PARTICULAR PURPOSE. RIKEN SHALL NOT BE LIABLE FOR ANY SPECIAL, INDIRECT, INCIDENTAL, OR BASED ON CONTRACT, TORT OR RELIANCE OR ANY OTHER THEORY.

Since some countries or states do not allow limitation of the term of an implied warranty, or exclusion or limitation of incidental or consequential damages, the limitations and exclusions of this warranty may not apply to every buyer. If any provision of this warranty is held invalid or unenforceable by a court of competent jurisdiction, such holding will not affect the validity or enforceability of any other provision.

Contacting RIKEN KEIKI

Email us at: intdept@rikenkeiki.co.jp

Visit RIKEN KEIKI website at: <https://www.rikenkeiki.com/>

JAPAN: +81-3-3966-1113

Revision or Abolition History

Edition	Revision	Issue date
0	First issue	2021/4/6
1	Update Declaration of Conformity	2021/7/21
2	Update Declaration of Conformity	2021/10/29
3	Error correction	2021/12/7
4	4-1 note added, 6-2-2 reading list added, 6-4-4 bump expiration date selection changed, 6-4-6 alarm point setting lower limit changed, note added	2022/3/15
5	6-4-3 Calibration expiration date interval changed, 7-2-8 Calibration gas concentration setting range Updated	2022/6/3
6	7-2-8 corrections, notes about the combustible gas conversion function and long-life battery added, NH ₃ added, DoC updated	2022/8/1
7	Filter for SO ₂ sensor changed, Note for ESR-A1CP added, Man down alarm upper limit changed, Part number for Data Logger Management program corrected	2023/6/28
8	1-5 UKCA marking added, 2-4 applicable standards added, UKCA DoC added	2023/9/11
9	UKEX and UKCA deleted, DoC updated	2024/1/10
10	2-4 specific conditions of use added, DoC updated	2024/5/31
11	Changed the number for Brazilian Radio Law certification.	2025/2/21
12	DoC deleted, 8-3 Product disposal corrected	2025/8/29
13	2-4 Rechargeable battery added	2025/11/28
14	Changed the number for Japan Radio Law certification, deleted Taiwan Radio Law certification	2026/6/5