



PT0E-2042

**Portable Gas Monitor
GX-3R
(MED specification)
Operating Manual
(PT0-164)**

RIKEN KEIKI Co., Ltd.

2-7-6 Azusawa, Itabashi-ku, Tokyo, 174-8744, Japan

Phone : +81-3-3966-1113

Fax : +81-3-3558-9110

E-mail : intdept@rikenkeiki.co.jp

Web site : <https://www.rikenkeiki.co.jp/>

Contents

1	Product Overview	4
1-1.	Introduction	4
1-2.	Intended use	4
1-3.	DANGER, WARNING, CAUTION, and NOTE	6
1-4.	Checking standards and explosion-proof specifications	6
2	Important Safety Information	7
2-1.	Danger information	7
2-2.	Warning information	8
2-3.	Caution information	9
2-4.	Safety information	11
3	Product Configuration	14
3-1.	Main unit and standard accessories	14
	Main unit	14
	Standard accessories	15
3-2.	Part names and functions	16
	Main unit	16
	LCD display	17
4	Alarm Activation	18
4-1.	Gas alarm activation	18
4-2.	Fault alarm activation	20
5	Usage Instructions	21
5-1.	Before using the product	21
5-2.	Preparing startup	21
	5-2-1. Charging the lithium ion battery	21
5-3.	Startup	23
	Turning on the power	23
	Screen transition from powering on to displaying measurement screen	24
5-4.	Air calibration	27
	Air calibration procedure	27
5-5.	Gas detection	28
	5-5-1. Basic operating procedures	28
	5-5-2. Measurement mode	29
5-6.	Turning off the power	31
6	Setting Procedure	32
6-1.	Display mode	32
	6-1-1. Displaying display mode	32
	6-1-2. Display mode display details	32
6-2.	Display mode settings	34
	6-2-1. Clearing PEAK value display	34
	6-2-2. Combustible conversion gas selection	35
	6-2-3. Long-life battery setting	37
	6-2-4. Calibration data display	38
	6-2-5. Bump data display	39
	6-2-5. Alarm setpoint display	40
6-3.	User mode	41
	6-3-1. Displaying user mode	41
	6-3-2. User mode settings	42
6-4.	User mode settings	44
	6-4-1. Bump test	44
	6-4-2. Calibration	44
	6-4-3. Calibration expiration date setting	44
	6-4-4. Bump test setting	47
	6-4-5. Alarm setpoint setting	52

6-4-6. Lunch break: ON/OFF	54
6-4-7. Confirmation beep setting	55
6-4-8. LCD lighting time setting	57
6-4-9. Key tone: ON/OFF	57
6-4-10. Display mode item display: ON/OFF	58
6-4-11. Date and time setting	58
6-4-12. User password setting	59
6-4-13. ROM/SUM display	60
7 Maintenance	61
7-1. Maintenance intervals and maintenance items	61
Maintenance service	62
7-2. Calibration	63
7-2-1. Preparation for calibration	63
7-2-2. Calibration setting menu	65
7-2-3. Air calibration	66
7-2-4. Auto calibration	67
7-2-5. Switch from AUTO calibration to measurement start screen	69
7-2-6. Auto calibration cylinder setting	70
7-2-7. Auto calibration gas concentration selection	71
7-3. Bump test	72
7-3-1. Perform bump test (BUMP TEST)	72
7-3-2. Switching from bump test (BUMP TEST) to measurement start screen	73
7-4. Cleaning instructions	74
7-5. Parts replacement	75
7-5-1. Periodic replacement parts	75
7-5-2. Filter replacement	76
8 Storage and Disposal	79
8-1. Procedures for storage or when not in use for extended periods	79
8-2. Procedures for use after storage	79
8-3. Product disposal	80
9 Troubleshooting	81
9-1. Product abnormalities	81
9-2. Reading abnormalities	83
10 Product Specifications	84
10-1. Specifications list	84
10-2. Accessory list	87
11 Appendix	88
Data logger function	88
100 %LEL = ppm conversion list	90
Limited Warranty and Limitation Liability	91

1

Product Overview

1-1. Introduction

Thank you for your purchase of the GX-3R MED specification Portable Gas Monitor (“product” hereinafter). First, please confirm that the model number of the product you purchased matches the model number of the product covered by this manual.

The product should be used only by fully-trained personnel. Maintenance procedures described in this manual should be performed only by fully-trained personnel. Any maintenance procedure not described in this manual must be performed by Riken Keiki or our certified service engineers. Please contact Riken Keiki.

This manual describes how to use the product and provides product specifications. Make sure you have read and fully understood the contents of this manual before using the product. This applies both to first-time users and those who have previously used the product. Keep this manual in a safe place for future reference.

The contents of this manual are subject to change without notice to allow product improvements. Any duplication or reproduction of this manual without permission is prohibited, whether in whole or in part.

In addition to this manual, manuals are also provided for optional products (sold separately). Refer to the following manuals along with this manual when using optional products (sold separately):

- 1) RP-3R Pump unit Operating Manual (PT0E-166)
- 2) SW-GX-3R Data Logger Management Program Software Operating Manual (PT0E-178)
- 3) SDM-3R Docking Station Operating Manual (PT0E-167)

Regardless of the warranty period, Riken Keiki does not accept any liability for accidents or damage resulting from use of the product. Be sure to read the warranty policy set forth on the warranty.

1-2. Intended use

The product is a multi-gas monitor equipped with up to three types of sensors to enable detection of four different gas types using a single unit.

The product comes in several different types, depending on the combinations of detection target gases. Check the specifications before use to confirm the correct gases will be detected in accordance with the intended purpose.

The product is a gas detector designed to measure the concentrations of chemicals in the air in working environments. It measures concentrations of toxic gases, combustible gases, and oxygen in the air and issues an alarm if concentrations exceed preset levels, thereby alerting users to the hazards of gas poisoning and oxygen deficiency.



<List of detection target gases (installed sensor models) by type>

TYPE	Detection target gases (installed sensor models)					
	Combustible gas <HC or CH ₄ > (NCR-6309)	Oxygen (ESR-X13P)	Carbon monoxide/hydrogen sulfide (ESR-A1DP)	Hydrogen sulfide (ESR-A13i)	Carbon monoxide (ESR-A13P)	Carbon monoxide (ESR-A1CP)*
TYPE A	○	○	○			
TYPE B	○	○		○		
TYPE C	○	○			○	
TYPE CH	○	○				○
TYPE D	○	○				
TYPE E		○		○		
TYPE F		○			○	
TYPE FH		○				○
TYPE G	○					
TYPE I	○				○	
TYPE IH	○					○
TYPE K				○		
TYPE L	○			○		

* The carbon monoxide sensor (ESR-A1CP) includes a correction function to reduce interference due to hydrogen. This function works for hydrogen concentrations up to 2,000 ppm.

1-3. DANGER, WARNING, CAUTION, and NOTE

This manual uses the following headings to ensure safe and effective work:

 DANGER	This indicates situations in which improper handling may result in fatal or serious injury to persons or serious damage to property.
 WARNING	This indicates situations in which improper handling may result in serious injury to persons or serious damage to property.
 CAUTION	This indicates situations in which improper handling may result in minor injury to persons or minor damage to property.
NOTE	This indicates handling tips.

1-4. Checking standards and explosion-proof specifications

The product specifications will vary depending on the specific standards and explosion-proof certification. Check the actual product specifications before use. For CE marking models, refer to the “Declaration of Conformity” in the Appendix.

Check the affixed nameplate for product specifications.

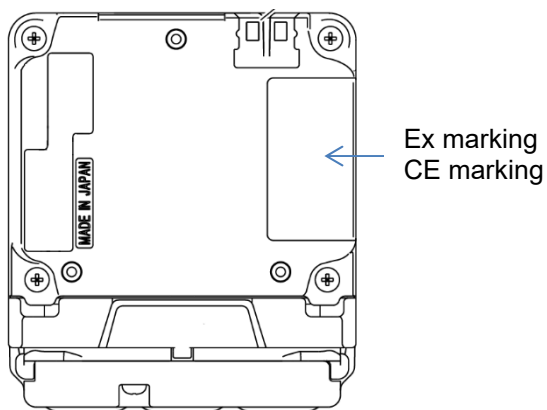

ATEX/IECEx,CE marking type name plate

Important Safety Information

To maintain the performance of the product and to ensure safe use, always observe the following DANGER, WARNING, and CAUTION instructions.

2-1. Danger information



DANGER

Explosion-proofing

- Do not modify or alter the circuitry or configuration.

Usage

- If measuring inside manholes or enclosed spaces, never lean over or look into the manhole or enclosed space. There is a danger that oxygen-deficient air or other gases may be discharged from such locations.

2-2. Warning information



WARNING

If an abnormality is discovered in the product

- If an abnormality is discovered in the product, contact Riken Keiki immediately. Visit our website for information on the nearest Riken Keiki office.
Website: <https://www.rikenkeiki.co.jp/>

Sensor handling

- Never attempt to disassemble the electrochemical type sensor inside the product. Electrolyte contained inside may cause inflammation if it comes into contact with the skin. There is also a risk of blindness if it comes into contact with the eyes. Electrolyte may discolor or decompose clothing if it comes into contact with clothing. If contact occurs, rinse the area immediately with plenty of water. Do not use any gas other than nitrogen as the balance gas when calibrating or adjusting an oxygen sensor.

Fresh air adjustment in the atmosphere

- When fresh air adjustment is performed in the atmosphere, check the atmosphere for freshness before starting. The presence of interference gases will make it impossible to adjust the product correctly, resulting in the danger of erroneous detection when actual gas leaks occur.

Action when a gas alarm occurs

- When a gas alarm occurs, this indicates an extremely dangerous situation. The user must take appropriate action after taking steps to ensure safety.

Battery level check

- Check the battery level before using the product. The battery may be depleted when the product is used for the first time or after extended periods without use. Charge the battery before use.
- If a low battery voltage alarm occurs, gas cannot be detected. If the alarm is issued during use, turn off the power and promptly charge the battery in a safe place.

Miscellaneous

- Gas cannot be detected if the sensor is covered with water such as rainwater. Do not use the product in rain or submerge it in water.
- When wearing the product, make sure that it is exposed to the air. If it is covered or blocked, correct measurement cannot be obtained, possibly resulting in accidents.
- Do not dispose of the product into fire.
- Do not attempt to wash the product, either in a washing machine or an ultrasonic cleaning machine.
- Do not block the buzzer sound opening. Doing so will muffle or silence the audible warning.
- The product is a personal gas monitor to be worn on the body. Therefore, before using the product in a confined space, suspend it with a separately prepared rope, tie it to the end of a rod or connect the suction pump unit RP-3R (sold separately) to detect the atmosphere from the outside of the confined space to confirm safety in advance.
- While conducting measurement in a confined space, do not lean over or look into the closed space. It may lead to dangers because oxygen-deficient air or other gases may blow out.

2-3. Caution information



CAUTION

- Do not use the product in locations where it may be exposed to oil or chemicals, etc.
 - Avoid using the product in locations where the product may be splashed with liquids such as oil and chemicals.
 - Do not place the product in locations where water or dirt accumulates. Placing the product in such locations may cause malfunction due to water or dirt ingress into the buzzer sound opening, etc.
- Do not use the product in locations where the temperature exceeds the range of operating temperatures.
 - The operating temperature range for the product is as follows. Avoid using the product at temperatures outside the operating range.
Continuous use environment: -20 °C to +50 °C
Temporary use environment: -40 °C to +60 °C
 - Avoid using the product for extended periods in locations where it is exposed to direct sunlight.
 - Avoid storing the product inside parked vehicles in hot weather.
- Adhere to the operating humidity range to prevent condensation forming inside the product. Condensation forming inside the product may cause clogging or gas adsorption, which may prevent accurate gas detection. Condensation must be avoided at all costs. In addition to the usage environment, carefully monitor the temperature and humidity of the sampling point to prevent condensation forming inside the product.
- Do not use walkie-talkies near the product.
 - Radio waves from walkie-talkies or other radio wave transmitting devices near the product may affect readings. If walkie-talkies or other radio wave transmitting devices are used, these must be used away from the product where they do not affect operation.
 - Do not use the product near devices that emit strong electromagnetic radiation (high-frequency or high-voltage devices).
- Verify that the operation status display is blinking before using the product.
If the operation status display is not blinking, gas cannot be detected properly.

Sensors

- Note that if combustible gas sensors are used in an environment where silicone compounds, halides, high concentrations of sulfides, or high concentrations of solvent gases are present, the sensor life may be reduced, sensitivity to combustible gases may deteriorate, and accurate readings may not be obtained. If use in such environments is unavoidable, use for the shortest possible time and allow the product to stand in fresh air after use. Confirm that the reading returns to normal and is stabilized.
- An oxygen concentration higher than a certain level is required in order for the combustible gas sensor <%LEL> in the product to correctly detect gases and display concentrations.
- Do not expose the product to sudden pressure fluctuations. Oxygen readings will vary temporarily, preventing accurate measurement.
- Do not use any gas other than nitrogen as the balance gas when calibrating or adjusting an oxygen sensor. Otherwise, oxygen reading errors will increase, preventing accurate measurement.



CAUTION

- Be sure to perform regular maintenance.
The product must be maintained regularly to ensure safety. Continuing to use the product without maintaining it will result in sensor sensitivity variations, preventing accurate gas detection.
- Miscellaneous
 - Pressing buttons unnecessarily may change the settings, preventing alarms from activating correctly. Avoid performing any operations not described in this operating manual.
 - Do not drop the product or subject it to impact. Doing so may degrade explosion-proof, waterproof, dustproof, and gas detection performance.
 - Do not use the product while charging it.
- Do not poke the buzzer sound opening or sensor openings with sharp-pointed items. Doing so may result in ingress of water or foreign matter, resulting in malfunctions or damage to the product.
- Do not block the buzzer sound opening with tape or other objects. This will prevent adjustment of the internal pressure of the product, which may result in malfunctions.
- Do not remove the panel sheet on the LCD display. Doing so will impair waterproof and dustproof performance.
- Do not cover the infrared port with labels or other objects. This will prevent infrared communication.
- Usage
 - The operating time will be reduced due to battery performance in cold environments.
 - The response of the LCD display may slow at low temperatures.
 - Always perform air calibration under conditions of pressure, temperature, and humidity similar to those in the operating environment and in fresh air.
 - Wait for the readout to stabilize before performing air calibration.
 - If there is a temperature difference of 15 °C or more between the storage and usage locations, turn on the power and allow the product to stand and acclimatize for about 10 minutes in an environment similar to the usage location before performing air calibration in fresh air.
 - When wiping the product clean, do not splash water on it or use organic solvents like alcohol and benzene. Doing so may discolor or damage the surfaces of the product.
 - After a period of extended storage, be sure to perform calibration before resuming use. For information on readjustment including calibration, please contact Riken Keiki.

2-4. Safety information

Necessary information for explosion proof construction of Model GX-3R.

Overview

The GX-3R can measure up to 4 gases using 3 sensors.

The GX-3R measures the combustible gases (LEL), oxygen (O₂), hydrogen sulfide (H₂S), and carbon monoxide (CO).

This model displays measurement results on an LCD and issue gas alarms (via LED and buzzer) as needed.

Gas sampling is by diffusion. The model does not have internal suction pumps.

Power sources

The GX-3R draws power from an integrated rechargeable Li-ion battery that is not user-replaceable. A dedicated AC adapter is used for recharging the Li-ion battery.

<ATEX/IECEX specification>

Explosion proof structure	Intrinsically safe explosion-proof construction and flame-proof enclosures
Specification for safety	Ex da ia I Ma , Ex da ia IIC T4 Ga (with combustible gas sensor NCR-6309) Ex ia I Ma , Ex ia IIC T4 Ga (without combustible gas sensor NCR-6309)
	 I M1 Ex da ia I Ma, II 1 G Ex da ia IIC T4 Ga (with combustible gas sensor NCR-6309) I M1 Ex ia I Ma, II 1 G Ex ia IIC T4 Ga (without combustible gas sensor NCR-6309)
Ambient temperature range	-40°C to +60°C
Ambient temperature range (for charging)	0°C to +40°C
Electrical data	<ul style="list-style-type: none">• Lithium-ion battery: Maxell rechargeable battery model no. ICP463048XS• The battery should be charged with the dedicated AC adapter or by power from a IEC60950-certified SELV power source, or IEC62368-1-certified ES1 power source. The maximum voltage from the charger shall not exceed 6.3Vdc.
Certificate numbers	<ul style="list-style-type: none">• IECEx : IECEx DEK 17.0050 X• ATEX : DEKRA 17 ATEX 0103 X
List of standards	<ul style="list-style-type: none">• IEC 60079-0:2017• IEC 60079-1:2014-06• IEC 60079-11:2011• EN IEC 60079-0:2018• EN60079-1:2014• EN60079-11:2012• EN50303:2000



WARNING

- Do not attempt to disassemble or modify the instrument.
- The combustible gas sensor NCR-6309, to measure LEL, is the only part of this Gas Monitor system with flame - proof construction.
- This product is an explosion-proof product and is not to be disassembled or modified with the exception of specified parts.
- NCR-6309 must not be exposed to ultraviolet light.
- This product integrates a sensor having flameproof construction. If assembly is not performed as specified, explosion protection performance will be compromised. When replacing the sensor and filter, properly install genuine parts and torque to specification.
- If the enclosure is damaged it shall be repaired before further use.
- The Sensor shall not be exposed to ultraviolet light or used in equipment in which it is not fully enclosed.
- Do not charge in a hazardous location.
- Do not charge the unit with a non-genuine charger.

Group I Additional Specific Condition

- Do not give strong force or shock to NCR - 6309. There is a danger that the flame - proof performance will be damaged due to breakage etc. This sensor uses flame-proof conditions of "low" possibility of mechanical damage.
- The enclosures shall be protected against exposure to hydraulic liquids, oil or grease.

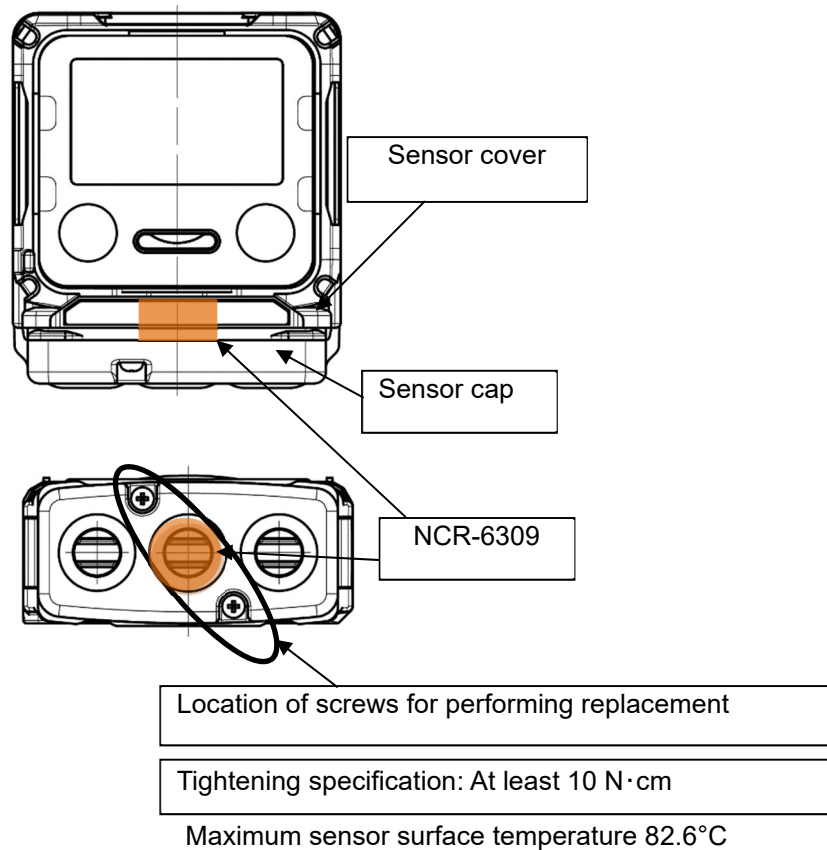

Instruments No.

INST. No. 00 0 000 0000 00
A B C D E

- A: Year of manufacture (0 to 9)
- B: Month of manufacture (1 to 9 for Jan.-Sep.; XYZ for Oct., Nov., Dec.)
- C: Manufacturing lot
- D: Serial number
- E: Factory codes



RIKEN KEIKI Co., Ltd.
2-7-6 Azusawa, Itabashi-ku, Tokyo, 174-8744, Japan
Phone: +81-3-3966-1113
Fax: +81-3-3558-9110
E-mail: intdept@rikenkeiki.co.jp
Website: <https://www.rikenkeiki.co.jp>

Product Configuration

3-1. Main unit and standard accessories

Open the box and packaging and inspect the product and accessories.
If anything is missing, contact Riken Keiki.

Main unit

For detailed information on the names and functions of product parts and the LCD display, see “3-2. Part names and functions” on page 16.

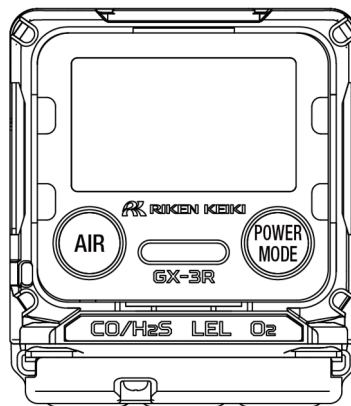

GX-3R main unit

Standard accessories

AC adapter
×1

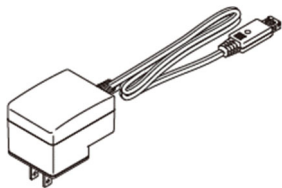

Rubber protection
cover
×1

Protects the product
from impact if it is hit
by something or
dropped.

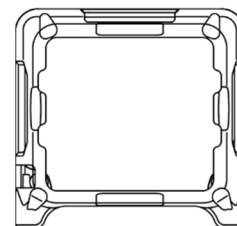

Alligator clip
×1

Allows attaching the
product to a pocket.
* ATEX/IECEX
specification only

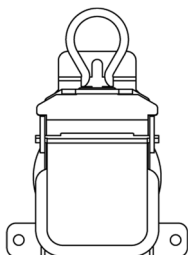

Calibration adapter
(simple type)
×1

Used to perform gas
calibration and bump
test.
* ATEX/IECEX
specification only

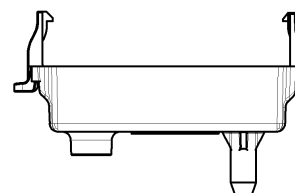

Hand strap
×1



3-2. Part names and functions

This section describes the names and functions of the various parts of the main unit and the LCD display.

Main unit

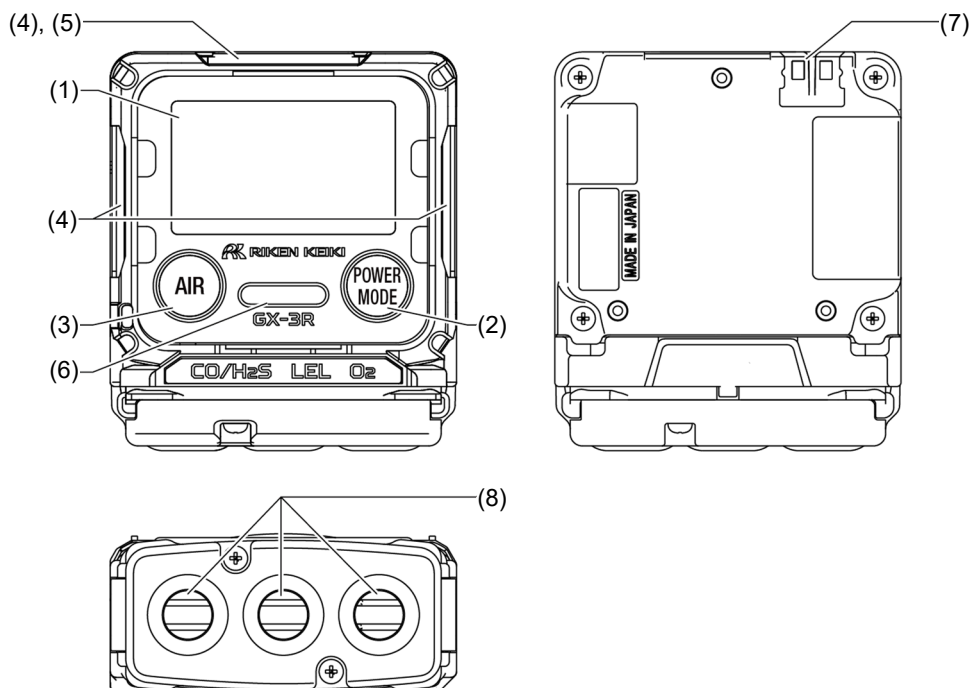

Name	Main function
(1) LCD display	Displays information such as gas type and gas concentration.
(2) POWER/MODE button	Turns the power on and off. This button is also used to confirm settings in setting mode.
(3) AIR button	Performs air calibration in measurement mode. This button is also used to select settings in setting mode.
(4) Alarm LED arrays	The lamps flash red when an alarm occurs.
(5) Infrared communication port	This is used for data communication with a PC when using a data logger management program.
(6) Buzzer sound opening	Emits operating and alarm sounds. (Do not block.)
(7) Battery charging contact	Contact for connecting the charger (EPU15-102-L6)
(8) Sensors	Sensors are installed for detecting individual gases.



CAUTION

- Do not poke the buzzer sound opening or sensor openings with sharp-pointed items. Doing so may result in ingress of water or foreign matter, resulting in malfunctions or damage to the product.
- Do not remove the panel sheet on the LCD display. Doing so will impair waterproof and dustproof performance.
- Do not cover the infrared communication port with labels or stickers. This will prevent infrared communication.
- Do not block the buzzer sound opening with tape or other objects. This will prevent adjustment of the internal pressure of the product, which may result in malfunctions.

NOTE

- In this operating manual, buttons that have multiple functions are described as follows in the operational procedures:
 Example: "POWER/MODE button" is described as follows:
 - POWER button when turning the power on and off
 - MODE button when confirming settings

LCD display

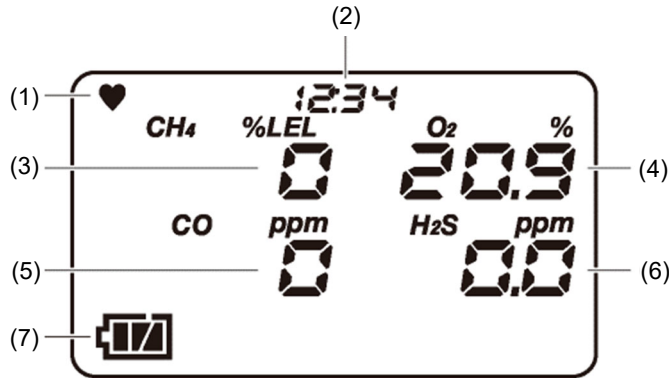

Name	Main function
(1) Operation status display	Indicates the operation status. Blinks when normal.
(2) Clock display	Displays the time.
(3) Combustible gas concentration	Displays gas concentrations as numerical readouts. The concentration readout is updated every second for sensors other than the combustible gas sensor. The combustible gas concentration readout is updated every five seconds (every 15 seconds for long-life battery operation).
(4) Oxygen concentration	
(5) Carbon monoxide concentration	
(6) Hydrogen sulfide concentration	
(7) Battery level icon	Indicates battery levels. See NOTE below for a guide to battery level indications.

NOTE

- Approximate battery levels are indicated as follows:
 - Sufficient
 - Low
 - Needs charging.
 The battery icon will blink if battery levels drop even further.
- If the bump test expiration date display setting is enabled, "✓" is displayed in the upper left of the LCD until the bump test expiration date. For more information on the bump test expiration date display setting, see "6-4-3. Calibration expiration date setting" on page 44.
- If the long-life battery function is enabled, "L" is displayed in the upper left of the LCD.
- "M" is displayed in the upper left of the LCD when user mode is selected.

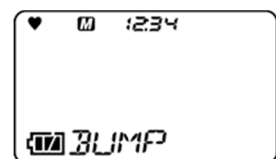
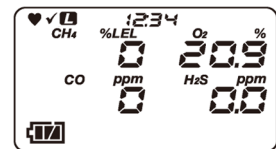

4

Alarm Activation

4-1. Gas alarm activation

<Alarm types>

A “gas alarm” is triggered if the concentration of the detected gas reaches or exceeds the alarm setpoints shown in the following table. (Self-latching)

Gas alarm types include the first alarm (WARNING), second alarm (ALARM), third alarm (ALARM H), TWA alarm, STEL alarm, OVER alarm (over scale), and M OVER alarm (minus sensor failure).

Gas alarms are prioritized as follows:

First alarm < second alarm < third alarm < M OVER alarm < OVER alarm < integrated alarm point < TWA alarm < STEL alarm

<Default settings>

Item	Measured gas	Combustible gas	O ₂	CO	H ₂ S
		HC or CH ₄			
Measurement range		0 to 100 %LEL	0 to 25 %	0 to 500 ppm	0 to 30 ppm
Service range		-	25 to 40 %	500 to 2,000 ppm	30 to 200 ppm
Minimum resolution		1 %LEL	0.1 %	1 ppm	0.1 ppm
Alarm setpoint (General ATEX/IECEX specification)		1st alarm: 10 %LEL 2nd alarm: 25 %LEL 3rd alarm: 50 %LEL OVER alarm: 100 %LEL MOVER alarm: -10%LEL	L: 19.5 % LL: 18.0 % H: 23.5 % OVER alarm:40.0% MOVER alarm: -1.0vol%	1st alarm: 25 ppm 2nd alarm: 50 ppm 3rd alarm: 1,200 ppm TWA alarm: 25 ppm STEL alarm: 200 ppm OVER alarm:2,000 ppm MOVER alarm: -50ppm	1st alarm: 5.0 ppm 2nd alarm: 30.0 ppm 3rd alarm: 100.0 ppm TWA alarm: 1.0 ppm STEL alarm: 5.0 ppm OVER alarm: 200.0 ppm MOVER alarm: -10.0ppm

NOTE

- The default settings are as described in the table above.
- The alarm setpoints indicated for the first alarm (WARNING), second alarm (ALARM), third alarm (ALARM H), TWA alarm, and STEL alarm in the table above can be changed. For information on how to change the alarm setpoints, see “6-4-5. Alarm setpoint setting” on page 52. (For items with “-” shown, the setpoint cannot be changed.)

<Gas alarm buzzer sounding and lamp flashing patterns>

When a gas alarm occurs, the user is notified by the buzzer sounding, alarm LED array flashing, and vibration, in two stages.

The individual operations are as follows:

Alarm type	First alarm	Second alarm	Third alarm	TWA alarm	STEL alarm	OVER alarm	M OVER alarm
Buzzer sounding	Repeated alternate strong and weak beeps at about 1-second intervals: "Beep, beep"	Repeated alternate strong and weak beeps at about 0.5-second intervals: "Beep, beep, beep, beep"	Repeated alternate strong and weak beeps at about 0.5-second intervals: "Beep, beep, beep, beep"	Repeated alternate strong and weak beeps at about 1-second intervals: "Beep, beep"	Repeated alternate strong and weak beeps at about 1-second intervals: "Beep, beep"	Repeated alternate strong and weak beeps at about 0.5-second intervals: "Beep, beep, beep, beep"	Repeated intermittent beeps at about 1-second intervals: "Beep, beep"
Alarm LED array flashing	Repeated flashing at about 1-second intervals	Repeated flashing at about 0.5-second intervals	Repeated flashing at about 0.5-second intervals	Repeated flashing at about 1-second intervals	Repeated flashing at about 1-second intervals	Repeated flashing at about 0.5-second intervals	Repeated flashing at about 1-second intervals
Vibration	Vibration when alarm occurs						None

For gases other than oxygen: "Alarm Pattern (H-HH-HHH)"

For oxygen: "Alarm Pattern (L-LL-H)"

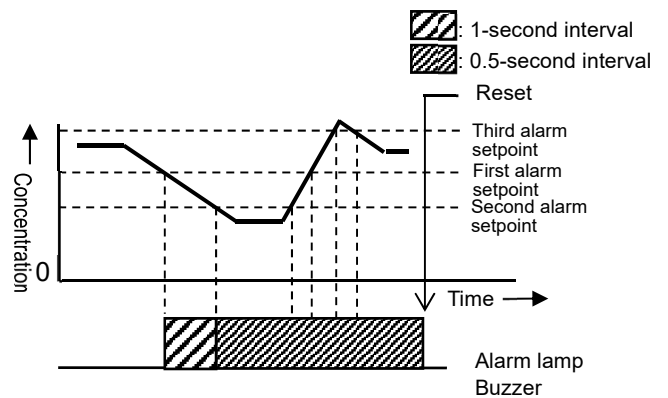
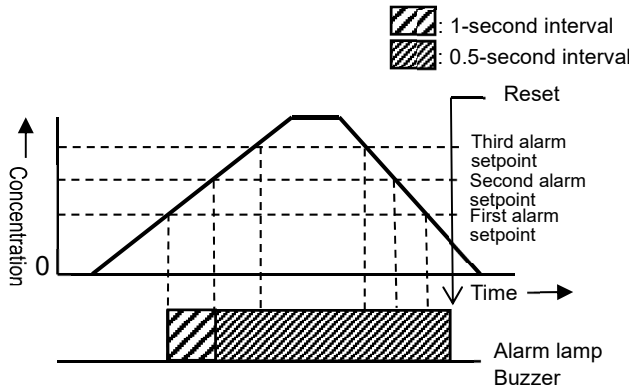

<Gas alarm display>

If a gas alarm occurs, the alarm type is indicated at the bottom of the screen, and the corresponding gas concentration display blinks.

If the detection range is exceeded (over scale), "OVER" blinks at the bottom of the screen and "〇〇〇" blinks in the gas concentration display area.

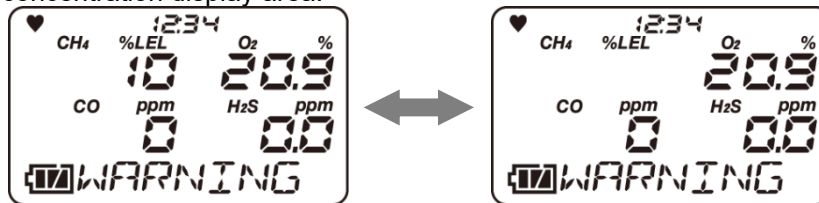

Display example Methane (CH4) concentration: 10 %LEL First alarm triggered

Alarm type	First alarm	Second alarm	Third alarm	TWA alarm	STEL alarm	OVER alarm	M OVER alarm
LCD display	"WARNING" appears at the bottom of the screen, and the gas concentration value blinks.	"ALARM" appears at the bottom of the screen, and the gas concentration value blinks.	"ALARM H" appears at the bottom of the screen, and the gas concentration value blinks.	"TWA" appears at the bottom of the screen, and the gas concentration value blinks.	"STEL" appears at the bottom of the screen, and the gas concentration value blinks.	"OVER" appears at the bottom of the screen, and "〇〇〇" blinks in the gas concentration value display area.	"M OVER" appears at the bottom of the screen, and "〇〇〇" blinks in the gas concentration value display area.



WARNING

- A gas alarm indicates the presence of extreme danger. The user must take appropriate action after taking appropriate steps to ensure safety.

NOTE

- Responses to an alarm can be checked using the alarm test in display mode. Note, however, that the gas concentration value will not blink in alarm tests.

4-2. Fault alarm activation

A fault alarm is triggered if an abnormality is detected in the product. (Self-latching)

Fault alarm types include system abnormality, clock abnormality, battery voltage abnormality, and sensor abnormality.

If a fault alarm occurs, the user is notified by the buzzer sounding and alarm LED array flashing.

- Buzzer sounding: Repeated intermittent beeps at about 1-second intervals “Beep-beep, beep-beep”
- Alarm LED array flashing: Repeated flashing at about 1-second intervals

The following shows typical fault alarm displays:

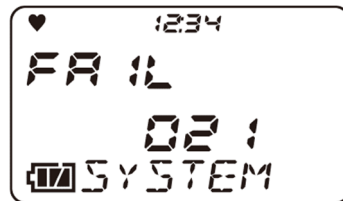

System abnormality

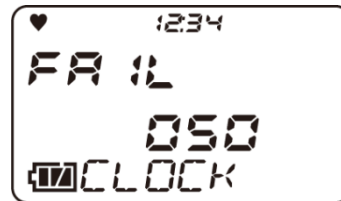

Clock abnormality



Battery voltage abnormality

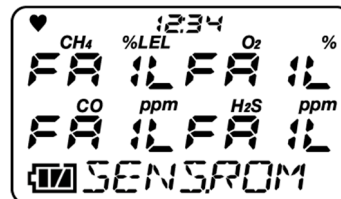

Sensor abnormality

If a fault alarm occurs, determine the cause and take appropriate action.

If the problem lies with the product and the fault occurs repeatedly, contact Riken Keiki immediately.

NOTE

- For more information on malfunctions (error messages), see “ Troubleshooting” on page 81.

Usage Instructions

5-1. Before using the product

The operating precautions apply to both first-time users and those who have previously used the product. Ignoring these precautions may damage the product and result in inaccurate gas detection.

5-2. Preparing startup

Check the following before starting gas detection:

- Confirm that the battery level is sufficient.
- Confirm that the filter inside the product is neither contaminated nor clogged.

NOTE

- If the settings for the product have been altered from an external device, be sure to confirm that the settings have been altered correctly.

5-2-1. Charging the lithium ion battery

Before using the product for the first time or if battery levels of the lithium ion battery are low, charge using the provided charger, as described below.



DANGER

- Charge the battery using the provided charger in a safe place.
- Charge the battery at ambient temperatures between 0 °C and 40 °C.



CAUTION

- Be sure to turn off the power for the product before charging the battery.
- Do not use the product while charging the battery. The measurements obtained will not be correct. Additionally, doing so will degrade the battery more quickly and reduce battery life.
- The charger is neither waterproof nor dustproof. Do not charge the battery while the product is wet.
- The charger is not explosion-proof.
- The main unit may get hot during charging. This does not indicate an abnormality.
- The main unit will grow warmer while charging. Once charging is completed, wait at least 10 minutes before use. Using the product while it is still hot may result in incorrect measurements.
- When fully charged, the battery cannot be charged.
- Always unplug the charger from the outlet when not in use.

<Charging the lithium ion battery>

- 1 Insert the DC plug of the charger into the battery charging contact of the main unit.**

Insert the DC plug cable from the top of the main unit aligning with the groove.

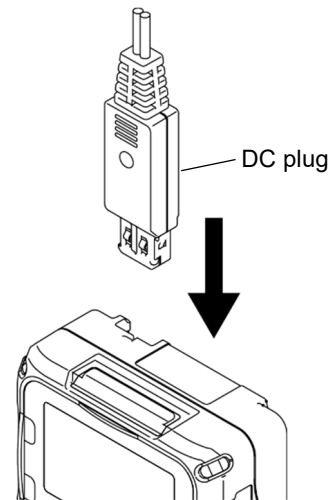

- 2 Plug the charger into the outlet.**

When the charger is connected, the charging indicator lamp lights up in green. When charging starts, the lamp lights up in orange. (Full charge requires about three hours at maximum.)

Once charging is completed, the charging indicator lamp lights up in green.

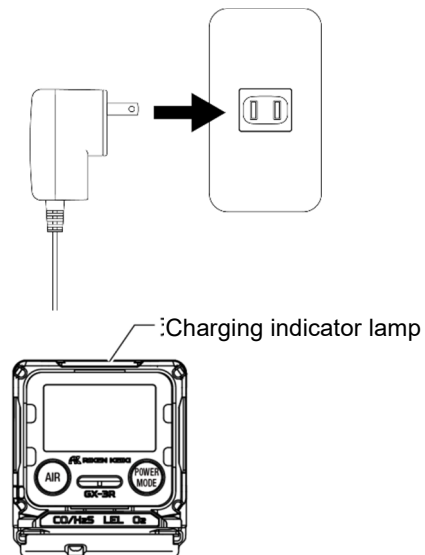

- 3 Unplug the charger from the outlet when charging is complete.**

5-3. Startup

When the power is turned on, various settings including date and time and alarm setpoints are displayed, and then the measuring mode screen is displayed.

Turning on the power

Hold down the **POWER button (for at least 3 seconds) until the buzzer blips.**

The power turns on.

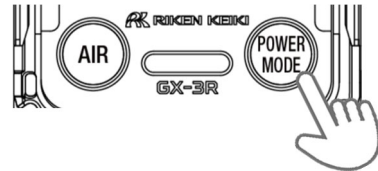

The entire LCD display lights up.

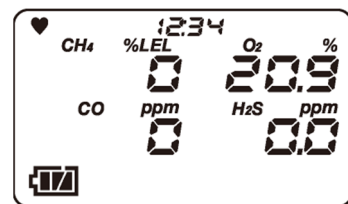

NOTE

- When the power is turned on, the LCD, lamps and buzzer start to operate and the product vibrates. Before using the product, check that these operations function correctly.

Screen transition from powering on to displaying measurement screen

When the power is turned on, the LCD display changes automatically as shown below before the measurement screen is displayed.

<Display examples: Default settings> (about 40 seconds)

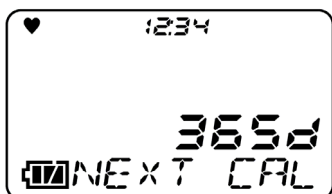

Calibration expiration date display screen

* Displayed on general ATEX/IECEX specification only

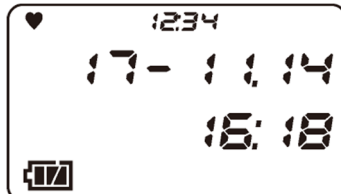

Date and time display

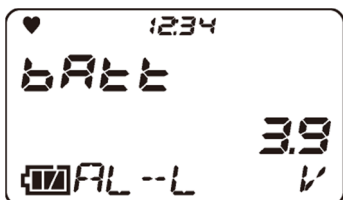

Battery level/alarm pattern display

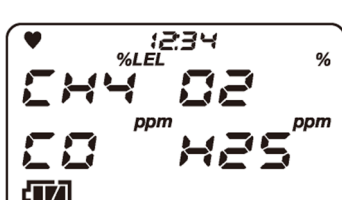

Detection target gas display

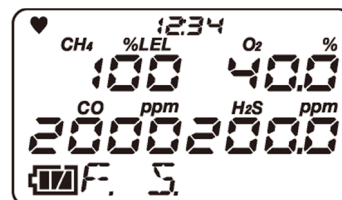

Full scale display

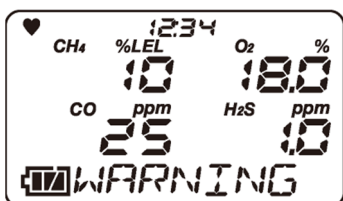

First alarm setpoint display



Second alarm setpoint display

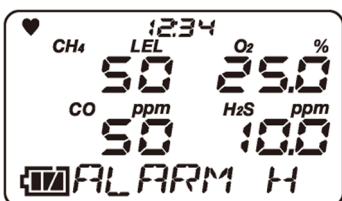

Third alarm setpoint display

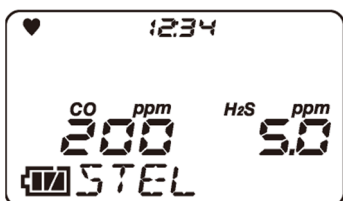

STEL alarm setpoint display

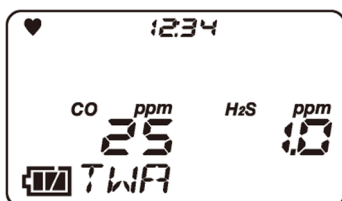

TWA alarm setpoint display

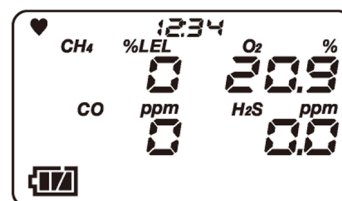

Measurement screen

The buzzer blips twice and then the measurement screen is displayed.



CAUTION

- Only for ATEX/IECEX specification
When the calibration date has expired, indicates that the calibration has expired when the power is turned on. The operation after calibration expiration depends on its setting.
For information on the calibration procedure, see "7-2. Calibration" on page 63.
CONFIRM: Allows the user to confirm and select whether to proceed to measurement mode or to Auto calibration cylinder setting.
CANT USE: Measurement mode is not available. Proceed to Auto calibration cylinder setting by pressing the button or after 6 seconds.
NO EFFECT: Indicates that calibration has expired and allows the user to select whether to proceed to Auto calibration cylinder setting by pressing the button or to measurement mode after 6 seconds when there is no action.



CAUTION

- When the bump test date has expired, indicates that the bump test date has expired when the power is turned on. The operation after bump test expiration depends on its setting.
For information on the bump test procedure, see “7-3. Bump test” on page 72.
 - CONFIRM: Allows the user to confirm and select whether to proceed to measurement mode or to Bump test cylinder setting.
 - CANT USE: Measurement mode is not available. Proceed to Bump test cylinder setting by pressing the button or after 6 seconds.
 - NO EFFECT: Indicates that calibration has expired and allows the user to select whether to proceed to Bump test cylinder setting by pressing the button or to measurement mode after 6 seconds when there is no action.
- With models that detect combustible gases, the screen shown on the right may be displayed with the buzzer sounding and lamp flashing after the battery level and alarm pattern are displayed.
If this screen is displayed, some combustible gases cannot be converted using the combustible gas conversion function. For information on the types of gases that cannot be converted, see “6-2-2. Combustible conversion gas selection” on page 35. If the screen shown on the right appears, the alarm can be temporarily reset by pressing the **MODE** button, but the combustible gas sensor should be replaced with a new one promptly.
- If any abnormality is detected in the sensor, “FAIL” appears in place of the measured value just before the measurement screen is displayed, and a sensor abnormality alarm is triggered. If this occurs, press the **MODE** button to temporarily reset the sensor abnormality alarm. However, the alarm cannot be reset if there is an abnormality in all of the sensors. After the alarm is reset, “- - -” appears in the concentration display area of the gas for which the sensor abnormality occurred, and detection will not be possible for that gas type. Contact Riken Keiki immediately.
- After startup, perform “5-4. Air calibration” on page 27.

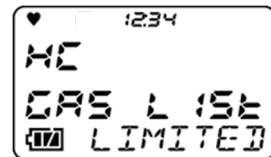

NOTE

- If there is an abnormality in the built-in clock, a “FAIL CLOCK” fault alarm may be triggered. If this occurs, press the **MODE** button. The fault alarm will be temporarily reset, and measurement will be started with the clock time remaining incorrect.

Lunch break

When the lunch break setting is enabled, the screen is displayed with a five-second countdown to allow the user to confirm whether to retain the TWA and PEAK values from the last time the power was turned off and continue measurement or to reset the values when the power is turned on. Pressing the **MODE** button retains the measurement data, and pressing the **AIR** button resets the measurement data. If no button is pressed for five seconds, the measurement data is automatically retained.

Bump test expiration date

When the bump test expiration date setting is enabled, the number of days remaining after the last bump test date until a specified setting date is displayed when the power is turned on. For information on the bump test expiration date setting, see “6-4-4. Bump test setting” on page 47.

Calibration notification display

With ATEX/IECEX specifications only, the calibration expiration date appears when the power is turned on. The calibration expiration date display indicates the number of days remaining after the last calibration date until a specified setting date. For details, see “6-4-3. Calibration expiration date setting” on page 44.

Date and time

Displays the date and time. The date and time can be set by following the instructions described in “6-4. User mode settings” on page 44.

If an IrDA communication partner device is brought close to the product, it switches to communication mode. Pressing the **AIR** and **MODE** buttons together also switches to communication mode, even when no communication partner device is nearby.

Battery level/alarm pattern

Displays the battery level (voltage) and alarm pattern setting (AL-L <self-latching>) on the screen. If an IrDA communication partner device is brought close to the product, it switches to communication mode. Pressing the **AIR** and **MODE** buttons together also switches to communication mode, even when no communication partner device is nearby.

Detection target gas

Displays the detection target gas. The gas currently being converted is displayed at the bottom of the screen if a combustible gas is being converted.

Full scale

Displays the full-scale value of the detection target gas. IEC or ISO is displayed in the full-scale display area if IEC or ISO LEL values are set.

Second alarm setpoint

Displays the second alarm setpoint for the detection target gas.

Third alarm setpoint

Displays the third alarm setpoint for the detection target gas.

STEL alarm setpoint (TWA and STEL are displayed only on models that detect gases other than combustible gases and oxygen.)

Displays the STEL alarm setpoint for the detection target gas. The STEL value refers to the concentration of a toxic substance that does not adversely affect the user's health with 15-minute continuous exposure, provided that daily exposures do not exceed the TWA value.

Not displayed on models where CO and H₂S are not included in the detection target gases.

TWA alarm setpoint (TWA and STEL are displayed only on models that detect gases other than combustible gases and oxygen.)

Displays the TWA alarm setpoint for the detection target gas. The TWA value refers to the time-weighted average concentration limit of a toxic substance for a normal 8-hour workday and a 40-hour workweek to which almost all users may be repeatedly exposed without adverse health effect.

5-4. Air calibration

Air calibration refers to zero adjustment required to ensure accurate measurement of gas concentrations.



WARNING

- When air calibration is performed in the atmosphere, check the atmosphere for freshness before starting. The presence of interference gases will make it impossible to perform air calibration correctly and potentially result in hazardous conditions in the event of actual gas leaks.



CAUTION

- After start-up, perform air calibration before using the product for gas detection.
- Always perform air calibration under conditions of pressure, temperature, and humidity similar to those in the operating environment and in fresh air.
- Wait for the readout to stabilize before performing air calibration.
- If there is a temperature difference of 15 °C or more between the storage and usage locations, turn on the power and allow the product to stand and acclimatize for about 10 minutes in an

Air calibration procedure

- 1 **Hold down the AIR button on the measurement mode screen.**

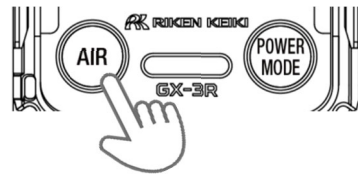

The air calibration screen appears.
Keep the AIR button pressed for as long as the screen shown on the right is displayed.
Air calibration will not be performed if you release the button before the screen is displayed or while it is displayed.

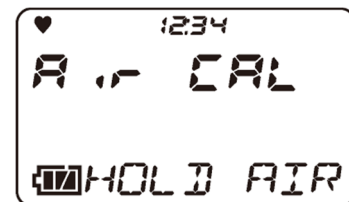

- 2 **Release the AIR button once the screen shown on the right appears.**



If air calibration has been successfully completed, the display automatically returns to the measurement mode screen.

NOTE

- If air calibration fails, "FAIL" appears in the concentration display area for the faulty sensor. Press the MODE button to reset the fault alarm (calibration failure). Resetting the alarm displays the value before calibration.

5-5. Gas detection



DANGER

- If measuring inside manholes or enclosed spaces, never lean over or look into the manhole or enclosed space. There is a danger that oxygen-deficient air or other gases may be discharged from such locations.



WARNING

- When air calibration is performed in the atmosphere, check the atmosphere for freshness before starting. If interference gases are present, it will not be possible to calibrate the product correctly, resulting in danger if actual gas leaks occur.
- A gas alarm indicates the presence of extreme danger. The user must take appropriate action based on the situation.
- If the battery voltage drops, gas cannot be detected. If a low battery voltage alarm occurs during use, turn off the power and promptly charge the battery in a safe place.
- Do not block the buzzer sound opening. Doing so will make the alarm hard to hear.



CAUTION

- Check the settings before starting gas detection.

5-5-1. Basic operating procedures

Turn on the power to proceed to the measurement mode screen.

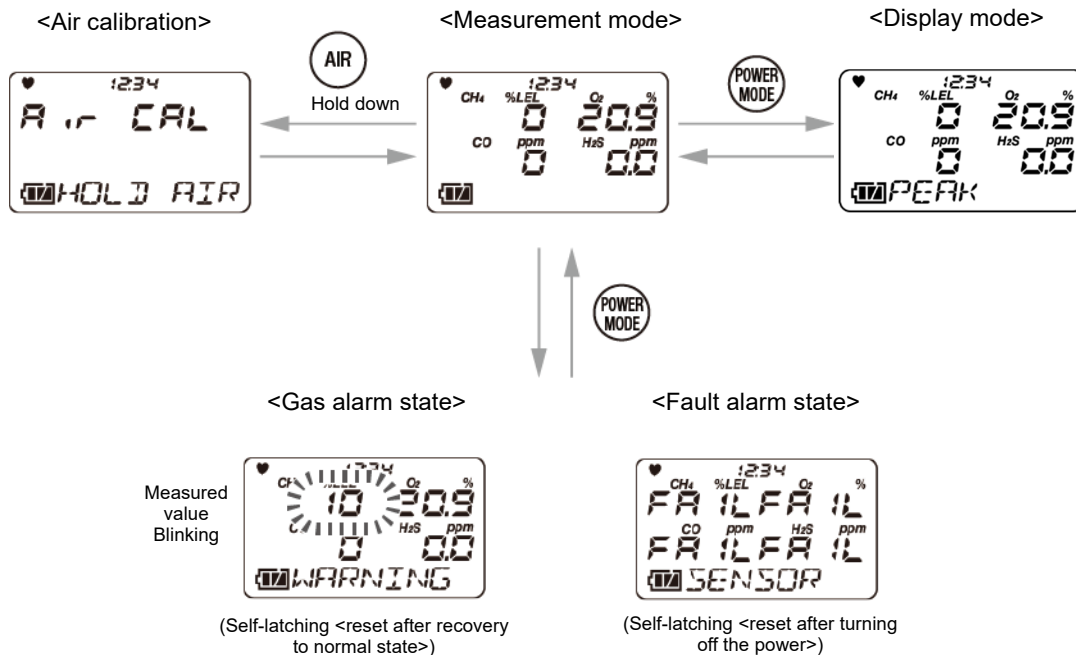

5-5-2. Measurement mode

In measurement mode, read the values on the LCD display.

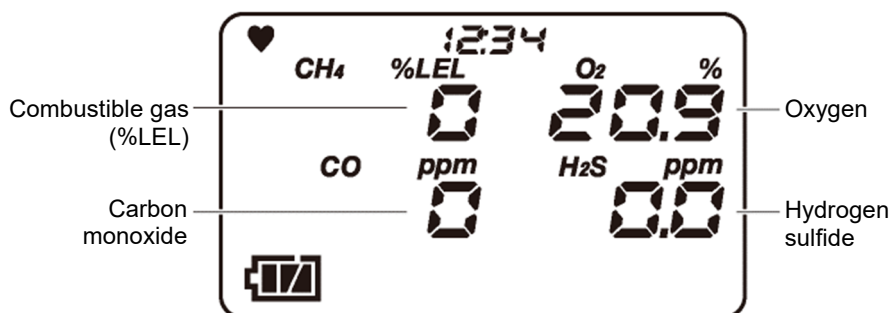

Display example



CAUTION

- Note that if combustible gas sensors are used in an environment where silicone compounds, halides, high concentrations of sulfides, or high concentrations of solvent gases are present, sensor life may be reduced, sensitivity to combustible gases may deteriorate, and accurate readings may not be obtained. If use in such environments is unavoidable, use for the shortest possible time and allow the product to stand in fresh air after use. Confirm that the reading returns to normal and is stabilized.
- An oxygen concentration higher than a certain level is required in order for the combustible gas sensor <%LEL> in the product to correctly detect gases and display concentrations.
- Do not expose the product to sudden pressure fluctuations. Oxygen readings will vary temporarily, preventing accurate measurement.
- Do not use any gas other than nitrogen as the balance gas when calibrating or adjusting an oxygen sensor. Otherwise, oxygen reading errors will increase, preventing accurate measurement.
- If the product is exposed to highly adsorptive gas, allow it to stand in fresh air. Confirm that the reading returns to zero before use.
- The hydrogen sulfide (H₂S) sensor may exhibit temporary fluctuations if exposed to sudden temperature variations. Allow the product to stand and acclimatize in the ambient atmosphere.

NOTE

- The gas currently being converted is displayed at the bottom of the screen if a combustible gas is being converted.
- The operating time will be reduced due to battery performance in cold environments.
- The response of the LCD display may slow at low temperatures.
- If the product is exposed to a combustible gas at concentrations of 100 %LEL or above, some adsorbed gas may remain in the filter. After drawing in high-concentration combustible gas, always allow the product to stand in fresh air. Perform air cleaning until the reading returns to around zero to remove any adsorbed gases. Performing air calibration before a complete cleaning will result in inaccurate adjustments, with potential adverse effects on measurement. Locking over will occur if 100 %LEL is detected. This will not be reset until either the oxygen concentration decreases or you press the **MODE** button.
- The zero point for carbon monoxide (CO) and hydrogen sulfide (H₂S) sensors may fluctuate at low or high temperatures. If this occurs, perform air calibration in the ambient atmosphere.

- The carbon monoxide sensor (ESR-A1CP) includes a correction function to reduce interference due to hydrogen. This function works for hydrogen concentrations up to 2,000 ppm. If hydrogen is detected at a concentration of 2,000 ppm or higher, "H2" and "rich" are displayed alternately in the concentration display area. While measurement can continue, large errors will arise with carbon monoxide concentration readings due to the significant effects of hydrogen interference.

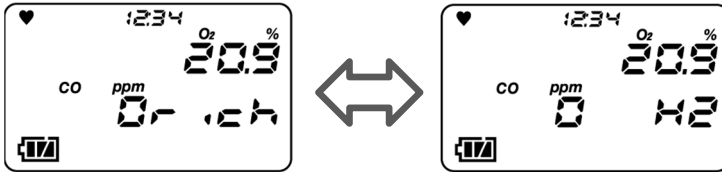

Concentration display: rich

Concentration display: H2

- Sensitivity may be reduced temporarily if the carbon monoxide sensor comes into contact with gas at concentrations exceeding its measurement range. If the sensor has come into contact with high-concentration gas, be sure to allow it to stand in fresh air and perform air cleaning.
- Sensitivity may be reduced temporarily if the hydrogen sulfide (H₂S) sensor comes into contact with gas at concentrations exceeding its measurement range. If the sensor has come into contact with high-concentration gas, be sure to allow it to stand in fresh air and perform air cleaning.
- If you are measuring for 20 minutes or more outside the operating temperature range, temperature range error will be triggered. If temperature range error is triggered, leave it for 5 minutes or more within the operating temperature range or turn off the power of the main unit.

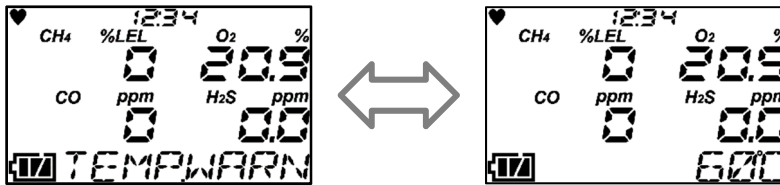

5-6. Turning off the power



CAUTION

- If the concentration display does not return to zero (or 20.9 % for the oxygen concentration display) after measurement is completed, allow the product to stand in fresh air until the display returns to zero before turning off the power.

Hold down the **POWER** button.

To turn off the power, wait for the display to return to zero (or 20.9 % for oxygen) in a safe place, then hold down the **POWER** button.

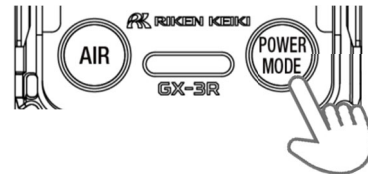

The buzzer blips three times and “TURN OFF” appears on the display before the power turns off.

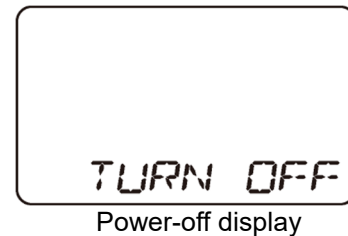

NOTE

- When turning off the power, hold down the button until the display turns off.



CAUTION

- If the product has become dirty, wipe it with a rag or cloth soaked in water and firmly wrung out.
- When wiping the product clean, do not use organic solvents like alcohol or benzene or commercially available cleaners.

6

Setting Procedure

6-1. Display mode

Display mode lets users review and change various display settings and perform other operations. Changed settings are saved.

6-1-1. Displaying display mode

Press the **MODE button on the measurement mode screen.**

Pressing the **MODE** button displays the various screens in sequence.

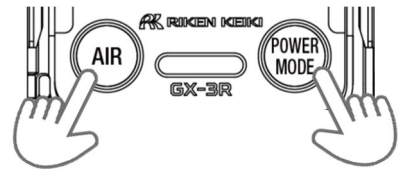

To change a setting, press the **AIR button.**

The setting screen is displayed.

Press the **MODE button once settings are complete.**

The settings are saved and the display returns to the previous screen.

To return to the measurement mode screen, press the **MODE button several times in display mode.**

NOTE

- If no action is taken for about 20 seconds, the display will return to the measurement screen.
- To test the alarm, press the **AIR** button and **MODE** button at the same time while an alarm setpoint is displayed.
- Hold down the **AIR** button and **MODE** button at the same time in display mode to return to measurement mode.
- To cancel before finalizing changes to the settings, hold down the **AIR** button and **MODE** button at the same time. The display returns to display mode.

6-1-2. Display mode display details

Screen notation (Setting item)	Display contents	LCD display	Reference page
PEAK (PEAK display/PEAK reset)	Displays the maximum gas concentration (or minimum oxygen concentration) detected since the power was turned on.	The LCD display shows a heart icon in the top left corner. It displays four gas concentrations: CH4 at 12.34 %LEL, CO at 0 ppm, O2 at 20.9 %, and H2S at 0.00 ppm. At the bottom left, there is a 'PEAK' indicator with a small bar graph icon.	Hold down the AIR button to jump to the PEAK value clearing screen on page 34.

Screen notation (Setting item)	Display contents	LCD display	Reference page
STEL (STEL display) * Displays only CO and H ₂ S.	Displays the STEL value since the power was turned on. The STEL value refers to the sum of 15 pieces of average value data for measured values over a period of 60 seconds divided by 15. The value is refreshed every 60 seconds.		----
TWA (TWA display) * Displays only CO and H ₂ S.	Displays the TWA value since the power was turned on. The TWA value refers to the integrated average value of measured values over a period of 60 seconds divided by 480. The value is refreshed every 60 seconds.		----
HC GAS (Combustible converting gas selection) * Displayed only on models that detect combustible gases	Selects the conversion gas from the list of gases preregistered in the product.		Press the AIR button to jump to the setting screen on page 35.
LONG.BATT (Long-life battery setting) * Displayed only on models that detect combustible gases	Enables/disables the long-life battery setting.		Press the AIR button to jump to the setting screen on page 37.
CAL DATA (Calibration data display) * Displayed on general ATEX/IECEX specification only	Displays the calibrated gas type and the calibration date.		Press the AIR button to jump to the display screen on page 38.
BUMP DATA (Bump data display)	Displays the bump test gas type and the test date.		Press the AIR button to jump to the display screen on page 39.
DATE Date, time, and temperature display	Displays the date, time, and temperature.		----
ALARM-PT (Alarm setpoint display)	Displays various alarm setpoints.		Press the AIR button to jump to the confirmation screen on page 40.

NOTE

- The previously measured PEAK and TWA values retained the last time the power was turned off are displayed when the lunch break function is enabled.
- HC GAS (combustible conversion gas selection) is not displayed for calibration gas types other than CH₄ or i-C₄H₁₀.
- Bump data is displayed if the bump test expiration date display is enabled in user mode.
- Calibration data is displayed if the calibration expiration date display is enabled in user mode.
- The temperature displayed in the date and time and temperature display is the internal temperature of the product. This value differs from the actual ambient temperature.

6-2. Display mode settings

Switch to display mode from the measurement screen, and check and change settings in display mode.

6-2-1. Clearing PEAK value display

This clears the PEAK value (the maximum gas concentration or minimum oxygen concentration measured since the power was turned on).

1 Press the **MODE button on the measurement screen to display the **PEAK** screen.**

2 Hold down the **AIR button.**

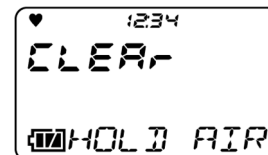
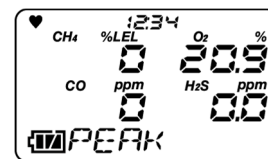

3 Release the **AIR button once **“RELEASE”** is displayed on the screen.**



The PEAK value is cleared and “END” appears before the display returns to the screen in Step 1.

6-2-2. Combustible conversion gas selection

Combustible gas measurements can be displayed as a concentration converted to a gas registered in the product.

The following combustible gases can be converted:

<Combustible conversion gas list>

Conversion gas	Gas name displayed	Gas conversion		Conversion when conversion is restricted
		CH4	i-C4H10	
Methane	CH4	-	×	○
Isobutane	i-C4H10	○	-	○
Hydrogen	H2	○	○	○
Methanol	CH3OH	○	○	×
Acetylene	C2H2	○	○	○
Ethylene	C2H4	○	○	○
Ethane	C2H6	○	×	○
Ethanol	C2H5OH	○	○	×
Propylene	C3H6	○	○	○
Acetone	C3H6O	○	○	×
Propane	C3H8	○	×	○
Butadiene	C4H6	○	○	○
Cyclopentane	C5H10	○	○	○
Benzene	C6H6	○	○	×
N-hexane	n-C6H14	○	○	○
Toluene	C7H8	○	○	×
N-heptane	n-C7H16	○	○	○
Xylene	C8H10	○	○	×
N-nonane	n-C9H20	○	○	×
Ethyl acetate	EtAc	○	○	×
Isopropyl alcohol	IPA	○	○	×
Methyl ethyl ketone	MEK	○	○	×
Methyl methacrylate	MMA	○	○	×
Dimethyl ether	DME	○	○	×
Methyl isobutyl ketone	MIBK	○	○	×
Tetrahydrofuran	THF	○	○	×



CAUTION

- On models that detect combustible gases, the screen shown on the right may be displayed with the buzzer sounding and lamp flashing after the power is turned on or calibration is performed. If this screen is displayed, the conversion function cannot be used for gas types indicated by an “x” in the “Conversion when conversion is restricted” column. If the screen shown on the right appears, the alarm can be temporarily reset by pressing the **MODE** button, but the combustible gas sensor should be replaced with a new one promptly.

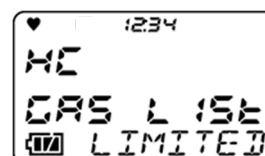

NOTE

- Combustible conversion gas selection is displayed for CH₄ and i-C₄H₁₀.
- This does not appear if “Display mode item display: ON/OFF” is disabled in user mode.
- To cancel before finalizing changes to the settings, hold down the **AIR** button and **MODE** button at the same time. The display returns to display mode.
- The alarm accuracy and alarm delay time shown in the specifications list apply only to the calibration gas.
- The concentration display when converted should be treated as approximate. To display accurate concentrations, you must perform calibration using the target gas. To perform span adjustment using the target gas, please contact Riken Keiki.
- For information on the list of gases that can be converted, see the “Combustible conversion gas list” on page 35.
- This product is supplied with several models depending on the combustible gas detected. Depending on the particular models, certain gas types may not be converted. See the “Combustible conversion gas list”.
- Even if a combustible conversion gas is selected, indications will be provided if other combustible gases are present in the usage environment.
- However, if hydrogen (H₂) is selected as a conversion gas, no indications will be issued, even if present in the usage environment for “Conversion when conversion is restricted” in the “Combustible conversion gas list”.
- If conversion is used, the indication accuracy for the product will not be achieved.

- 1 Press the **MODE** button on the measurement screen several times to display the LIST screen.**

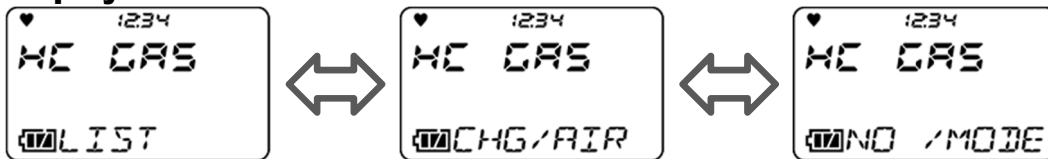

- 2 Press the **AIR** button several times to display the combustible gas you want to change.**

Pressing the **AIR** button toggles through the list of combustible gases.
The default setting is the calibration gas for the combustible gas sensor.

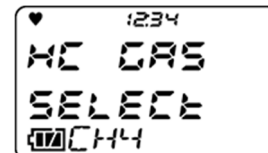

- 3 Press the **MODE** button when the combustible gas to be changed is displayed on the screen.**

“END” appears and the display returns to the screen in Step 1.

6-2-3. Long-life battery setting

This enables/disables the long-life battery setting. The default setting is “OFF”. When set to “ON”, the combustible gas concentration is refreshed every 15 seconds instead of every 5 seconds.

NOTE

- The setting is retained even when the power is turned off.
- This does not appear if “Display mode item display: ON/OFF” is disabled.
- If the long-life battery setting is enabled, no minus sensor alarm will be issued for the combustible gas sensor.
- The “L” lights up at the top of the screen when the long-life battery setting is enabled.

- 1 Press the **MODE** button on the measurement screen several times to display the LONG.BATT screen.**

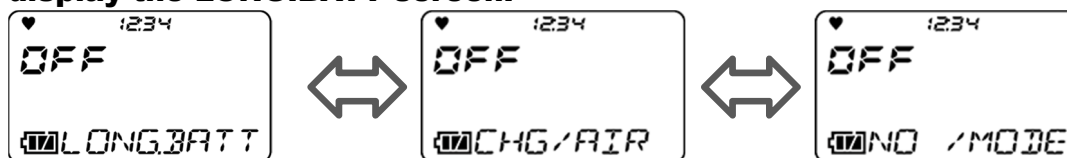

- 2 Press the **AIR** button to select “ON” or “OFF”.**

The default setting is “OFF”.

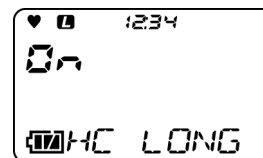

- 3 Press the **MODE** button.**

“END” appears and the display returns to the screen in Step 1.

6-2-4. Calibration data display

This displays the calibration date.

NOTE

- Calibration data is not displayed if the calibration expiration date setting is disabled in user mode. Calibration data is displayed only on general ATEX/IECEX specification.

- 1 Press the **MODE** button on the measurement screen several times to display the **CAL DATA** screen.

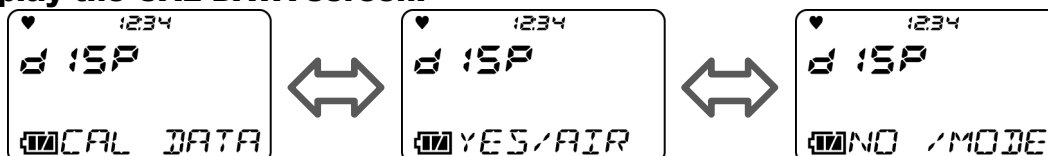

- 2 Press the **AIR** button to select “YES” or “NO”.

Pressing the AIR button cycles the display through “CH4” → “O2” → “H2S” → “CO” in sequence.

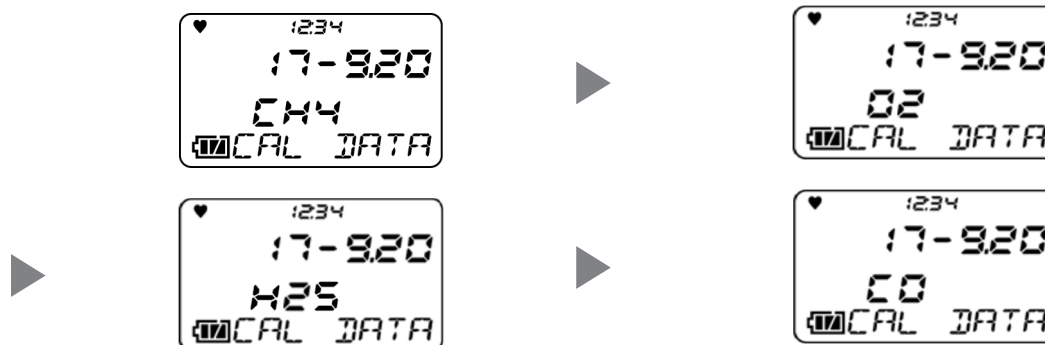

- 3 Press the **MODE** button.

“END” appears and the display returns to the screen in Step 1.

6-2-5. Bump data display

This displays the bump test date.

NOTE

- Bump data is not displayed if the bump test expiration date setting is disabled in user mode.
- After the gas calibration, the date is updated automatically.

- 1 Press the **MODE** button on the measurement screen several times to display the BUMP DATA screen.**

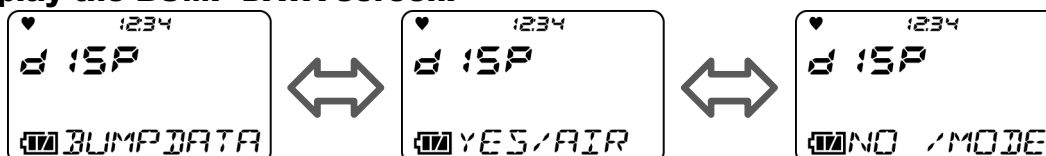

- 2 Press the **AIR** button to select “YES” or “NO”.**

Pressing the **AIR** button cycles the display through “CH4” → “O2” → “H2S” → “CO” → “CO2” → ...

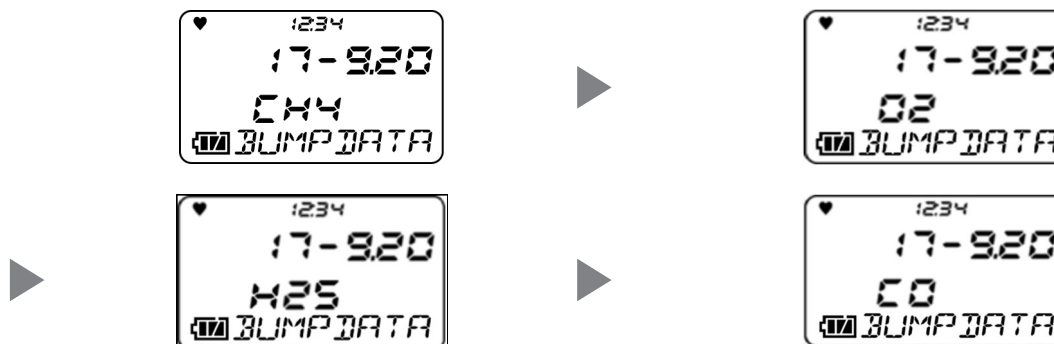

- 3 Press the **MODE** button.**

The display returns to the screen in Step 1.

6-2-5. Alarm setpoint display

This allows alarm setpoints to be displayed and testing of LED, buzzer, and vibrator operations.

NOTE

- TWA and STEL are displayed only on models that detect gases other than combustible gases and oxygen.

- 1 Press the **MODE** button on the measurement screen several times to display the **ALARM-PT** screen.

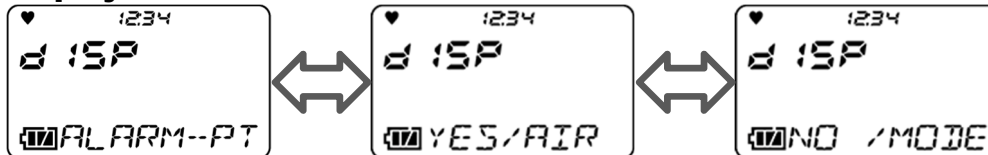

- 2 Press the **AIR** button.

Pressing the **AIR** button cycles the display through “F.S.” (FULL SCALE) → “WARNING” → “ALARM” → “ALARM H” → “STEL” → “TWA” → “F.S.” (FULL SCALE) → ...

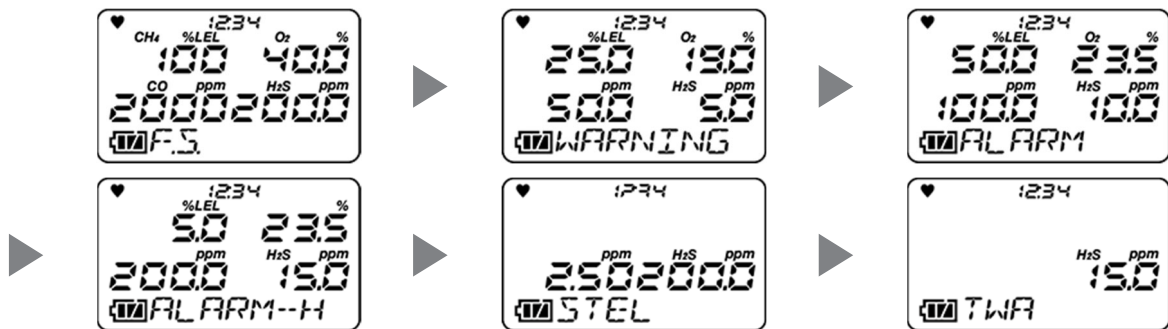

The corresponding alarm can be tested by pressing the **AIR** button and **MODE** button at the same time. Press any button to reset the alarm.

- 3 Press the **MODE** button.

The display returns to the screen in Step 1.

6-3. User mode

User mode lets you set the date and time, alarm setpoints, and other settings.

6-3-1. Displaying user mode

- 1 With the power turned off, press the **AIR** button and **POWER** button at the same time.**
- 2 Release the buttons when the buzzer blips.**
The power turns on, and the user mode menu appears.
- 3 Use the **AIR** button to select an item to be set, then using the **MODE** button, go to the setting screen.**
- 4 Once settings are complete, press the **AIR** button on the user mode menu several times to select “START”, then press the **MODE** button.**
The product operates in the same way as when the power has just been turned on and proceeds to the measurement screen.

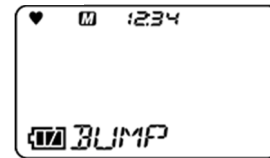
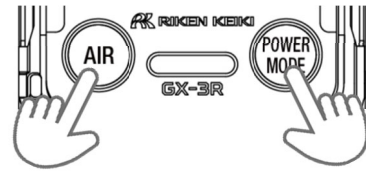



NOTE

- The display returns to the user mode menu after each setting. To return to the menu while configuring the settings, hold down the **AIR** button and **MODE** button at the same time.
- A password input screen is displayed if the password setting is enabled in user mode. For information on how to change the default password, see “6-4-12. User password setting” on page 59.

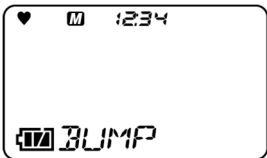
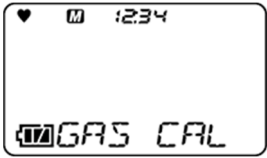
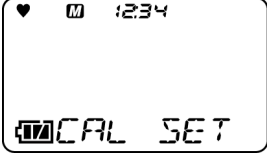
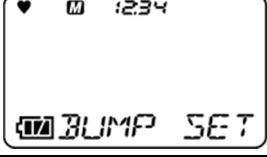
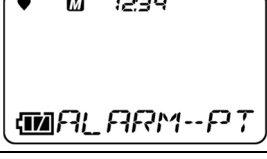
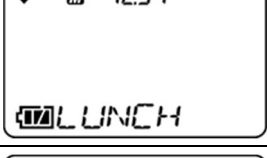
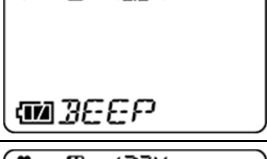
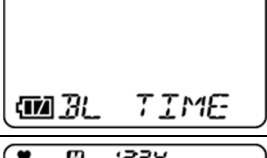
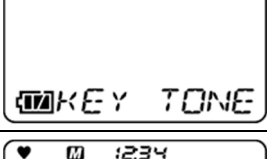
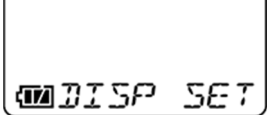
6-3-2. User mode settings

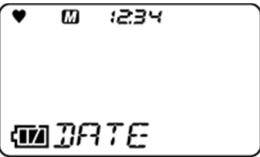
Screen display (setting item)	LCD display	Reference page
BUMP (Bump test)	 The LCD display shows a heart icon, a battery icon, and the number 1234 at the top. Below that, the word "BUMP" is displayed in a large, bold font.	P. 44
GAS CAL (Calibration)	 The LCD display shows a heart icon, a battery icon, and the number 1234 at the top. Below that, the words "GAS CAL" are displayed in a large, bold font.	P. 44
CAL SET (Calibration expiration date setting) * Displayed on general ATEX/IECEX specification only	 The LCD display shows a heart icon, a battery icon, and the number 1234 at the top. Below that, the words "CAL SET" are displayed in a large, bold font.	P. 44
BUMP SET (Bump test setting)	 The LCD display shows a heart icon, a battery icon, and the number 1234 at the top. Below that, the words "BUMP SET" are displayed in a large, bold font.	P. 47
ALARM-PT (Alarm setpoint setting)	 The LCD display shows a heart icon, a battery icon, and the number 1234 at the top. Below that, the words "ALARM-PT" are displayed in a large, bold font.	P. 52
LUNCH (Lunch break: ON/OFF)	 The LCD display shows a heart icon, a battery icon, and the number 1234 at the top. Below that, the word "LUNCH" is displayed in a large, bold font.	P. 54
BEEP (Confirmation beep setting)	 The LCD display shows a heart icon, a battery icon, and the number 1234 at the top. Below that, the word "BEEP" is displayed in a large, bold font.	P. 55
BL TIME (LCD lighting time setting)	 The LCD display shows a heart icon, a battery icon, and the number 1234 at the top. Below that, the words "BL TIME" are displayed in a large, bold font.	P. 57
KEY TONE (Key tone: ON/OFF)	 The LCD display shows a heart icon, a battery icon, and the number 1234 at the top. Below that, the words "KEY TONE" are displayed in a large, bold font.	P. 57
DISP SET (Display mode item display: ON/OFF)	 The LCD display shows a heart icon, a battery icon, and the number 1234 at the top. Below that, the words "DISP SET" are displayed in a large, bold font.	P. 58

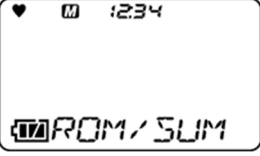
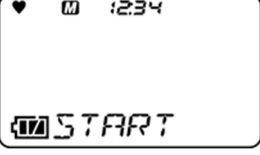
Screen display (setting item)	LCD display	Reference page
DATE (Date and time setting)	 <p>The LCD display shows a heart icon, a battery icon, and the number '1234' at the top. Below that, the word 'DATE' is displayed in a large, stylized font.</p>	P. 58
PASSWORD (Password setting)	 <p>The LCD display shows a heart icon, a battery icon, and the number '1234' at the top. Below that, the word 'PASSWORD' is displayed in a large, stylized font.</p>	P. 59
ROM/SUM (ROM/SUM display)	 <p>The LCD display shows a heart icon, a battery icon, and the number '1234' at the top. Below that, the text 'ROM/SUM' is displayed in a large, stylized font.</p>	P. 60
START (Measurement start)	 <p>The LCD display shows a heart icon, a battery icon, and the number '1234' at the top. Below that, the word 'START' is displayed in a large, stylized font.</p>	

6-4. User mode settings

User mode allows settings to be changed to increase usability.

6-4-1. Bump test

The product includes a function for performing a bump test (function check).

Here, you can select "Perform Bump Test (BUMP TEST)" and "Switch to measurement start screen from bump test (BUMP TEST)".

After the bump test is successful, the screen will automatically move to the measurement start screen.

*If multiple cylinder settings are selected, the measurement start screen will not move automatically after the success of bump test.

For information on the bump test procedure, see "7-3. Bump test" on page 72.

6-4-2. Calibration

The product's GAS CAL mode allows automatic calibration (AUTO CAL) using preset gas concentrations in addition to air calibration.

Span adjustment requires dedicated tools and a calibration gas. Contact Riken Keiki.

After successful gas calibration, the screen will automatically move to the measurement start screen.

*If multiple cylinder settings are selected, the measurement start screen will not move automatically after the success of bump test.

For information on the calibration procedure, see "7-2. Calibration" on page 63.

6-4-3. Calibration expiration date setting

This section describes "Calibration expiration date: ON/OFF", "Calibration expiration date interval", and "Operation after calibration date expired".

* Displayed on general ATEX/IECEX specification only

NOTE

- Once setting is complete, press the **AIR** button to select "ESCAPE", then press the **MODE** button. The display returns to the user mode menu.

<Calibration expiration date setting menu>

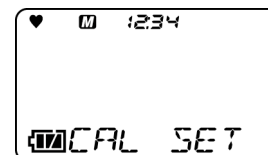

- 1 Press the **AIR** button on the user mode menu to select "CAL SET", then press the **MODE** button.**

The calibration expiration date setting menu screen is displayed.

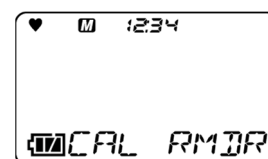

- 2 Press the **AIR** button to select the required setting, then press the **MODE** button.**

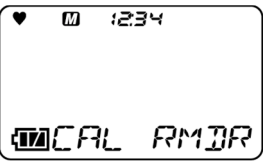
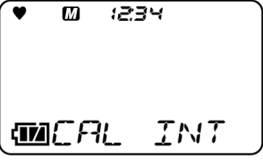

Setting item	LCD display	Reference page
CAL RMDR		<Calibration expiration date: ON/OFF> P. 45
CAL INT		<Calibration expiration date interval> P. 46
CAL EXPD		<Operation after calibration date expired> P. 46
ESCAPE		

<Calibration expiration date: ON/OFF>

This lets you enable and disable the calibration expiration date.

- 1 Press the **AIR** button to select “CAL RMDR”, then press the **MODE** button.**
The calibration expiration date ON/OFF selection is displayed.
- 2 Press the **AIR** button to select ON or OFF for the calibration expiration date setting, then press the **MODE** button.**
Pressing the **AIR** button toggles between ON and OFF for the calibration expiration date. The default setting is “ON”.
* General ATEX/IECEX specification only
- 3 Press the **MODE** button.**
“END” is displayed and the display returns to the calibration expiration date setting menu.

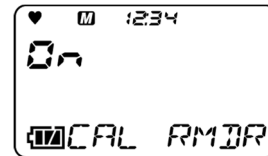
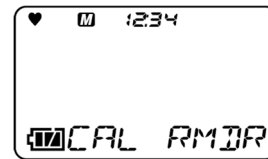

<Calibration expiration date interval>

This lets you select the number of days until the calibration expires.

- 1 Press the **AIR** button to select “CAL INT”, then press the **MODE** button.

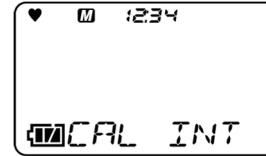

- 2 Press the **AIR** button to select the number of days for calibration expiration.

Pressing the **AIR** button lets you select the calibration expiration date interval between 1 and 1,000 days. The default setting is “90” days.

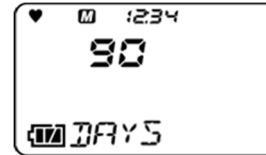

- 3 Press the **MODE** button.

“END” appears and the display returns to the calibration expiration date setting menu.

<Operation after calibration date expired>

This lets you specify the operation after the calibration date has expired.

- 1 Press the **AIR** button to select “CAL EXPD”, then press the **MODE** button.

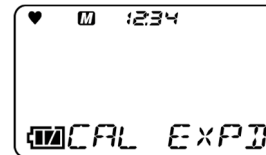

- 2 Press the **AIR** button to select the operation after the calibration date has expired.

Pressing the **AIR** button displays the following operations after calibration date expiration.

- CONFIRM: Action depends on the operation. Press the **AIR** button to proceed to measurement mode. Press the **MODE** button to proceed to Auto calibration cylinder setting.
- CANT USE: Measurement mode is not available. Press the **MODE** button or after 6 seconds without any operation to proceed to Auto calibration cylinder setting.
- NO EFFECT: Action depends on the operation. After the indication that calibration has expired, press the **MODE** button to proceed to Auto calibration cylinder setting. After 6 seconds without any operation, proceed to measurement mode automatically. The default setting is “CONFIRM”.

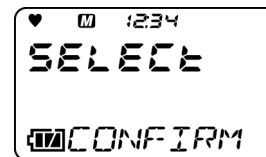

- 3 Press the **MODE** button.

“END” appears and the display returns to the calibration expiration date setting menu.

6-4-4. Bump test setting

This lets you set the various conditions for bump testing.

<Bump test setting menu>

- 1 Press the **AIR** button on the user mode menu to select “BUMP SET”, then press the **MODE** button.

The bump test menu screen is displayed.

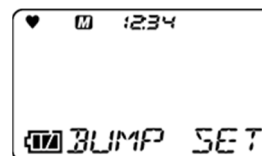

- 2 Press the **AIR** button to select the required setting, then press the **MODE** button.

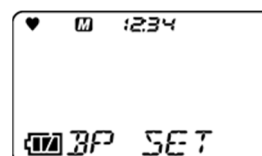

Setting item	LCD display	Reference page
SETTINGS		<Bump time selection> P. 48 <Bump tolerance selection> P. 49 <Calibration time selection after bump test> P. 49 <Calibration after bump test: ON/OFF> P. 50
BUMP.RMDR		<Bump test expiration date display: ON/OFF> P. 50
BUMP INT		<Bump expiration date interval selection> P. 51
BUMP.EXPD		<Operation setting after bump test expiration> P. 51
ESCAPE		

NOTE

- Once setting is complete, press the **AIR** button to select “ESCAPE”, then press the **MODE** button. The display returns to the user mode menu.

<Bump time selection>

This sets the time for introducing the test gas.

- 1 Press the **AIR** button to select “SETTINGS”, then press the **MODE** button.**

The bump test setting menu is displayed.

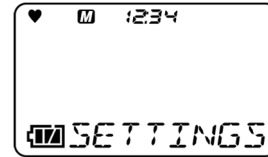

- 2 Press the **AIR** button to select “GAS TIME”, then press the **MODE** button.**

The bump time is displayed.

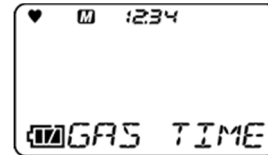

- 3 Press the **AIR** button to select the bump time, then press the **MODE** button.**

Pressing the **AIR** button lets you select the bump time from a choice of 30, 45, 60, and 90 seconds. The default setting is “30 SEC”.

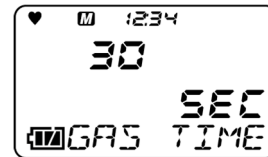

- 4 Press the **MODE** button.**

“END” appears and the display returns to the bump test setting menu.

<Bump tolerance selection>

This sets the threshold for checking the test gas.

Gases other than oxygen: Calibration concentration \pm (calibration concentration \times tolerance)

Oxygen: Calibration concentration \pm (difference between calibration concentration and 20.9% \times tolerance)

- 1 **Press the AIR button to select “SETTINGS”, then press the MODE button.**

The bump test setting menu is displayed.

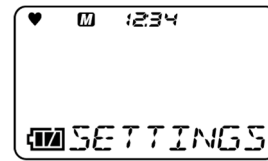

- 2 **Press the AIR button to select “CHECK”, then press the MODE button.**

The bump tolerance is displayed.

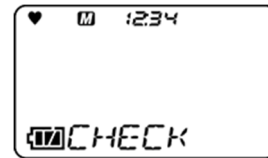

- 3 **Press the AIR button to select the bump tolerance, then press the MODE button.**

Pressing the AIR button lets you select the bump tolerance from a choice of 10, 20, 30, 40, and 50 %. The default setting is “50” %.



- 4 **Press the MODE button.**

“END” appears and the display returns to the bump test setting menu.

<Calibration time selection after bump test

This selects the time for calibration after a bump test has failed.

- 1 **Press the AIR button to select “SETTINGS”, then press the MODE button.**

The bump test setting menu is displayed.

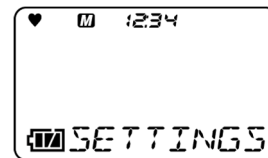

- 2 **Press the AIR button to select “CAL TIME”, then press the MODE button.**

The time for calibration after a bump test is displayed.

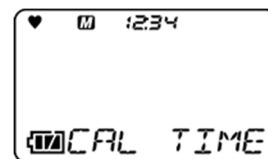

- 3 **Press the AIR button to select the calibration time after a bump test, then press the MODE button.**

Pressing the AIR button lets you select the calibration time after a bump test from a choice of 90 and 120 seconds. The default setting is “90 SEC”.

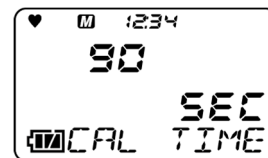

- 4 **Press the MODE button.**

“END” appears and the display returns to the bump test setting menu.

<Calibration after bump test: ON/OFF>

This enables/disables the function for automatic calibration if a bump test fails.

- 1 Press the AIR button to select “SETTINGS”, then press the MODE button.**

The bump test setting menu is displayed.

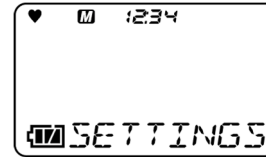

- 2 Press the AIR button to select “AUTO CAL”, then press the MODE button.**

The ON/OFF selection is displayed for calibration after a bump test fails.

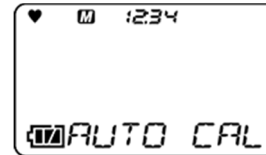

- 3 Press the AIR button to select ON or OFF for calibration after a bump test fails, then press the MODE button.**

Pressing the AIR button lets you select ON or OFF for calibration after a bump test fails. The default setting is “ON”.

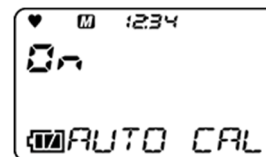

- 4 Press the MODE button.**

“END” appears and the display returns to the bump test setting menu.

<Bump test expiration date display: ON/OFF>

This selects the notification for bump test expiration.

- 1 Press the AIR button to select “BUMP.RMDR”, then press the MODE button.**

The ON/OFF selection is displayed for bump test expiration date notification.

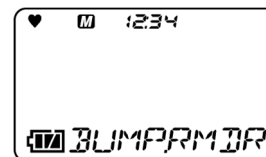

- 2 Press the AIR button to select ON or OFF for the bump test expiration date display.**

Pressing the AIR button lets you select ON or OFF for the bump test expiration date display. The default setting is “OFF”.

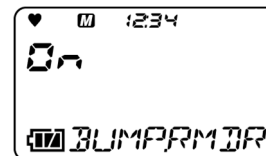

- 3 Press the MODE button.**

“END” appears and the display returns to the bump test setting menu.

<Bump expiration date interval selection>

This sets the interval until the bump test expiration date notification is given after a bump test.

- 1 Press the **AIR** button to select “BUMP INT”, then press the **MODE** button.**

You can select the number of days until the bump test expiration date.

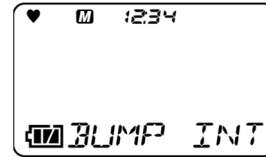

- 2 Press the **AIR** button to select the bump test expiration date interval.**

Pressing the **AIR** button lets you select the bump test expiration date interval from 0 to 30 days. The default setting is “30” days.

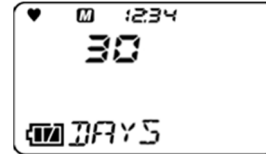

- 3 Press the **MODE** button.**

“END” appears and the display returns to the bump test setting menu.

<Operation setting after bump test expiration>

This selects the operation after the bump test expiration date display.

- 1 Press the **AIR** button to select “BUMP.EXPD”, then press the **MODE** button.**

You can select the operation after bump test expiration.

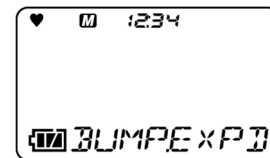

- 2 Press the **AIR** button to select the operation after bump test expiration operation confirmation.**

Pressing the **AIR** button displays the following operations after bump test expiration:

Pressing the **AIR** button displays the following operations after calibration date expiration.

- CONFIRM: Action depends on the operation.
Press the **AIR** button to proceed to measurement mode. Press the **MODE** button to proceed to Bump test cylinder setting.
- CANT USE: Measurement mode is not available.
Press the **MODE** button or after 6 seconds without any operation to proceed to Bump test cylinder setting.
- NO EFFECT: Action depends on the operation.
After the indication that calibration has expired, press the **MODE** button to proceed to Bump test cylinder setting. After 6 seconds without any operation, proceed to measurement mode automatically.

The default setting is “CONFIRM”.

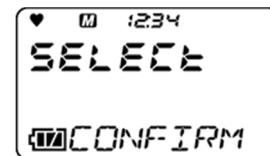

- 3 Press the **MODE** button.**

“END” appears and the display returns to the bump test setting menu.

6-4-5. Alarm setpoint setting

This section describes the settings for the first to third alarm setpoints, STEL alarm setpoint, and TWA alarm setpoint and how to restore the default settings.

<Alarm setpoint setting>

Alarm setpoints can be set using one-digit units.

Detection target gas	1 digit	Lower limit	Upper limit
Combustible gas (HC/CH ₄)	1 %LEL	5 %LEL	60 %LEL
Carbon monoxide (CO)	1 ppm	15 ppm	2,000 ppm
Hydrogen sulfide (H ₂ S)	0.1 ppm	1.0 ppm	200.0 ppm

Detection target gas	1 digit	First/second alarm		Third alarm	
		Lower limit	Upper limit	Lower limit	Upper limit
Oxygen (O ₂)	0.1 vol%	0.0 %	20.0 %	21.8 %	40.0 %

NOTE

- Set the alarm setpoints as follows: First alarm ≤ second alarm ≤ third alarm (first alarm ≥ second alarm for oxygen)

- 1 Press the **AIR** button on the user mode menu to select “ALARM-PT”, then press the **MODE** button.

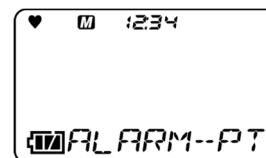

- 2 Press the **AIR** button to select the gas type, then press the **MODE** button.

Pressing the **AIR** button alternately displays the detection target gas and the alarm setpoint reset screen (page 53).

Pressing the **MODE** button displays the first alarm setpoint (WARNING) setting screen.

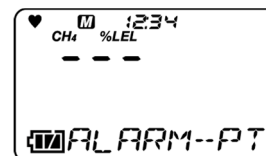

- 3 Press the **AIR** button to select a numerical value for the first alarm setpoint, then press the **MODE** button.

The second alarm setpoint (ALARM) setting screen is displayed.

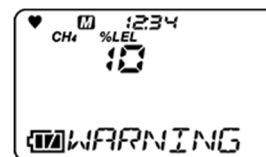

- 4 Press the **AIR** button to select the second alarm setpoint numerical value, then press the **MODE** button.

The third alarm setpoint (ALARM H) setting screen is displayed.

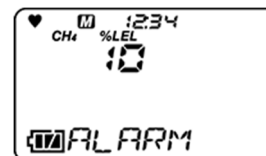

- 5 Press the **AIR** button to select the third alarm setpoint numerical value, then press the **MODE** button.

For toxic gas, the STEL and TWA setting screens are displayed after the above steps. Set these in the same way.

“END” appears and the alarm setpoint reset screen appears.

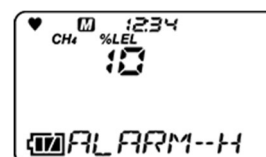

NOTE

- For information on how to reset settings, see “Resetting alarm setpoints” on page 53. The alarm setpoint reset screen may not appear if the product is not set correctly. If this occurs, contact Riken Keiki.
- For more information on alarm setpoints, see “4 Alarm Activation” on page 18.

<Resetting alarm setpoints>

This restores alarm setpoints to their default settings.

- 1 Press the AIR button on the user mode menu to select “ALARM-PT”, then press the MODE button.**

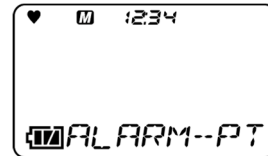

- 2 Press the AIR button several times.**

The alarm setpoint reset screen is displayed.

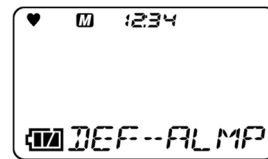

- 3 Press the MODE button.**

The alarm setpoint reset confirmation screen is displayed.

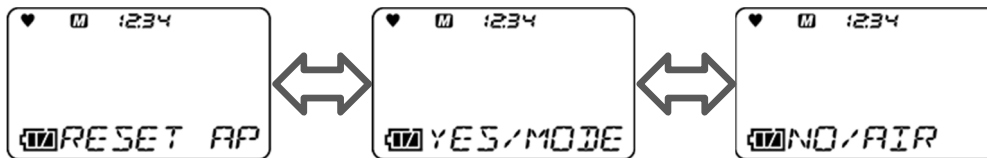

To cancel resetting, press the AIR button.

- 4 Press the MODE button.**

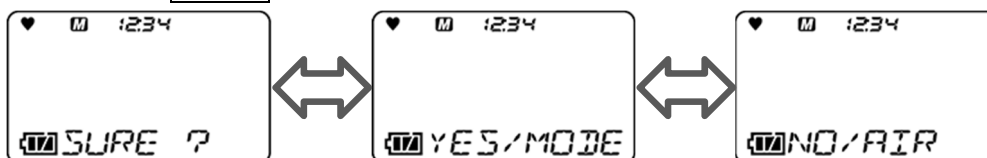

The alarm setpoint reset confirmation screen is displayed.

- 5 Press the MODE button.**

“END” appears and the display returns to the user mode menu.

6-4-6. Lunch break: ON/OFF

This lets you enable and disable the lunch break function. The lunch break function retains TWA and PEAK values from the last time the power was turned off and loads them to continue measurement the next time the power is turned on.

- 1 Press the **AIR** button on the user mode menu to select “LUNCH”, then press the **MODE** button.**

The lunch break setting screen is displayed.

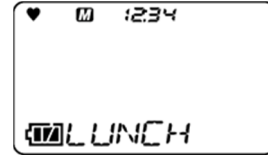

- 2 Press the **AIR** button to select ON or OFF for the lunch break function.**

Pressing the **AIR** button lets you select ON or OFF for the lunch break function. The default setting is “OFF”.

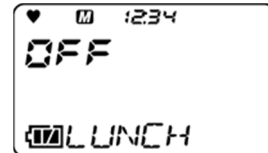

- 3 Press the **MODE** button.**

“END” appears and the display returns to the user mode menu.

NOTE

- When the lunch break setting is enabled, a confirmation screen is displayed asking the user whether to retain the TWA and PEAK values from the last time the power was turned off and continue measurement or to reset the values when the power is turned on.

6-4-7. Confirmation beep setting

This function provides an audible indication of whether the product is operating normally. The buzzer sounds at preset intervals while measurement is underway. The following functions can also be operated with "BUMP / CAL", "ALM ALRT" and "B / C / ALM".

1. BUMP/CAL
 - Starts operation when calibration deadline setting is ON and or calibration is expired, or bump deadline setting is ON and bump is expired.
 - Once the operation is starts, it does not stop until all loaded gases are calibrated or bumped. (Except H2 cancellation)
 - Every interval setting time The LED lights up for about one second.
2. ALM ALRT
 - Starts operation when a gas alarm is issued. (Including minus sensor failure)
 - Once the operation is starts, it does not stop until all loaded gases are calibrated or bumped. (Except H2 cancellation)
 - Every interval setting time The LED lights up for about one second.
3. B/C/ALM
 - Starts operation when calibration deadline setting is ON and or calibration is expired, or bump deadline setting is ON and bump is expired.
 - Once the operation is starts, it does not stop until all loaded gases are calibrated or bumped. (Except H2 cancellation)
 - Every interval setting time The LED lights up for about one second.

<Confirmation beep setting menu>

- 1 **Press the AIR button on the user mode menu to select "BEEP", then press the MODE button.**

The confirmation beep menu screen is displayed.

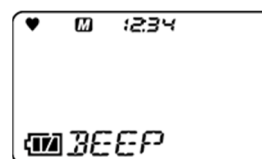

- 2 **Press the AIR button to select the required setting, then press the MODE button.**

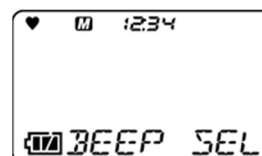

Setting item	LCD display	Reference page
BEEP SEL		<Beep operation setting> P. 53
BEEP INT		<Beep interval setting> P. 53
ESCAPE		

NOTE

- Once setting is complete, press the **AIR** button to select “ESCAPE”, then press the **MODE** button. The display returns to the user mode menu.

<Beep operation setting>

This lets you set the confirmation beep operation.

1 Press the **AIR button to select “BEEP SEL”, then press the **MODE** button.**

The beep operation selection screen is displayed. However, if you change the setting, the operations of “BUMP / CAL”, “ALM ALRT” and “B / C / ALM” will stop.

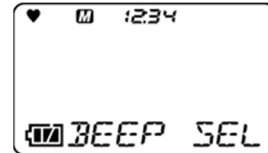

2 Press the **AIR button.**

Pressing the **AIR** button displays the following screens in sequence:

- OFF
- LED (LED lights only)
- BUZZER (buzzer only)
- LED+BUZZ (LED and buzzer)
- BUMP/CAL
- ALARM ALRT
- B/C/ALM

The default setting is “OFF”.



3 Press the **MODE button.**

“END” appears and the display returns to the confirmation beep setting menu.

<Beep interval setting>

This lets you set the interval between confirmation beeps.

1 Press the **AIR button to select “BEEP INT”, then press the **MODE** button.**

The beep interval setting screen is displayed.

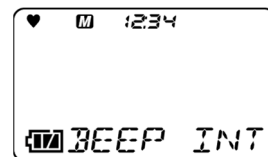

2 Press the **AIR button.**

Pressing the **AIR** button lets you select the beep interval from a choice of 0.5 minutes and from 1 to 99 minutes. The default setting is “5” minutes.

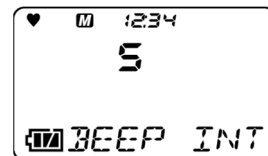

3 Press the **MODE button.**

“END” appears and the display returns to the confirmation beep setting menu.

6-4-8. LCD lighting time setting

This lets you set the duration for which the LCD display remains lit.

- 1 Press the **AIR** button on the user mode menu to select “BL TIME”, then press the **MODE** button.**

The backlight lighting time setting screen is displayed.

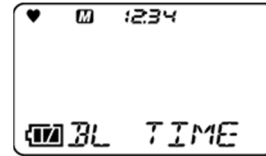

- 2 Press the **AIR** button to select the backlight lighting time.**

Pressing the **AIR** button lets you select a backlight lighting time of OFF or 1 to 255 seconds. The default setting is “30 SEC”.

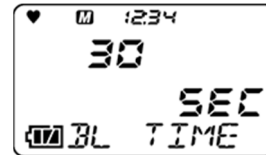

- 3 Press the **MODE** button.**

“END” appears and the display returns to the user mode menu.

6-4-9. Key tone: ON/OFF

This enables/disables the key operation tone.

- 1 Press the **AIR** button on the user mode menu to select “KEY TONE”, then press the **MODE** button.**

The key tone setting screen is displayed.

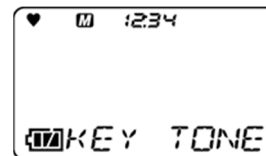

- 2 Press the **AIR** button to select ON or OFF for the key tone.**

Pressing the **AIR** button lets you select ON or OFF for the key tone. The default setting is “ON”.

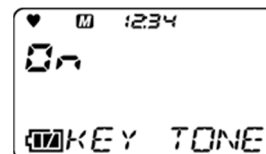

- 3 Press the **MODE** button.**

“END” appears and the display returns to the user mode menu.

6-4-10. Display mode item display: ON/OFF

This lets you set whether display mode items that can be set are displayed or hidden. When set to OFF, items such as "HC GAS" (combustible conversion gas selection) are not displayed in display mode.

- 1 Press the **AIR** button on the user mode menu to select "DISP SET", then press the **MODE** button.**

The display mode item display setting screen is displayed.

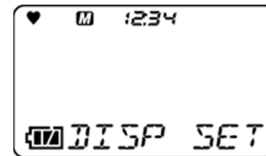

- 2 Press the **AIR** button to select ON or OFF for the display mode item display.**

Pressing the **AIR** button lets you select ON or OFF for the display mode item display. The default setting is "ON".

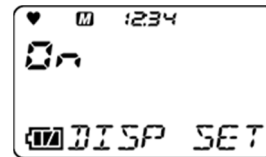

- 3 Press the **MODE** button.**

"END" appears and the display returns to the user mode menu.

6-4-11. Date and time setting

This sets the date and time of the internal clock

- 1 Press the **AIR** button on the user mode menu to select "DATE", then press the **MODE** button.**

The date and time setting screen is displayed. The item currently blinking can be set.

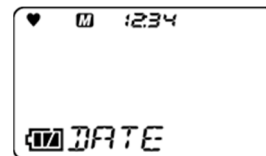

- 2 Press the **AIR** button to select the required setting item, then press the **MODE** button.**

Set the date and time in the sequence year -> month -> day -> hour -> minute.

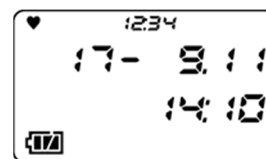

Press the **MODE** button after setting the "minute" item. "END" appears and the display returns to the user mode menu.

6-4-12. User password setting

This lets you protect access to user mode using a password. The password can be set as a four-digit number in the range 0000 to 9999.

- 1 Press the **AIR** button on the user mode menu to select “PASSWORD”, then press the **MODE** button.**

The password can be enabled or disabled on the user mode password setting screen.

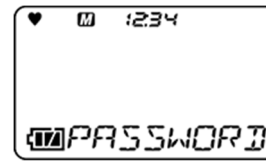

- 2 Press the **AIR** button to select “ON”, then press the **MODE** button.**

The password input screen is displayed. The default setting is “0000”.

The password can be set as a four-digit number in the range 0000 to 9999.

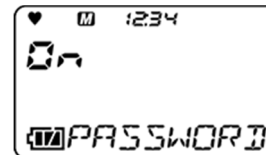

- 3 Press the **AIR** button to select a number from 0 to 9, then press the **MODE** button.**

The number is input as the first digit of the password and the second digit blinks.

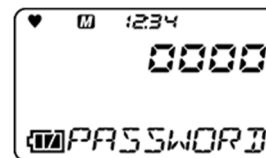

Press the **MODE** button after entering the final digit. “END” appears and the display returns to the user mode menu.

<Accessing user mode when password-protected>

- 1 With the power turned off, press the **AIR** button and **POWER** button at the same time.**

Release the buttons when the buzzer blips. The password input screen is displayed.

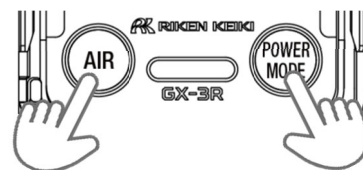

- 2 Enter the preset password.**

Press the **AIR** button to select the number for the currently selected digit, then press the **MODE** button to confirm.

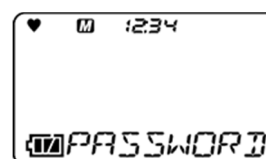
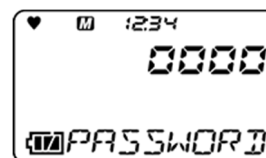

The user mode menu is displayed once the password has been correctly entered. If the password entered is incorrect, an error is displayed. The display switches to “Screen transition from powering on to displaying measurement screen” in “5-3. Startup”.

6-4-13. ROM/SUM display

This displays the program number and SUM value of the product.

* This is not normally used by the user.

- 1 Press the **AIR** button on the user mode menu to select “ROM/SUM”, then press the **MODE** button.**

The ROM/SUM screen is displayed.

The following information is displayed alternately on the ROM/SUM screen.

- MAIN ROM
- SENS. ROM

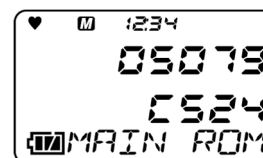
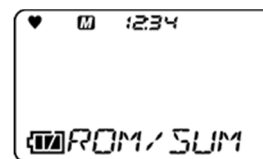

- 2 Press the **MODE** button.**

“END” appears and the display returns to the user mode menu.

7

Maintenance

The product is an important safety and disaster-prevention device. Maintain the product at regular intervals to ensure performance and improve disaster-prevention and safety reliability.

7-1. Maintenance intervals and maintenance items

The following items should be maintained regularly before using the product:

- Daily maintenance: Perform maintenance before commencing work.
- Monthly maintenance: Perform maintenance by testing the alarms once a month.
- Regular maintenance: Perform maintenance at least once a year (ideally, at least once every six months).

Maintenance item	Maintenance details	Daily maintenance	Monthly maintenance	Regular maintenance
Battery level	Check to confirm that battery levels are adequate.	○	○	○
Concentration display	Check to confirm that the concentration readout is 0 (or 20.9 % for oxygen meter) by measuring fresh air. If the readout is not 0, check to confirm that no interference gases are present, then perform air calibration.	○	○	○
Main unit operation	Check the LCD display to confirm that the readout is not faulty.	○	○	○
Filter	Check to confirm that the filter is not dirty.	○	○	○
Alarm test	Test the alarm and check to confirm that the alarm LED arrays, buzzer, and vibrator all operate correctly.	-	○	○
Span adjustment	Perform span adjustment using a calibration gas.	-	-	○
Gas alarm check	Check the gas alarm with a calibration gas.	-	-	○



WARNING

- If an abnormality is discovered in the product, contact Riken Keiki immediately.

NOTE

- Span adjustment requires dedicated tools and preparation of a calibration gas. Always contact Riken Keiki for span adjustment.
- The built-in sensors have finite service lives and must be replaced regularly.
- If the sensors cannot be calibrated using span adjustment, the readings are not restored after air calibration, or the readings fluctuate, the sensors are at the end of their life. Contact Riken Keiki for replacement.

Maintenance service

Riken Keiki provides services related to regular maintenance including span adjustment, as well as other adjustments and maintenance.

Preparing calibration gas requires the use of dedicated tools, such as gas cylinders of the specified concentration and gas sampling bags.

Our certified service engineers have expert knowledge of the dedicated tools used for these services, along with expertise in products. Please take advantage of the Riken Keiki maintenance service to maintain safe operation of the product.

The maintenance service includes the following main aspects. Please contact Riken Keiki for more information.

<Main maintenance service details>

Battery level check	Checks battery levels.
Concentration display check	Checks to confirm that the concentration readout is 0 (or 20.9 % for oxygen meter) using a zero gas. Zero calibration (zero adjustment) is performed if the reading is not zero.
Filter check	Checks the dust filter for contamination and clogging. The filter is replaced if dirty or clogged.
Alarm test	Tests the alarm to check to confirm that the alarm LEDs, buzzer, and vibrator all operate correctly.
Span adjustment	Performs span adjustment using a calibration gas.
Gas alarm check	Checks the gas alarm using a calibration gas. <ul style="list-style-type: none"> • Checking alarms (confirming alarm activation when alarm setpoint is reached) • Checking delay time (checking delay time until alarm activation) • Checks the buzzer, LEDs, vibrator, and concentration display. (Checks operation for each of the three-step alarms.)
Product cleaning and repair (visual inspection)	Checks the exterior of the product for dirt and damage; cleans and repairs any prominent problem areas. Parts are replaced if cracked or damaged.
Product operation check	Operates the buttons to check function operations and parameters.
Consumable part replacement	Replaces degraded components such as sensors and filters.

7-2. Calibration

The product can be calibrated using automatic calibration with preset gas concentrations in addition to air calibration.

Span adjustment requires dedicated tools and a calibration gas. Contact Riken Keiki.



CAUTION

- Do not use lighter gas to check the sensitivity of the product. Constituents in the lighter gas may degrade sensor performance.

7-2-1. Preparation for calibration

This section describes how to calibrate the product using calibration adapter (simple type).

<Required equipment/materials>

- Calibration gas
- Gas sampling bag
- Calibration adapter (simple type) *ATEX/IECEX specification is shipped with this parts.
- Pump

<Recommended calibration gas concentrations>

Detection target gas	Sensor model	Calibration gas	Calibration gas concentration
Combustible gas (HC)	NCR-6309	Isobutane (i-C ₄ H ₁₀)	50%LEL (0.7 vol%)
Combustible gas (CH ₄)	NCR-6309	Methane (CH ₄)	50%LEL (2.2 vol%)
Hydrogen sulfide (H ₂ S)	ESR-A1DP or ESR-A13i	Hydrogen sulfide (H ₂ S)	25.0 ppm
Oxygen (O ₂)	ESR-X13P	Oxygen (O ₂) Nitrogen diluted	12.0 %
Carbon monoxide (CO)	ESR-A1DP, ESR-A1CP, or ESR-A13P	Carbon monoxide (CO)	50 ppm
Carbon monoxide (CO)	ESR-A1CP	Hydrogen (H ₂) air diluted	500 ppm

* Hydrogen must be calibrated in the range 10 °C to 30 °C.

* The same applies to bump test gas.

<Gas supply method>

Attach a calibration adapter (simple type) to the product, connect the gas sampling bag as shown in the figure below to introduce gas at a flow rate of 250 mL/min, and wait 60 seconds after the reading increases before calibrating.

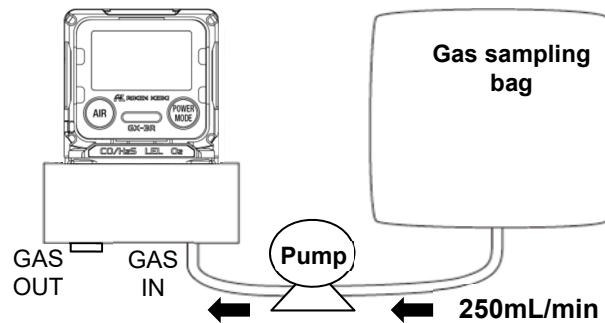

WARNING

Calibration gas

The calibration gas is a hazardous gas (e.g., combustible gas, toxic gas, oxygen deficiency). Handle the gas and related jigs and tools with due care.

Gas sampling bag

Use different gas sampling bags for each gas type and concentration to ensure accurate calibration.

Calibration location

- Do not calibrate in a confined space.
- Do not calibrate in locations where gases such as silicone and spray can gases are used.
- Calibrate indoors at normal temperatures with no significant fluctuations (within ± 5 °C).

Carbon monoxide sensor (ESR-A1CP) calibration

- The carbon monoxide sensor with hydrogen interference correction function (ESR-A1CP) must be calibrated separately for carbon monoxide and hydrogen.
- The carbon monoxide and hydrogen used for calibration must each be a single gas. Calibration can be performed using a gas mixture, but correct span adjustment will not be achieved, and concentration readings will be inaccurate.
- If hydrogen sensitivity is not calibrated, carbon monoxide readings may be slightly higher or lower than the actual concentrations when measured in environments where hydrogen is also



CAUTION

- When supplying gas, leave the GAS OUT side open and discharge the supplied gas to a safe place, or connect the gas sampling bag to the GAS OUT side to recover the supplied gas.
- If it is used and stored for a long time in a dry environment, the hydrogen gas sensitivity calibration may not be possible. If FAIL SENSOR is displayed at the time of hydrogen gas sensitivity calibration, release the main body overnight or more in an environment with sufficient humidity. Please install again and perform gas calibration again. However, if CO gas sensitivity calibration can not be performed, please contact your dealer or our nearest sales office for sensor replacement.

NOTE

- RP-3R (option) or SDM-3R (option) can also be used for calibration in addition to the methods described above.
To use RP-3R (option), the pump mode should be set to Low mode.

7-2-2. Calibration setting menu

This section describes “Air calibration”, “Auto calibration concentration setting”, “Auto calibration cylinder setting”, “Auto calibration”, and “CO₂ zero calibration”.

- 1 Press the **AIR** button on the user mode menu to select “GAS CAL”, then press the **MODE** button.

The calibration menu screen is displayed.

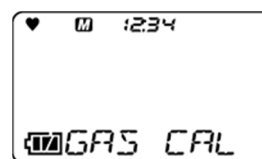

- 2 Press the **AIR** button to select the required setting, then press the **MODE** button.

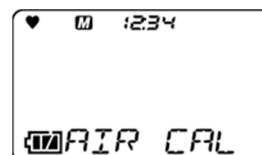

Setting item	LCD display	Reference page
AIR CAL		“7-2-3. Air calibration” (P. 66)
AUTO CAL		“7-2-4. Auto calibration” (P. 67) “7-2-6. Auto calibration cylinder setting” (P. 70) “ 7-2-7. Auto calibration gas concentration selection” (P. 71)
ESCAPE		

NOTE

- Once setting is complete, press the **AIR** button to select “ESCAPE”, then press the **MODE** button. The display returns to the user mode menu.

7-2-3. Air calibration



WARNING

- When air calibration is performed in the atmosphere, check the atmosphere for freshness before starting. The presence of interference gases will make it impossible to perform zero adjustment correctly and potentially result in hazardous conditions in the event of actual gas leaks.



CAUTION

- Always perform air calibration under conditions of pressure, temperature, and humidity similar to those in the operating environment and in fresh air.
- Wait for the readout to stabilize before performing air calibration.

- 1 Press the **AIR** button to select “AIR CAL”, then press the **MODE** button.**

The air calibration screen is displayed.

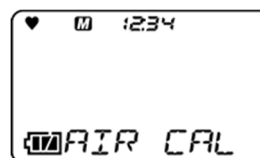

- 2 Hold down the **AIR** button.**

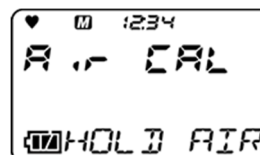
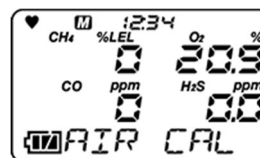

- 3 Release the button when “RELEASE” is displayed.**

Air calibration is performed.

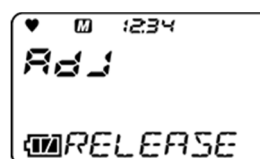

“PASS” is displayed if air calibration was successful.



The current concentration after air calibration appears. The display returns to the calibration menu screen.

“FAIL” is displayed if calibration was unsuccessful.

“END” appears and the display returns to the calibration menu screen.

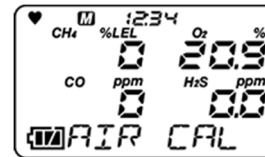

NOTE

- If air calibration fails, “FAIL” appears next to the measurement for the faulty sensor together with “AIR CAL”. Press the **MODE** button to reset the fault alarm (calibration failure). Air calibration will not be performed for the faulty sensor and the concentration will be calculated using the value before calibration.
- Air calibration can also be performed in measurement mode. (P. 27)

7-2-4. Auto calibration

This calibrates for each gas at the specified concentration.

- 1 Press the **AIR** button to select “**AUTO CAL**”, then press the **MODE** button.

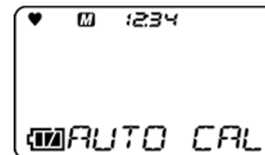

- 2 Select the cylinder for calibration, then press the **MODE** button.

For information on cylinder settings, see “7-2-6. Auto calibration cylinder setting” on page 70.

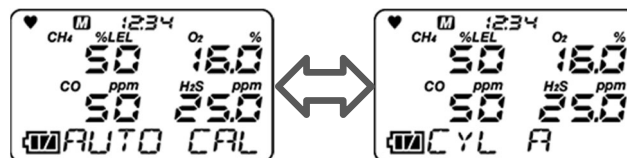

- 3 Introduce the calibration gas, wait 60 seconds, and then press the **MODE** button.

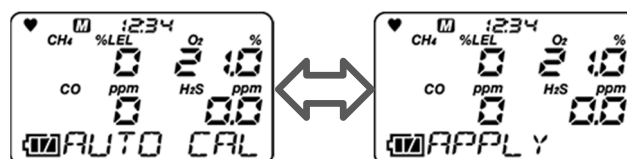

Auto calibration is performed.

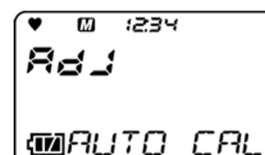

“PASS” is displayed if auto calibration was successful.
 “FAIL” is displayed if calibration was unsuccessful.



The concentration after auto calibration is displayed.

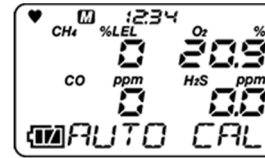

Moves to the measurement start screen.



CAUTION

- Air calibration must always be performed before auto calibration.
- For models with a combustible gas sensor installed, the screen shown on the right may be displayed after auto calibration. If this screen is displayed, some combustible gases cannot be converted using the combustible gas conversion function. For information on the types of gases that cannot be converted, see “6-2-2. Combustible conversion gas selection” on page 35. If the screen shown on the right appears, replace the combustible gas sensor with a new one promptly.

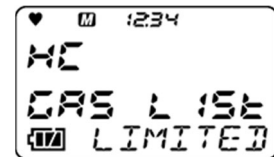

NOTE

- Air calibration must always be performed before auto calibration.

7-2-5. Switch from AUTO calibration to measurement start screen

In this section, it explains about switchment from AUTO calibration to measurement start screen.

- 1 Press the **AIR** button and select “**AUTO CAL**” and press the **MODE** button.
AUTO calibration screen is displayed.

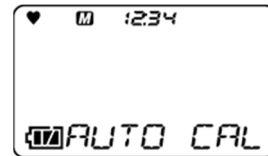

- 2 Press the **AIR** button and select “**START**”, then press the **MODE** button.



The LCD lights up completely and will move to the measurement start screen.



7-2-6. Auto calibration cylinder setting

This section describes how to set gas groups (cylinders) for calibration. Five cylinders can be set as A to E.

- 1 Press the **AIR** button to select “AUTO CAL”, then press the **MODE** button.**

The auto calibration screen is displayed.

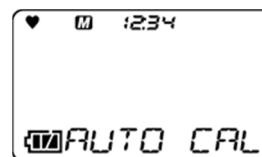

- 2 Press the **AIR** button and select “CYL SEL”, then press the **MODE** button.**

Pressing the **AIR** button displays the gas type and concentration for cylinders A to E in sequence.

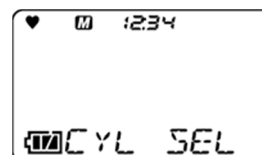

- 3 Press the **AIR** button.**

Pressing the **AIR** button displays the detection target gas in sequence.

Pressing the **AIR** button once more displays “ESCAPE” and returns the display to the screen in Step 1.

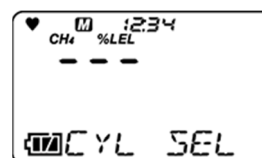

- 4 Press the **MODE** button on the sensor selection screen for changing cylinder settings.**

- 5 Press the **AIR** button to select a cylinder from A to E, then press the **MODE** button.**

“END” appears and the display returns to the screen shown in the step 3 returns automatically..

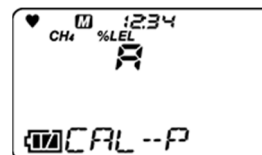

7-2-7. Auto calibration gas concentration selection

This section describes how to select the calibration gas concentration for the individual sensors. Calibration gas concentration can be set in one-digit units within the setting range.

<Calibration gas concentration setting range>

Detection target gas	Sensor model	Calibration gas	1 digit	Lower limit	Upper limit
Combustible gas (HC)	NCR-6309	Isobutane (i-C ₄ H ₁₀)	1 %LEL	5 %LEL	75 %LEL
Combustible gas (CH ₄)	NCR-6309	Methane (CH ₄)	1 %LEL	5 %LEL	75 %LEL
Hydrogen sulfide (H ₂ S)	ESR-A1DP or ESR-A13i	Hydrogen sulfide (H ₂ S)	0.1 ppm	1.0 ppm	200.0 ppm
Oxygen (O ₂)	ESR-X13P	Oxygen (O ₂)	0.1 vol%	0.0 vol%	18.0 vol%
Carbon monoxide (CO)	ESR-A1DP, ESR-A1CP, or ESR-A13P	Carbon monoxide (CO)	1 ppm	15 ppm	2,000 ppm
Carbon monoxide (CO)	ESR-A1CP	Hydrogen (H ₂)	1 ppm	25 ppm	2,000 ppm

* CO-(H₂) calibration should be performed using single gas and not as a mixture of CO and H₂.

* Hydrogen must be calibrated in the range from 10 °C to 30 °C.

- 1 Press the **AIR** button to select “**AUTO CAL**”, then press the **MODE** button.

The auto calibration screen is displayed.

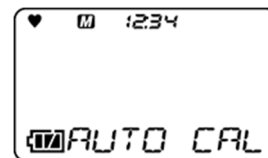

- 2 Press the **AIR** button to select “**CAL-P**”, then press the **MODE** button.

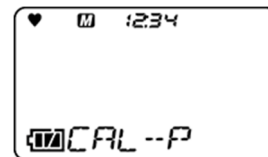

- 3 Press the **AIR** button to select the calibration gas type.

Pressing the **AIR** button displays the detection target gas in sequence.

Pressing the **AIR** button once more displays “**ESCAPE**” and returns the display to the screen in Step 1.

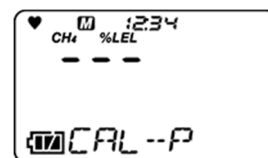

- 4 Press the **MODE** button on the sensor selection screen for changing calibration gas concentrations.

The calibration concentration change screen is displayed.

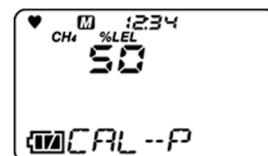

- 5 Press the **AIR** button to select the calibration concentration, then press the **MODE** button.

“END” appears and the display returns to the screen shown in the step 3 returns automatically..

7-3. Bump test

The product includes a function for performing a bump test (function check).

7-3-1. Perform bump test (BUMP TEST)

A bump test can be performed for gas types selected from cylinders A to E. Prepare a bump test gas in the same way as for the calibration gas (P. 63).

- 1 Press the **AIR** button on the user mode menu to select “BUMP”, then press the **MODE** button.

The bump test screen is displayed.

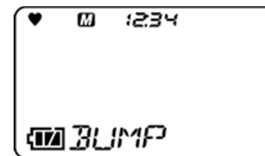

- 2 Press the **AIR** button to select the cylinder for the bump test, then press the **MODE** button.

Introduce the gas for the bump test.
The bump test is performed.

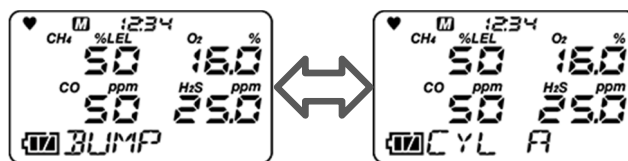

If calibration is specified to be performed after a bump test fails, calibration will be automatically performed if the bump test fails.

After the bump test and calibration are completed, the bump test results (left), calibration results (right) are displayed together with the readings at the bump test and after calibration.

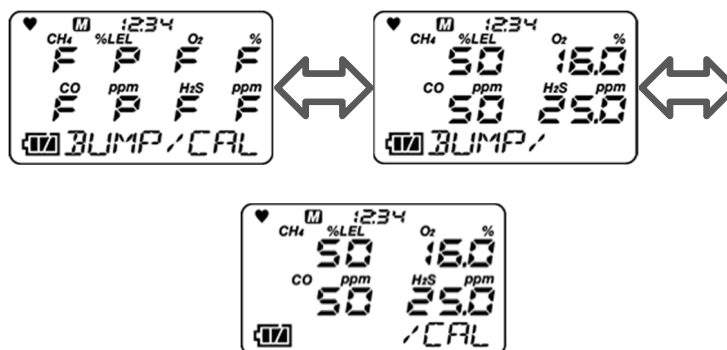

“P”: Passed, “F”: Failed

(Only those calibrated are displayed.)

- 3 Press the **MODE** button.

“END” appears and the display returns to the measurement start screen.

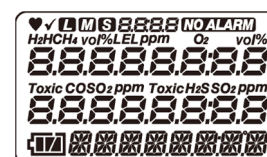



CAUTION

- For models with a combustible gas sensor installed, the screen shown on the right may be displayed if calibration is performed after a bump test failure. If this screen is displayed, some combustible gases cannot be converted using the combustible gas conversion function. For information on the types of gases that cannot be converted, see "6-2-2. Combustible conversion gas selection". If the screen shown on the right is displayed, replace the combustible gas sensor with a new one promptly.

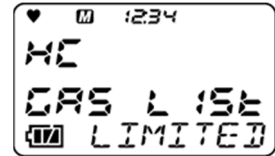

7-3-2. Switching from bump test (BUMP TEST) to measurement start screen

This section explains how to switch from bump test screen to measurement start screen.

- 1 Press the **AIR** button and select "BUMP", then press the **MODE** button.

The bump test screen is displayed.

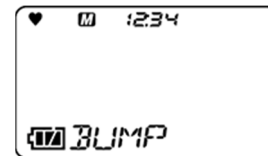

- 2 Press the **AIR** button and press "START" button.

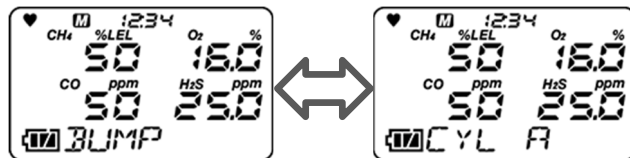

- 3 Press the **MODE** button.



The LCD lights up completely and will move to the measurement start screen.



7-4. Cleaning instructions

Clean the product if it becomes excessively dirty. Be sure to turn off the power before cleaning, and wipe clean using a rag or cloth soaked in water and firmly wrung out. Do not clean using water, organic solvents or commercially available cleaners for cleaning, as these may cause the product to malfunction.



CAUTION

- When wiping the product clean, do not splash water on it or use organic solvents like alcohol and benzene or commercially available cleaners. These may discolor or damage the surface of the product, or cause the sensors to malfunction.

NOTE

- Water may remain in the buzzer sound opening or grooves after the product has got wet. Remove any moisture as follows:
 - ① Wipe away moisture on the product thoroughly using a dry towel or cloth.
 - ② Hold the product firmly and shake it about ten times with the buzzer sound opening facing downward.
 - ③ Wipe away moisture escaping from the inside thoroughly using a towel or cloth.
 - ④ Place the product on a dry towel or cloth and allow it to stand at room temperature.

7-5. Parts replacement

7-5-1. Periodic replacement parts

The consumable parts of the product are listed below. Consumable parts should be replaced using the recommended replacement intervals as a guide.

<Recommended replacement parts list>

Name	Recommended check interval	Recommended replacement interval	Quantity	Remarks
Combustible gas sensor (NCR-6309)	6 months	3 years	1	*
O ₂ sensor (ESR-X13P)	6 months	3 years	1	*
CO/H ₂ S sensor (ESR-A1DP)	6 months	3 years	1	*
CO sensor (ESR-A13P)	6 months	3 years	1	*
CO sensor (ESR-A1CP)	6 months	3 years	1	*
H ₂ S sensor (ESR-A13i)	6 months	3 years	1	*
Dust filter	Before and after use	6 months or when contaminated	1	Part No.: 4777 9343 10 10-sheet set
Interference gas removal filter	3 months	6 months	1	For combustible gas sensor (NCR-6309) Part No.: 4777 9315 90 5-sheet set
Interference gas removal filter	3 months	6 months	1	For CO/H ₂ S sensor (ESR-A1DP) Part No.: 4777 9314 10 5-sheet set
Interference gas removal filter	3 months	6 months	1	For CO sensor (ESR-A1CP, ESR-A13P) Part No.: 4777 9316 60 5-sheet set
Interference gas removal filter	3 months	6 months	1	For H ₂ S sensor (ESR-A13i) Part No.: 4777 9317 30 5-sheet set
Rubber seals	-	3 to 6 years	1 set	*
Battery	-	Approx. 500 charging/discharging cycles	1	*

* A functional check by a qualified service engineer is required after replacement. To ensure safety and the stable operation of the product, request checking by a qualified service engineer. Contact Riken Keiki to request checking.

NOTE

- The above replacement intervals are guidelines only. Replacement intervals may vary depending on actual operating conditions. These intervals do not constitute warranty periods. Replacement intervals may vary depending on the results of regular maintenance.

7-5-2. Filter replacement

The dust filter and interference gas removal filters are consumables. Check the extent of contamination and replace them regularly.

<Dust filter replacement procedure>

- 1 Loosen the two screws on the underside of the main unit and release the two tabs.**
- 2 Detach the sensor cap and replace the dust filter with a new one.**
- 3 Reattach the sensor cap and press it until the two tabs click into place.**
- 4 Tighten the screws to secure the sensor cap.**

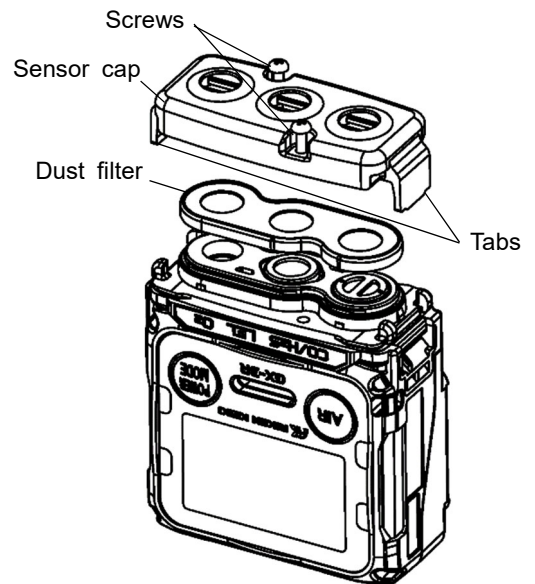



WARNING

- Install the dust filter correctly. Product performance cannot be guaranteed if it is misaligned.
- Replace the filter every six months. Replace the filter whenever it becomes contaminated even if it is less than six months.
- When replacing the dust filter or interference gas removal filters, follow the procedure described in "Filter replacement", tighten the screws securely, and make sure that the two tabs on the filter cap are securely engaged. If the screws are loose or the tabs of the sensor cap are not securely engaged, foreign matter may get inside the product. Foreign matter may also get in if even minute particles are caught between the contact surfaces.
- Do not damage the rubber seal.
- To maintain performance, we recommend replacing all of the rubber seals every three to six years, regardless of condition.
- Be sure to use only dust filters and interference gas removal filters specifically intended for use with the product (GX-3R). Use of non-approved parts may adversely affect gas detection performance and allow water to get inside the product.

<Interference gas removal filter replacement>

- 1 Loosen the two screws on the underside of the main unit and release the two tabs.**
- 2 Remove the sensor cap, dust filter, and interference gas removal filters in sequence, and replace the interference gas removal filters.**
- 3 Reseat the dust filter in its original position.**
- 4 Reattach the sensor cap and press it until the two tabs click into place.**
- 5 Tighten the screws to secure the sensor cap.**

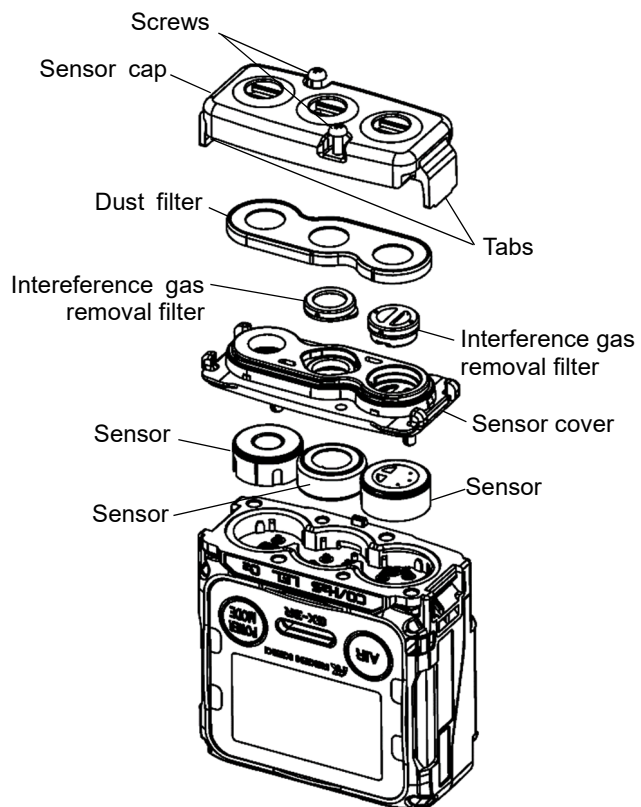



WARNING

- Install the individual interference gas removal filters correctly. If they are misaligned, gas may leak, preventing correct detection.
- Install the dust filter correctly. Product performance cannot be guaranteed if it is misaligned.
- Replace the filter every six months. Replace the filter whenever it becomes contaminated even if it is less than six months.
- When replacing the dust filter or individual interference gas removal filters, follow the procedure described in “Interference gas removal filter replacement”, tighten the screws securely, and make sure that the two tabs on the sensor cap are securely engaged. If the screws are loose or the tabs of the sensor cap are not securely engaged, foreign matter may get inside the product. Foreign matter may also get in if even minute particles are caught between the contact surfaces.
- Do not damage the rubber seal.
- To maintain performance, we recommend replacing all rubber seals every three to six years, regardless of condition.
- Be sure to use only dust filters and interference gas removal filters specifically intended for use with the product (GX-3R). Use of non-approved parts may adversely affect gas detection performance and allow water to get inside the product.
- Use only the dedicated interference gas removal filter for each sensor. Otherwise gas may not be detected correctly.

Storage and Disposal

8-1. Procedures for storage or when not in use for extended periods

The product must be stored in the following environment:

- In a dark location at normal temperature and humidity away from direct sunlight
- In a location free of gases, solvents, and vapors

Store the product in its shipping carton if this has been retained.

If the shipping carton is not available, store away from dust and dirt.

NOTE

- If the product is not to be used for extended periods, we recommend storing after the battery is discharged until the battery level icon shows one bar. Storing while fully charged may reduce battery life and accelerate battery deterioration.

8-2. Procedures for use after storage

Perform calibration if the product is used again after a period in storage.



CAUTION

- Contact Riken Keiki to request readjustment and gas calibration.
- If there is a temperature difference of 15 °C or more between the storage and usage locations, turn on the power and allow the product to stand for about 10 minutes in a similar environment to the usage location to acclimatize before performing air calibration in fresh air.

8-3. Product disposal

Dispose of the product as industrial waste (incombustible) in accordance with local regulations.



WARNING

- Never attempt to disassemble electrochemical type sensors, as they contain electrolyte. Electrolyte may cause inflammation if it comes into contact with the skin and may cause blindness if it comes into contact with the eyes. Electrolyte may discolor or decompose clothing if it comes into contact with clothing. If contact occurs, rinse the area immediately with plenty of water. Dispose of batteries in accordance with procedures specified by local authorities.

<Disposal in EU member states>

When disposing of the product in an EU member state, separate the battery as specified. The battery removed from the lithium ion battery unit must be handled in accordance with waste sorting and collection or recycling systems stipulated by the regulations of EU member states.

NOTE

Crossed-out recycle dustbin mark

- This pictogram is affixed to products which contain batteries that fall under EU Battery Directive 2006/66/EC. Such batteries need to be disposed of as specified by the latest directive. This pictogram indicates that the batteries need to be separated from ordinary waste and disposed of appropriately.



Troubleshooting

This troubleshooting chapter does not cover the causes of all possible product malfunctions. It provides brief explanations to assist in determining the causes of common problems.

If you encounter symptoms not addressed here or if problems persist even after taking corrective action, contact Riken Keiki.

9-1. Product abnormalities

Symptoms <Screen display>	Cause	Action
The power cannot be turned on.	The battery is depleted.	Charge the battery in a safe place at ambient temperatures between 0 °C and +40 °C.
	The POWER button was pressed for too short or too long a time.	To turn on the power, press the POWER button until the buzzer blips, and then release the button.
Abnormal operation	Disturbances due to sudden static electricity noise, etc.	Turn off the power once, and then turn it back on again.
Low battery voltage alarm indication <FAIL BATTERY>	Battery levels are low.	Turn off the power, and charge the battery in a safe place at ambient temperatures between 0 °C and +40 °C.
The power turns off immediately when it is turned on. <TURN OFF>	Battery levels are low.	Turn off the power, and charge the battery in a safe place at temperatures between 0 °C and +40 °C.
Air calibration is not possible. <FAIL SENSOR>	The product is not surrounded by fresh air.	Provide fresh air.
	The sensor sensitivity has degraded.	Contact Riken Keiki to request sensor replacement.
Bump testing is not possible.	The bump test gas concentration setting differs from the concentration of the bump test gas supplied.	Check to confirm that the bump test gas concentration setting matches the concentration of the bump test gas supplied.
	The sensor sensitivity has degraded.	Contact Riken Keiki to request sensor replacement.

Span adjustment is not possible. <FAIL SENSOR>	The calibration gas concentration setting differs from the concentration of the calibration gas supplied.	Check to confirm that the calibration gas concentration setting matches the concentration of the gas supplied.
	Indication value decrease due to a dry environment. (only for ESR-A1CP H2)	Allow the unit to stand overnight or more in an environment with sufficient humidity and then perform gas calibration again.
	The sensor sensitivity has degraded.	Contact Riken Keiki to request sensor replacement.

Symptoms <Screen display>	Cause	Action
A sensor abnormality is indicated in measurement mode. <FAIL SENSOR>	The sensor sensitivity has degraded.	Contact Riken Keiki to request sensor replacement. (If "FAIL" appears in place of a measured value when the power is turned on, press the MODE button to reset the alarm. The gas sensors other than the faulty sensor can still be used.)
System abnormality <FAIL SYSTEM>	A circuit abnormality occurred in the main unit.	Contact Riken Keiki for repair.
Error No. 000	Internal ROM abnormality	
Error No. 010	Internal RAM abnormality	
Error No. 021	Internal FRAM abnormality	
Error No. 031	FLASH abnormality	
Error No. 081 Error No. 082	PCB abnormality Temperature sensor abnormality	
Clock abnormality <FAIL CLOCK>	Internal clock abnormality	Set the date and time. (P. 58) If this symptom occurs frequently, the internal clock may be faulty and must be replaced. Contact Riken Keiki.
Cannot access user mode.	Forgot user mode password.	Contact Riken Keiki.
The charge LED flashes alternately green and orange.	The temperature is outside the allowable charging temperature range.	Charge at ambient temperatures between 0 °C and +40 °C.

9-2. Reading abnormalities

Symptoms <Screen display>	Cause	Action
The reading rises (or drops) and remains unchanged.	Sensor drift	Perform air calibration.
	Presence of interference gases	It is difficult to completely eliminate the effects of interference gases. Contact Riken Keiki for information on countermeasures, such as interference gas removal filters.
	Slow leakage	They may be a very small leakage (slow leakage) of the detection target gas. Leaving this unresolved may lead to dangerous situations. Take the same action as for gas alarms.
	Environmental fluctuations	Perform air calibration.
A gas alarm is triggered even though there is no problem in the measuring environment.	Presence of interference gases	It is difficult to completely eliminate the effects of interference gases. Contact Riken Keiki for information on countermeasures, such as interference gas removal filters.
	Effects of noise	Turn off the power once, and then turn it back on again (restart). If similar symptoms recur frequently, take appropriate measures to address the noise source.
Slow response	Dust filter clogging	Replace the dust filter.
	The sensor sensitivity has degraded.	Contact Riken Keiki to request sensor replacement.

Product Specifications

10-1. Specifications list

<Common specifications>

Concentration display	LCD digital (7 segments + 14 segments + icons)
Detection method	Diffusion type
Displays	Clock, battery level, operation status
Buzzer volume	Approx. 95 dB (mean value at 30 cm)
Gas alarm indication	Lamp flashing, continuous modulating buzzer sounding, gas concentration display blinking, vibration
Gas alarm pattern	Self-latching
Fault alarm/self diagnosis	System abnormality, sensor abnormality, battery voltage drop, calibration failure
Fault alarm indication	Lamp flashing, intermittent buzzer sounding, detail display
Fault alarm pattern	Self-latching
Transmission specifications	IrDA (for data logger)
Power source	Lithium ion battery
Continuous operating time	Approx. 40 hours (long-life battery mode ON, 25 °C, no alarm, no lighting) Approx. 25 hours (long-life battery mode OFF, 25 °C, no alarm, no lighting)
Operating temperature range	Temporary use environment: -40 °C to +60 °C (no sudden changes) Continuous use environment: -20 °C to +50 °C (no sudden changes)
Operating humidity range	Temporary use environment: 0 %RH to 95 %RH (no condensation) Continuous use environment: 10 %RH to 90 %RH (no condensation)
Operating pressure range	80 kPa to 120 kPa (80 kPa to 110 kPa for explosion-proof range)
Construction	Dustproof, splash-proof construction equivalent to IP66/68 (2 m, 1 h); drop resistant to 7 m
Explosion-proof construction	General ATEX/IECEx specification: Intrinsically safe explosion-proof construction and flame-proof enclosures

Explosion-proof class	<p>ATEX II1G Ex da ia IIC T4 Ga / IM1 Ex da ia I Ma (With combustible gas sensor) II1G Ex ia IIC T4 Ga / IM1 Ex ia I Ma (No combustible gas sensor)</p> <p>IECEX Ex da ia IIC T4 Ga / Ex da ia I Ma (With combustible gas sensor) Ex ia IIC T4 Ga / Ex ia I Ma (No combustible gas sensor)</p>
External dimensions	Approx. 58 mm (W) × 65 mm (H) × 26 mm (D) (excluding projections)
Weight	Approximately 100 g

<Individual sensor specifications>

Item	Detection target gas	Combustible gas	
		Isobutane (i-C ₄ H ₁₀)*	Methane (CH ₄)*
Detection range		0 to 100 %LEL (1.3 vol%)	0 to 100 %LEL (4.4 vol%)
1 digit		1 %LEL	
Alarm setpoint (General ATEX/IECEX specification)		1st alarm: 10 %LEL 2nd alarm: 25 %LEL 3rd alarm: 50 %LEL OVER alarm: 100 %LEL	
Detection principle		New ceramic type	

* The factory default setting is either CH₄ or HC (specified in the order).

Item	Detection target gas	Oxygen (O ₂)	Carbon monoxide (CO)	Hydrogen sulfide (H ₂ S)
Measuring range (General ATEX/IECEX specification)		0 to 25.0 %	0 to 500 ppm	0 to 100.0 ppm
Service range (General ATEX/IECEX specification)		25.1 to 40.0 %	501 to 2,000 ppm	100.1 to 200.0 ppm
1 digit		0.1 %	1 ppm	0.1 ppm
Alarm setpoint (General ATEX/IECEX specification)		L: 19.5 % LL: 18.0 % H: 23.5 % OVER alarm: 40.0 %	1st: 25 ppm 2nd: 50 ppm 3rd: 1200 ppm TWAalarm: 25 ppm STELalarm: 200 ppm OVERalarm: 2000 ppm	1st: 5.0 ppm 2nd: 30.0 ppm 3rd: 100.0 ppm TWAalarm: 1.0 ppm STELalarm: 5.0 ppm OVERalarm: 200.0 ppm
Detection principle		Electrochemical type		

10-2. Accessory list

Standard accessories (general ATEX/IECEX specification)

Part name	Part number
Hand strap	0888 0605 90
Belt clip (with attachment screw)	4777 9202 40
Rubber protection cover	4777 4161 10
AC adapter	2594 0898 30
EU plug	2594 0933 60
Calibration adapter (simple type)	4777 9369 30

<Optional items (sold separately)>

Part name	Part No.
Belt clip (with attachment screw)	4777 9202 40
Ultra-slim alligator clip (with attachment screw)	4777 9203 10
Belt assembly (with attachment fixture and screw)	4777 9293 30
Filter unit set (for ESR-A1DP) 5-sheet set	4777 9314 10
Filter unit set (for NCR-6309) 5-sheet set	4777 9315 90
Filter unit set (for ESR-A1CP, ESR-A13P) 5-sheet set	4777 9316 60
Filter unit set (for ESR-A13i) 5-sheet set	4777 9317 30
Dust filter 10-sheet set	4777 9343 10
Protective film 5-sheet set	4777 9296 50
Leather case	4777 4257 00
Heat-resistant case (not explosion-proof)	4777 4259 40
Manual suction kit (with sampling rod)	4777 9302 80
Manual suction kit (with float)	4777 9304 20
Manual suction kit (with weighted 30 m tube)	4777 9305 00
AU plug	2594 0932 90
EU plug	2594 0933 60
UK plug	2594 0934 30
Calibration adapter (simple type)	4777 9369 30
Calibration adapter	4777 9311 00
Charging cradle (BC-3R)	BC-3R 00
Charging cradle wall-mounting fixture	4777 4337 50
5-unit charging cable w/o AC adapter (cable length: 22.5cm)	4777 9329 70
5-unit charging cable w/o AC adapter (cable length: 60cm)	4777 9319 80
5-unit charging cable w/o AC adapter (cable length: 120cm)	4777 9333 20
Data logger management program (SW-GX-3R(EX))	9811 87

Appendix

Data logger function

The product is equipped with a data logger function that records measurement results and events such as gas alarms, fault alarms, and calibration.

NOTE

- The data logger management program (sold separately) is required to check data recorded using the data logger function. Contact Riken Keiki for more information.

The data logger provides the following five functions:

(1) Interval trend

Records the changes in measured concentration from when the power is turned on until it is turned off. For combustible gases, carbon monoxide, and hydrogen sulfide, the average value, peak value, and peak value detection time are recorded; for oxygen, the average value, minimum value, minimum value detection time, maximum value, and maximum value detection time are recorded.

Records data for the 3,600 most recent items.

If the number of items exceeds 3,600, the oldest data will be overwritten by the latest data.

If overwriting is disabled, recording stops when 3,600 is exceeded.

If 3,600 items are recorded for a single measurement, the oldest data will not be overwritten, and recording will stop even if overwriting is enabled.

* However, if the maximum recording time is exceeded, the oldest data will be deleted before reaching 3,600.

The maximum recording times corresponding to different intervals are as follows:

Interval	10 seconds	20 seconds	30 seconds	1 minute	3 minutes	5 minutes	10 minutes
Maximum recording time	10 hours	20 hours	30 hours	60 hours	180 hours	300 hours	600 hours

* The standard interval is 5 minutes.

The interval can be set using the Data Logger Management Program (sold separately).

(2) Alarm trend

When an alarm is triggered, this function records the changes in measured concentration for 30 minutes before and after the alarm occurred (one hour in total).

Alarm trend records PEAK values (minimum values for oxygen) over 5-second periods at 5-second intervals.

Records data for the eight most recent items.

If the number of items exceeds eight, the oldest data will be overwritten by the latest data.

(3) Alarm event

Records alarm occurrences as events.

This function records the time the alarm was triggered, the measurement target gas, and the type of alarm event.

Records the 100 most recent events.

If the number of events exceeds 100, the oldest data will be overwritten by the latest data.

(4) Trouble event

Records fault alarm occurrences as events.

This function records the time when the fault alarm was triggered, the measurement target gas, device information, and the type of trouble event.

Records the 100 most recent events.

If the number of events exceeds 100, the oldest data will be overwritten by the latest data.

(5) Calibration history

Records data when calibration is performed.

This function records calibration time, concentration values before and after calibration, and calibration errors.

Records data for the 100 most recent calibrations.

If the number of calibrations exceeds 100, the oldest data will be overwritten by the latest data.

NOTE

- Communication mode starts automatically if the infrared communication port of the product is positioned where IrDA communication is available while the date and time or battery level/gas alarm pattern are displayed after the power is turned on. You can also enter communication mode by pressing the **AIR** and **POWER** buttons at the same time with the infrared communication port of the product positioned where IrDA communication is available.
 - A fault alarm will be triggered if no communication connection can be confirmed for a preset duration in communication mode. If this occurs, either repeat the communication connection or turn off the power for the product.
-

100 %LEL = ppm conversion list

The following table shows the standard conversion for 100 %LEL and ppm:

		Standard	IEC (Default setting)	ISO
Methane	CH4	50,000 ppm	44,000 ppm	44,000 ppm
Isobutane	i-C4H10	18,000 ppm	13,000 ppm	15,000 ppm
Hydrogen	H2	40,000 ppm	40,000 ppm	40,000 ppm
Methanol	CH3OH	55,000 ppm	60,000 ppm	60,000 ppm
Acetylene	C2H2	15,000 ppm	23000 ppm	23000 ppm
Ethylene	C2H4	27,000 ppm	23,000 ppm	24,000 ppm
Ethane	C2H6	30,000 ppm	24,000 ppm	24,000 ppm
Ethanol	C2H5OH	33,000 ppm	31,000 ppm	31,000 ppm
Propylene	C3H6	20,000 ppm	20,000 ppm	18,000 ppm
Acetone	C3H6O	21,500 ppm	25,000 ppm	25,000 ppm
Propane	C3H8	20,000 ppm	17,000 ppm	17,000 ppm
Butadiene	C4H6	11,000 ppm	14,000 ppm	14,000 ppm
Cyclopentane	C5H10	14,000 ppm	14,000 ppm	14,000 ppm
Benzene	C6H6	12,000 ppm	12,000 ppm	12,000 ppm
N-hexane	n-C6H14	12,000 ppm	10,000 ppm	10,000 ppm
Toluene	C7H8	12,000 ppm	10,000 ppm	10,000 ppm
N-heptane	n-C7H16	11,000 ppm	8,500 ppm	8,000 ppm
Xylene	C8H10	10,000 ppm	10,000 ppm	10,000 ppm
N-nonane	n-C9H20	7,000 ppm	7,000 ppm	7,000 ppm
Ethyl acetate	EtAc	21,000 ppm	20,000 ppm	20,000 ppm
Isopropyl alcohol	IPA	20,000 ppm	20,000 ppm	20,000 ppm
Methyl ethyl ketone	MEK	18,000 ppm	15,000 ppm	15,000 ppm
Methyl methacrylate	MMA	17,000 ppm	17,000 ppm	17,000 ppm
Dimethyl ether	DME	30,000 ppm	27,000 ppm	27,000 ppm
Methyl isobutyl ketone	MIBK	12,000 ppm	12,000 ppm	12,000 ppm
Tetrahydrofuran	THF	20,000 ppm	15,000 ppm	15,000 ppm

* "IEC" is based on EN 60079-20-1: 2010 and "ISO" is based on ISO 10156: 2017.

Limited Warranty and Limitation Liability

RIKEN KEIKI CO.,LTD. (RIKEN) warrants the product to be free from defects in material and workmanship under normal use and service for a period of three years, beginning on the date of shipment to the buyer. This warranty extends only to the sale of new and unused products to the original buyer. RIKEN's warranty obligation is limited, at RIKEN's option, to repair or replacement of a defective product that is returned to a RIKEN KEIKI Quality control center located in Japan within the warranty period. In no event shall RIKEN's liability hereunder exceed the purchase price actually paid by the buyer for the Product.

This warranty does not include:

- a) fuses, disposable batteries or the routine replacement of parts due to the normal wear and tear of the product arising from use;
- b) any product which in RIKEN's opinion, has been misused, altered, neglected or damaged, by accident or abnormal conditions of operation, handling or use;
- c) any damage or defects attributable to repair of the product by any person other than an authorized dealer, or the installation of unapproved parts on the product; or

The obligations set forth in this warranty are conditional on:

- a) proper storage, installation, calibration, use, maintenance and compliance with the product manual instructions and any other applicable recommendations of RIKEN;
- b) the buyer promptly notifying RIKEN of any defect and, if required, promptly making the product available for correction. No goods shall be returned to RIKEN until receipt by the buyer of shipping instructions from RIKEN; and
- c) the right of RIKEN to require that the buyer provide proof of purchase such as the original invoice, bill of sale or packing slip to establish that the product is within the warranty period.

THE BUYER AGREES THAT THIS WARRANTY IS THE BUYER'S SOLE AND EXCLUSIVE REMEDY AND IS IN LIEU OF ALL OTHER WARRANTIES, EXPRESS OR IMPLIED, INCLUDING BUT NOT LIMITED TO ANY IMPLIED WARRANTY OF MERCHANTABILITY OR FITNESS FOR A PARTICULAR PURPOSE. RIKEN SHALL NOT BE LIABLE FOR ANY SPECIAL, INDIRECT, INCIDENTAL, OR BASED ON CONTRACT, TORT OR RELIANCE OR ANY OTHER THEORY.

Since some countries or states do not allow limitation of the term of an implied warranty, or exclusion or limitation of incidental or consequential damages, the limitations and exclusions of this warranty may not apply to every buyer. If any provision of this warranty is held invalid or unenforceable by a court of competent jurisdiction, such holding will not affect the validity or enforceability of any other provision.

Contacting RIKEN KEIKI

Email us at: intdept@rikenkeiki.co.jp

Visit RIKEN KEIKI website at: <https://www.rikenkeiki.com/>

JAPAN: +81-3-3966-1113

Revision or Abolition History

Edition	Revision	Issue date
0	First issue	2021/4/6
1	Update Declaration of Conforminty	2021/10/29
2	Error correction	2021/12/7



EU-Declaration of Conformity

Document No.: 320CE21102



We, RIKEN KEIKI Co., Ltd. 2-7-6, Azusawa, Itabashi-ku, Tokyo, 174-8744 Japan declare under our sole responsibility that the following product conforms to all the relevant provisions.

Product Name: Portable Gas Monitor
Model: GX-3R

Council Directives		Applicable Standards
2014/34/EU	ATEX Directive	EN IEC 60079-0:2018 EN 60079-1:2014 EN 60079-11:2012 EN 50303:2000
2014/30/EU	EMC Directive	EN 50270:2015
2011/65/EU	RoHS Directive	EN IEC 63000:2018

EU-Type examination Certificate No.

DEKRA 17ATEX0103 X

Notified Body for ATEX

DEKRA Certification B.V. (NB 0344)
Meander 1051, 6825 MJ Arnhem
P.O.Box 5185, 6802 ED Arnhem
The Netherlands

Auditing Organization for ATEX

DNV Product Assurance AS (NB 2460)
Veritasveien 3
1363 Høvik
Norway

The marking of the product shall include the following:



II 1 G Ex da ia IIC T4 Ga or Ex ia IIC T4 Ga and
I M1 Ex da ia I Ma or Ex ia I Ma

Alternative Marking:

da ia:with thermo catalytic gas sensor NCR-6309
ia:without thermo catalytic gas sensor NCR-6309

Place: Tokyo, Japan

Date: Sep. 22, 2021

Takakura Toshiyuki
General manager
Quality Control Center



EU-Declaration of Conformity

Document No.: 320CE21077



We, RIKEN KEIKI Co., Ltd. 2-7-6, Azusawa, Itabashi-ku, Tokyo, 174-8744 Japan declare under our sole responsibility that the following product conforms to all the relevant provisions.

Product Name: Battery Charger
Model: BC-3R

Council Directives		Applicable Standards
2011/65/EU	RoHS Directive	EN IEC 63000:2018

Place: Tokyo, Japan

Date: Sep. 22, 2021

Takakura Toshiyuki
General manager
Quality Control Center