

Portable Gas Detector GX-9000 Series

**GX-9000
GX-9000H**

**Operating Manual
(PT0-211)**

RIKEN KEIKI Co., Ltd.

2-7-6 Azusawa, Itabashi-ku, Tokyo, 174-8744, Japan

Phone: +81-3-3966-1113

Fax: +81-3-3558-9110

E-mail: intdept@rikenkeiki.co.jp

Web site: <https://www.rikenkeiki.co.jp/english/>

Contents

| | | |
|----|--|----|
| 1. | Product Overview | 5 |
| | 1-1 Introduction | 5 |
| | 1-2 Intended use | 6 |
| | 1-3 Checking the detection target gases and product model | 7 |
| | 1-4 DANGER, WARNING, CAUTION, and NOTE | 10 |
| | 1-5 Checking standards and explosion-proof specifications | 11 |
| 2. | Important Safety Information | 12 |
| | 2-1 Danger information | 12 |
| | 2-2 Warnings | 14 |
| | 2-3 Precautions | 16 |
| | 2-4 Safety information | 20 |
| 3. | Product Configuration | 23 |
| | 3-1 Main unit and accessories | 23 |
| | 3-1-1 Main unit | 23 |
| | 3-1-2 Accessories | 24 |
| | 3-1-3 Optional accessories | 25 |
| | 3-2 Part names and functions | 30 |
| | 3-2-1 Main unit and battery unit | 30 |
| | 3-2-2 Control panel | 32 |
| | 3-2-3 LCD display | 34 |
| 4. | Alarm Functions | 36 |
| | 4-1 Gas alarm types | 36 |
| | 4-2 Gas alarm setpoints | 36 |
| | 4-3 Gas alarm patterns | 42 |
| | 4-4 Fault alarm patterns | 45 |
| | 4-5 Outside operating temperature range warning | 46 |
| 5. | Usage Instructions | 47 |
| | 5-1 Usage note | 47 |
| | 5-2 Removing and attaching the battery unit and charging | 48 |
| | 5-2-1 Removing and attaching the battery unit | 48 |
| | 5-2-2 Charging the lithium ion battery unit (BUL-9000) | 50 |
| | 5-2-3 Replacing the dry battery unit (BUD-9000) | 52 |
| | 5-3 Connecting the gas sampling rod | 54 |
| | 5-4 Turning on the power | 56 |
| | 5-5 Selecting hydrogen sulfide measurement mode range (GX-9000H) | 61 |
| | 5-6 Performing fresh air adjustment in measurement mode | 62 |
| | 5-7 Measurement | 65 |
| | 5-7-1 Measuring gas concentration | 68 |
| | 5-7-2 Combustible gas concentration range changeover points | 70 |
| | 5-7-3 Basic operating flow in measurement mode | 71 |
| | 5-7-4 Confirmation beep operation | 73 |
| | 5-8 Recording gas concentration logs (snap logger) | 74 |
| | 5-9 Stopping the pump | 75 |
| | 5-10 Turning off the power | 76 |
| 6. | Settings (Display Mode) | 77 |
| | 6-1 Display mode items | 77 |
| | 6-2 Switching to display mode | 80 |

| | | |
|-------|---|-----|
| 6-3 | Checking settings | 81 |
| 6-3-1 | Clearing the PEAK value..... | 81 |
| 6-3-2 | Displaying the snap logger (gas concentration/alarm status)..... | 82 |
| 6-3-3 | Displaying adjustment records..... | 83 |
| 6-3-4 | Displaying bump test records..... | 84 |
| 6-3-5 | Displaying alarm setpoints..... | 85 |
| 6-4 | Display mode settings..... | 87 |
| 6-4-1 | Setting the NCF/TEF sensor range..... | 87 |
| 6-4-2 | Combustible gas conversion gas selection..... | 88 |
| 6-4-3 | Volatile organic compound (VOC) conversion gas selection..... | 90 |
| 6-4-4 | Setting the user ID..... | 92 |
| 6-4-5 | Setting the station ID..... | 93 |
| 6-4-6 | Setting a Bluetooth device connection..... | 94 |
| 6-4-7 | Setting the buzzer volume..... | 95 |
| 6-4-8 | Switching display language to English (ATEX/IECEx model)..... | 96 |
| 6-4-9 | Switching display language to Japanese (Japan Ex model)..... | 97 |
| 7. | Settings (User Mode)..... | 98 |
| 7-1 | User mode display items..... | 98 |
| 7-2 | Switching to user mode..... | 100 |
| 7-3 | Gas alarm settings..... | 101 |
| 7-3-1 | Setting alarm setpoints..... | 101 |
| 7-3-2 | Setting alarm type..... | 105 |
| 7-3-3 | Setting alarm pattern..... | 107 |
| 7-3-4 | Resetting alarm setpoints..... | 108 |
| 7-3-5 | Enabling/disabling the alarm function..... | 109 |
| 7-4 | Other user mode settings..... | 110 |
| 7-4-1 | Setting the buzzer..... | 110 |
| 7-4-2 | Enabling/disabling CO ₂ fresh air adjustment..... | 111 |
| 7-4-3 | Selecting gas type for base gas adjustment..... | 112 |
| 7-4-4 | Setting the date and time..... | 113 |
| 7-4-5 | Setting the display language..... | 114 |
| 7-4-6 | Displaying version information..... | 115 |
| 8. | Maintenance..... | 117 |
| 8-1 | Maintenance intervals and items..... | 117 |
| 8-2 | Performing gas adjustment..... | 119 |
| 8-2-1 | Preparation for gas adjustment..... | 119 |
| 8-2-2 | Performing fresh air adjustment..... | 124 |
| 8-2-3 | Performing CO ₂ zero adjustment..... | 126 |
| 8-2-4 | Performing base gas adjustment..... | 129 |
| 8-2-5 | Setting span adjustment..... | 131 |
| 8-2-6 | Performing span adjustment..... | 137 |
| 8-3 | Performing bump tests..... | 139 |
| 8-4 | Performing alarm tests..... | 141 |
| 8-5 | Cleaning procedure..... | 142 |
| 8-6 | Parts replacement..... | 143 |
| 8-6-1 | Periodic replacement parts..... | 143 |
| 8-6-2 | Gas sampling rod dust filter replacement..... | 145 |
| 8-6-3 | Replacing of the main unit's filter/sensor..... | 146 |
| 8-6-4 | With flow monitor Filter tube dust filter replacement..... | 150 |
| 8-6-5 | VOC sensor maintenance..... | 151 |
| 9. | Storage and Disposal..... | 156 |
| 9-1 | Procedures for storage or when not in use for extended periods..... | 156 |

| | | |
|--------|---|-----|
| 9-2 | Procedures for use after storage | 157 |
| 9-3 | Product disposal | 157 |
| 10. | Troubleshooting | 158 |
| 10-1 | Product abnormalities | 158 |
| 10-2 | Reading abnormalities | 162 |
| 11. | Product Specifications | 163 |
| 11-1 | Product specifications..... | 163 |
| 11-1-1 | GX-9000 specifications | 163 |
| 11-1-2 | GX-9000H specifications | 165 |
| 11-2 | Sensor specifications..... | 166 |
| 11-2-1 | Combustible gas sensors..... | 166 |
| 11-2-2 | Carbon dioxide sensor | 171 |
| 11-2-3 | Oxygen sensor | 172 |
| 11-2-4 | Toxic gas sensors | 174 |
| 11-2-5 | VOC sensors..... | 178 |
| 12. | Appendix | 179 |
| 12-1 | Data logger function..... | 179 |
| 12-2 | 100 %LEL conversion list | 181 |
| 12-3 | Zero suppression function | 182 |
| 12-4 | Zero follower function | 183 |
| 12-5 | List of interference gases for electrochemical type sensors | 184 |
| 12-6 | Radio law certification..... | 187 |
| 12-7 | Limited Warranty and Limitation Liability..... | 189 |

1

Product Overview

1-1 Introduction

Thank you for purchasing this GX-9000 Series Portable Gas Detector ("product" hereinafter).

The product should be used only by fully-trained personnel.

Maintenance procedures described in this manual should be performed only by fully-trained personnel. Any maintenance procedure not described in this manual must be performed by RIKEN KEIKI or our certified service engineers. Please contact RIKEN KEIKI.

This operating manual describes product operating procedures and specifications. It provides information essential to correct use of the product.

Make sure you have read and fully understood the contents of this manual before using the product. Keep this operating manual on hand to allow ready reference during use.

The contents of this manual are subject to change without notice to allow product improvements. Any duplication or reproduction of this manual without permission is prohibited, whether in whole or in part. Also refer to the corresponding manuals when using the following optional products:

- RK Link dedicated portable gas detector app^{*1} Operating Manual (PT9E-022)
- SW-9000 Series Data Logger Management Program Operating Manual (PT0E-208)
- MT-9000 Series Setup Program Operating Manual (PT0E-209)

*1: Can be installed on a smartphone from Google Play or App Store free of charge.

*2: Can be installed on a PC from the separately sold CD-ROM.

*3: Can be installed on a PC from the RIKEN KEIKI website.

RIKEN KEIKI accepts no liability for accidents or damage resulting from use of the product, whether within or outside the warranty period.

Review the warranty policy described in '12-7 Warranty policy'.

The product includes [Bluetooth®](#) functionality. If the function is enabled (selected at the time of purchase), turning the setting on allows communication with a smartphone on which the RK Link dedicated portable gas detector app has been installed.

Google Play is a trademark of Google LLC.

App Store is a service mark of Apple Inc.

Bluetooth® is a registered trademark of Bluetooth SIG, Inc. and is used by RIKEN KEIKI under license.

<Models covered by this operating manual>

Before using the product, please confirm that the model of the product you purchased matches the model of the product covered by this operating manual.

- GX-9000
- GX-9000H

1-2 Intended use

This product is a multi-gas detector capable of detecting combustible gases (%LEL), oxygen (O_2) (oxygen deficiency, excess oxygen), carbon monoxide (CO), hydrogen sulfide (H_2S), carbon dioxide (CO_2), ammonia (NH_3), chlorine (Cl_2), ozone (O_3), hydrogen chloride (HCl), sulfur dioxide (SO_2), hydrogen cyanide (HCN), and volatile organic compounds (VOCs) in air, and high concentrations of combustible gases (vol%) and oxygen (O_2) in nitrogen (N_2) or inert gases.

One unit measures up to six different gas concentrations. The alarm function triggers an alarm if gas concentrations reach or exceed the alarm setpoint.

The product is capable of measuring methane (CH_4), commonly used in general plants and oil tankers, as well as general combustible gases such as isobutane (HC (i-C₄H₁₀)), hydrogen (H_2), and acetylene (C_2H_2).

Note that the measurement results provided by the product do not constitute a guarantee with respect to life or safety.

Check again the specifications before use to perform gas measurement correctly in accordance with the intended purpose.

The following sensors can be installed in the product:

| Sensor type | Detection principle | Sensor model |
|------------------------|---------------------|--|
| Combustible gas sensor | NCF sensor | New ceramic type NCF-6322P (CH_4) Japan Ex model NCF-6322P M(CH_4) ATEX/IECEx model NCF-6322P (HC (i-C ₄ H ₁₀)/ H_2 /C ₂ H ₂) |
| | TEF sensor | Thermal conductivity type TEF-7520P (CH_4 /HC (i-C ₄ H ₁₀)/ H_2) |
| | IRF sensor | Non-dispersive infrared type (NDIR) IRF-4341 (CH_4) IRF-4345 (HC (i-C ₄ H ₁₀)) |
| Carbon dioxide sensor | IRF sensor | Non-dispersive infrared type (NDIR) IRF-4443 (CO_2 , vol%) IRF-4433 (CO_2 , ppm) |
| Oxygen sensor | ESR sensor | Electrochemical type ESR-X13P (O_2) |
| Toxic gas sensor | ESR sensor | Electrochemical type ESR-A13i (H_2S) (low concentrations) ESR-A13P (CO) |
| | ESF sensor | Electrochemical type ESF-A24R2 (H_2S) (high concentrations) ESF-B242 (NH_3) ESF-C930 (Cl_2) ESF-B249 (O_3) ESF-A24E2 (HCl) ESF-A24D4 (SO_2) ESF-A24D (HCN) Japan Ex model ESF-A24DX (HCN) ATEX/IECEx model |
| VOC* sensor | PIF sensor | Photo-ionization type (PID) PIF-001 (VOC, 10.6 eV, ppb) PIF-002 (VOC, 10.6 eV, ppm) PIF-003 (VOC, 10.0 eV, ppm) |

* Volatile organic compounds

1-3 Checking the detection target gases and product model

The detection target gases vary depending on the particular sensors installed in the product. Check the detection target gases using the product code before use.

The GX-9000 Series alphanumeric product codes are categorized as follows:

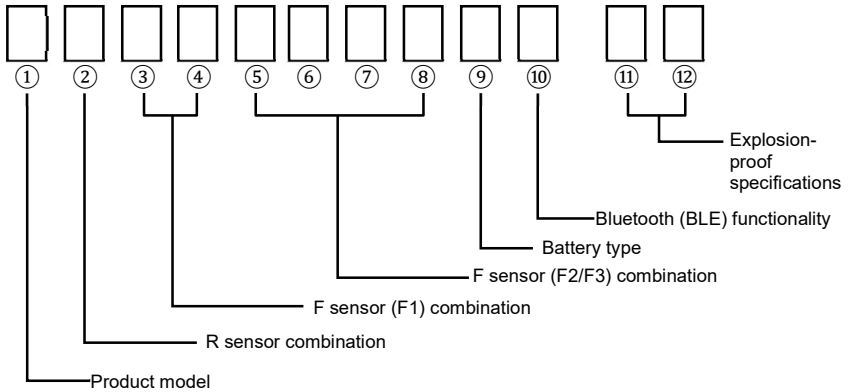

<GX-9000/GX-9000H>

①: Product model

| Symbol | Details |
|--------|----------|
| C | GX-9000 |
| D | GX-9000H |

②: R sensor combination

| Symbol | R1 | R2 | R3 |
|--------|----------------------------|-----------------------------|--------------------|
| 0 | N/A (dummy sensor) | | |
| 1 | ESR-X13P (O ₂) | ESR-A13i (H ₂ S) | ESR-A13P (CO) |
| 2 | ESR-X13P (O ₂) | ESR-A13i (H ₂ S) | N/A (dummy sensor) |
| 3 | ESR-X13P (O ₂) | N/A (dummy sensor) | ESR-A13P (CO) |
| 4 | ESR-X13P (O ₂) | N/A (dummy sensor) | |
| 5 | N/A (dummy sensor) | ESR-A13i (H ₂ S) | ESR-A13P (CO) |
| 6 | N/A (dummy sensor) | ESR-A13i (H ₂ S) | N/A (dummy sensor) |
| 7 | N/A (dummy sensor) | | ESR-A13P (CO) |

<GX-9000>**③④: F sensor (F1) combination**

| Symbol | F1 |
|--------|---|
| 00 | N/A (dummy sensor) |
| P1 | PIF-001 (VOC, 10.6 eV, ppb) |
| P2 | PIF-002 (VOC, 10.6 eV, ppm) |
| P3 | PIF-003 (VOC, 10.0 eV, ppm) |
| E1 | ESF-B242 (NH ₃) |
| E2 | ESF-C930 (Cl ₂) ^{*1} |
| E3 | ESF-B249 (O ₃) ^{*1} |
| E4 | ESF-A24E2 (HCl) |
| E5 | ESF-A24D4 (SO ₂) |
| E6 | ESF-A24D (HCN) Japan Ex model |
| E7 | ESF-A24DX (HCN) ATEX/IECEx model |
| R5 | IRF-4443 (CO ₂ , vol%) ^{*2} |
| R6 | IRF-4433 (CO ₂ , ppm) ^{*2} |

*1: When this sensor is selected, ESR-A13i (H₂S) cannot be selected for installation in ②: R sensor combination.

*2: This sensor can be selected only when NCF-6322P / NCF-6322P M is installed for F3 in ⑤ to ⑧ F sensor (F2, F3) combination.

⑤ to ⑧: F sensor (F2, F3) combination

| Symbol | F2 | F3 |
|--------|--|--|
| 00 00 | N/A (dummy sensor) | |
| 00 N1 | N/A (dummy sensor) | NCF-6322P (CH ₄) Japan Ex model ^{*3} |
| T1 N1 | TEF-7520P (CH ₄) | NCF-6322P (CH ₄) Japan Ex model ^{*3} |
| 00 N2 | N/A (dummy sensor) | NCF-6322P (HC (i-C ₄ H ₁₀)) |
| T2 N2 | TEF-7520P (HC (i-C ₄ H ₁₀)) | NCF-6322P (HC (i-C ₄ H ₁₀)) |
| 00 N4 | N/A (dummy sensor) | NCF-6322P (H ₂) ^{*4} |
| T4 N4 | TEF-7520P (H ₂) ^{*4*5} | NCF-6322P (H ₂) ^{*4} |
| 00 N5 | N/A (dummy sensor) | NCF-6322P (C ₂ H ₂) ^{*4*5} |
| 00 N6 | N/A (dummy sensor) | NCF-6322P M(CH ₄) ATEX/IECEx model |
| T1 N6 | TEF-7520P (CH ₄) | NCF-6322P M(CH ₄) ATEX/IECEx model |
| R1 00 | IRF-4341 (CH ₄) | N/A (dummy sensor) |
| R1 R5 | IRF-4341 (CH ₄) | IRF-4443 (CO ₂ , vol%) |
| R1 R6 | IRF-4341 (CH ₄) | IRF-4433 (CO ₂ , ppm) |
| R2 00 | IRF-4345 (HC (i-C ₄ H ₁₀)) | N/A (dummy sensor) |
| R2 R5 | IRF-4345 (HC (i-C ₄ H ₁₀)) | IRF-4443 (CO ₂ , vol%) |
| R2 R6 | IRF-4345 (HC (i-C ₄ H ₁₀)) | IRF-4433 (CO ₂ , ppm) |
| 00 R5 | N/A (dummy sensor) | IRF-4443 (CO ₂ , vol%) |
| 00 R6 | N/A (dummy sensor) | IRF-4433 (CO ₂ , ppm) |

*3: ATEX/IECEx specification has been changed from NCF-6322P (symbol: N1) to NCF-6322P M (symbol: N6) since 2025/5 shipments. The NCF-6322P (symbol: N1) is installed in earlier products, but when replacing the ATEX/IECEx-specification sensor, please make arrangements for replacement parts as NCF-6322P M (symbol: N6). (Refer to '8-6-1 Periodic Replacement Parts')

*4: When this sensor is selected, ESR-A13P (CO) cannot be selected for installation in ②: R sensor combination.

*5: When this sensor is selected, ESF-A24E2 (HCl), ESF-A24D4 (SO₂), ESF-A24D (HCN) and ESF-A24DX (HCN) cannot be selected for installation in ③④: F sensor (F1) combination.

<GX-9000H>**③④: F sensor (F1) combination**

| Symbol | F1 |
|--------|------------------------------|
| E8 | ESF-A24R2 (H ₂ S) |

⑤ to ⑧: F sensor (F2, F3) combination

| Symbol | F2 | F3 |
|--------|--------------------|---|
| 00 00 | N/A (dummy sensor) | |
| 00 R1 | N/A (dummy sensor) | IRF-4341 (CH ₄) |
| 00 R2 | N/A (dummy sensor) | IRF-4345 (HC (i-C ₄ H ₁₀)) |

<GX-9000/GX-9000H>**⑨: Battery type**

| Symbol | Specifications |
|--------|-----------------------------------|
| L | Lithium ion battery unit BUL-9000 |
| D | Dry battery unit BUD-9000 * |

*: If JG type approval specification is selected, BUD-9000 cannot be selected.

⑩: Bluetooth (BLE) functionality

| Symbol | Specifications |
|--------|--------------------------|
| 0 | Not Bluetooth compatible |
| 1 | Bluetooth compatible |

⑪⑫: Explosion-proof specifications

| Symbol | Specifications |
|--------|----------------|
| 00 | Japan Ex |
| 50 | ATEX/IECEX |



<Example product codes>

The specifications for the product code examples listed here are as follows:

| Example product code | C1P1T1N1L0 00 | C7P2R100D1 50 | D2E800R1L1 00 |
|--------------------------------|----------------|--------------------------------|--------------------------------|
| Product model | GX-9000 | GX-9000 | GX-9000H |
| R sensor | R1 | ESR-X13P (O ₂) | ESR-X13P (O ₂) |
| | R2 | ESR-A13i (H ₂ S) | ESR-A13i (H ₂ S) |
| | R3 | ESR-A13P (CO) | N/A |
| F sensor | F1 | PIF-001 (VOC, 10.6 eV, ppb) | PIF-002 (VOC, 10.6 eV, ppm) |
| | F2 | TEF-7520P (CH ₄) | IRF-4341 (CH ₄) |
| | F3 | NCF-6322P (CH ₄) | N/A |
| Battery type | BUL-9000 | BUD-9000 | BUL-9000 |
| Bluetooth (BLE) functionality | Not compatible | Compatible | Compatible |
| Explosion-proof specifications | Japan Ex | ATEX/IECEX | Japan Ex |

1-4 DANGER, WARNING, CAUTION, and NOTE

This operating manual uses the following categories to indicate potential damage/hazards if the user disregards the information provided and uses the product incorrectly:

| | |
|--|--|
|  DANGER | This indicates situations in which improper handling may result in fatal or serious injury or significant property damage. |
|  WARNING | This indicates situations in which improper handling may result in serious injury or significant property damage. |
|  CAUTION | This indicates situations in which improper handling may result in minor injury or minor property damage. |

Additionally, usage recommendations are indicated as follows:

| | |
|-------------|---|
| NOTE | This indicates items that will be helpful to know when using the product. |
|-------------|---|

1-5 Checking standards and explosion-proof specifications

The product specifications will vary depending on the specific standards and explosion-proof certification. Check the actual product specifications before use. Check the affixed nameplate for product specifications.

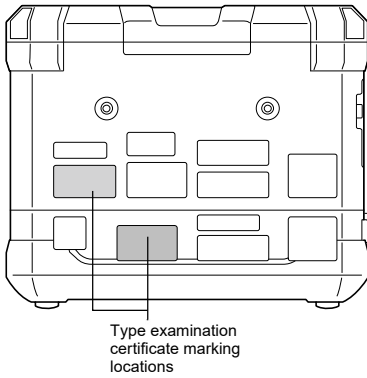

Typical nameplates for explosion-proof electrical equipment type certified (Japan EX) model

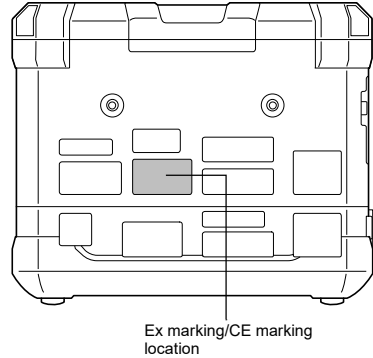

Typical nameplate for ATEX/IECEx model

2

Important Safety Information

To maintain the performance of the product and to ensure safe use, always observe the following DANGER, WARNING, and CAUTION instructions.

2-1 Danger information



DANGER

Main unit explosion-proofing

- Do not modify or alter the circuits or configuration.
- When carrying and using the product in hazardous areas, the following general precautions must be observed to safeguard against static electricity hazards:
 - Wear anti-static clothing and conductive shoes (anti-static work shoes).
 - When using the product indoors, stand on a conductive work floor (with a leakage resistance of 10 MΩ or less).
- The product is explosion-proof. With the exception of specified components, it cannot be disassembled or modified.
- Do not subject the buzzer opening on the main unit to impact.
- The ratings for the main unit are as follows:

| | |
|---------------|--|
| Power source: | User-replaceable lithium ion battery unit model BUL-9000 or user-replaceable dry battery unit BUD-9000 |
|---------------|--|

Ambient temperature*: -40 °C to +60 °C

* Ambient temperature refers to the temperature range in which the explosion-proof performance can be maintained. It does not refer to the temperature range in which product performance is guaranteed.

For information on the operating temperature range, refer to '11-1 Product specifications' and '11-2 Sensor specifications'.

Battery unit explosion-proofing

- Do not modify or alter the circuits or configuration.
- When carrying and using the product in hazardous areas, the following general precautions must be observed to safeguard against static electricity hazards:
 - Wear anti-static clothing and conductive shoes (anti-static work shoes).
 - When using the product indoors, stand on a conductive work floor (with a leakage resistance of 10 MΩ or less).
- The battery unit can be used only after evaluation in combination with a main unit and only when combined with a main unit that has passed the type examination. The main unit to which the battery unit can be connected is the GX-9000 or GX-9000H.
- The ratings for the BUL-9000 lithium ion battery unit are as follows:

| | |
|---|----------------------|
| Power source: | 3.7 V DC, 250 mA |
| Battery charging contact allowable voltage: | 5.7 V DC (SELV only) |
| Ambient temperature*: | -40 °C to +60 °C |

* Ambient temperature refers to the temperature range in which the explosion-proof performance can be maintained. It does not refer to the temperature range in which product performance is guaranteed.

For information on the operating temperature range, refer to '11-1 Product specifications' and '11-2 Sensor specifications'.

- The ratings for the BUD-9000 dry battery unit are as follows:

Power source: 4.5 V DC, 250 mA

Interface connector allowable voltage: 5.7 V DC (SELV only)

Ambient temperature*: -40 °C to +60 °C

* Ambient temperature refers to the temperature range in which the explosion-proof performance can be maintained. It does not refer to the temperature range in which product performance is guaranteed.

For information on the operating temperature range, refer to '11-1 Product specifications' and '11-2 Sensor specifications'.

Usage

- If measuring inside manholes or enclosed spaces, never lean over or look into the manhole or enclosed space. There is a danger that oxygen-deficient air or other gases may be discharged from such locations.

Gas outlet

- Oxygen-deficient air or other gas may be discharged from the gas outlet. Never breathe in this air.
 - High-concentration (100 %LEL or higher) gas may be discharged. Be sure to maintain a safe distance from flame sources.
-

2-2 Warnings



WARNING

If an abnormality occurs

- Contact RIKEN KEIKI immediately. Visit our website for information on the nearest RIKEN KEIKI office.
Website: <https://www.rikenkeiki.co.jp/english/>

Sampling point pressure

- The product is designed to draw in gas at atmospheric pressure. There is a danger that detection target gas may leak from inside the product if an excessive pressure is applied to the gas inlet (GAS IN) or outlet (GAS OUT) of the product. Be careful to avoid excessive pressure during use.
- Do not connect a gas sampling tube directly to locations pressurized above atmospheric pressure. Doing so may result in damage to the internal pipes.

Sensor handling

- Never disassemble the sensor.
Electrochemical type sensors in particular contain hazardous electrolyte. Contact with electrolyte may result in skin inflammation. Contact with eyes may result in blindness. Contact with clothing may result in discoloration or damage to the fabric.
If contact occurs, rinse the area immediately with plenty of water.
- Do not use any gas other than nitrogen (N₂) as the balance gas when adjusting the oxygen sensor. Otherwise, oxygen (O₂) reading errors will increase, preventing accurate measurement.

Fresh air adjustment in surrounding atmosphere

- When fresh air adjustment is performed in the surrounding atmosphere, check to confirm that the air is clean before starting. The presence of miscellaneous or interference gases will make it impossible to adjust the product correctly, resulting in the danger of erroneous detection when actual gas leaks occur.

Action if a gas alarm occurs

- A gas alarm indicates an extreme hazard. The user must take appropriate action after taking appropriate steps to ensure safety.

Battery level check

- Check the battery level before using the product. The batteries may be depleted when the product is used for the first time or after extended periods without use. Always fully charge or replace with new batteries before use.
- Gas measurement will not be possible if a battery low voltage alarm occurs. If the alarm occurs during use, turn off the power and promptly charge or replace the batteries in a safe place.

Miscellaneous

- Do not use the product in rain or submerge it in water. Doing so may cause water to enter the product, resulting in the failure of the sensors or the product. Even if this does not result in failure, a wet sensor may be unable to detect gases.
- When using the product, always make that the product is able to suck in air. If the product inlet is covered or blocked, correct measurement cannot be obtained, possibly leading to accidents.
- Do not leave the product exposed for extended periods to temperatures -10 °C or below. Doing so may cause the pump valve to freeze, disabling normal operation of the pump.

- Do not dispose of the product into fire.
 - Do not attempt to wash the product, either in a washing machine or an ultrasonic cleaning machine.
 - Do not block the buzzer sound opening. Doing so will muffle or silence the audible warning.
 - Do not remove the battery unit while the power is turned on.
 - Do not subject the product to vibration or impact, such as by carrying it around with the water trap (sold separately) fitted to it. Doing so may damage the gas inlet (GAS IN).
-

2-3 Precautions



CAUTION

Avoid use in locations where oil or chemicals may splash. Avoid deliberately submerging the product in water.

- Avoid using the product in locations where the product may be splashed with liquids such as oil and chemicals.
- The product is not designed to be water pressure resistant. Avoid exposing the product directly to water from a faucet or shower as water may get in the product if it is subjected to water pressure. Note that the product is waterproof against freshwater and tap water, but it is not waterproof against hot water, saltwater, detergent, chemicals, or perspiration.
- The gas inlet (GAS IN) and outlet (GAS OUT) are not waterproof. Take care to prevent water such as rainwater from entering these parts. Failure to do so may prevent gas measurement.
- Do not place the product in locations where water or dirt accumulates. Placing the product in such locations may cause malfunction due to water or dirt ingress into the buzzer sound opening or gas inlet (GAS IN), etc.
- The sensor sensitivity will be significantly reduced if dirty water, dust, or metal particles are drawn in. Take adequate care when using in such environments.
- The dustproof and waterproof construction rating of IP66/68 (IPx8 indicates no water ingress will occur if the product is immersed to a depth of two meters for one hour) does not refer to whether or not the product is capable of detecting gas during or after exposure to the corresponding conditions. Be sure to remove any dust or water.

Do not use the product in locations outside the operating temperature range.

- Avoid using the product at temperatures outside the operating temperature range.
- Avoid using the product for extended periods in locations where it is exposed to direct sunlight.
- Avoid storing the product inside parked vehicles in hot weather.

Use within the specified operating humidity range to avoid condensation in the product or gas sampling tube.

- Condensation forming inside the product or gas sampling tube may cause clogging or gas adsorption, which may prevent accurate gas measurement. Condensation must be avoided at all costs. In addition to the usage environment, carefully monitor the temperature and humidity of the sampling point to prevent condensation forming inside the product.

Do not use walkie-talkies near the product.

- Radio waves from walkie-talkies or other radio transmitters near the product may affect readings. If walkie-talkies or other radio wave transmitting devices are used, these must be used away from the product where they do not affect operation.
- Do not use the product near devices that emit strong electromagnetic radiation (high-frequency or high-voltage devices).

Verify that the flow confirmation icon is rotating.

- Correct gas measurement is not possible if the flow confirmation icon is not rotating. Check to confirm that the suction is operating correctly.

Verify that the operating status icon is blinking.

- If the operating status icon on the LCD is not blinking, gas cannot be measured correctly. (Refer to '3-2-3 LCD display'.)

Be sure to perform regular maintenance.

- The product is a safety device and must be regularly maintained without fail. Continuing to use the product without maintenance will result in sensor sensitivity variations, preventing accurate gas measurement.

Miscellaneous

- Pressing buttons unnecessarily may change the settings, preventing alarms from activating correctly. Avoid performing any operations not described in this operating manual.
- Do not drop the product or subject it to impact. Doing so may reduce accuracy.
- Do not use the product while charging it.
- Do not prod the buzzer sound opening with sharp objects. Doing so may result in malfunctions or damage to the product and allow foreign matter inside.
- Do not remove the panel sheet on the LCD display. Doing so will impair dustproof performance.

Sensors

- Do not expose the product to sudden pressure fluctuations. Oxygen readings (O₂) will vary temporarily, preventing accurate measurement.
- If highly adsorptive gas has been sucked in, allow the product to suck in clean air, and confirm that the reading returns to zero before use.
- If the separately sold sampling tube with float or weight is used when measuring highly adsorptive gas, the gas may be adsorbed inside the tube, resulting in a lower concentration reading than the actual concentration of the detection target gas at the measurement point.
- Some sensors may exhibit positive sensitivity to gases other than the detection target gas. Note that when the product is used in an environment where such gases are present, the reading may be higher than the actual concentration of the detection target gas present.

<Examples of interference gases to which the sensor exhibits positive sensitivity>

| Sensor detection principle | Detection target gas name | Interference gas |
|-------------------------------------|---|---------------------------------------|
| New ceramic type | Methane (CH ₄)/isobutane (HC (i-C ₄ H ₁₀))/hydrogen (H ₂)/acetylene (C ₂ H ₂) | All combustible gases |
| Non-dispersive infrared type (NDIR) | Methane (CH ₄)/isobutane (HC (i-C ₄ H ₁₀)) | Hydrocarbon combustible gases |
| Photo-ionization type (PID) | Volatile organic compounds (VOCs) | All volatile organic compounds (VOCs) |

- Due to their operating principle, electrochemical type sensors may exhibit negative sensitivity to certain interference gases. In environments where interference gases are present, the reading may be lower than the actual concentration of the detection target gas present, and particularly at high concentrations, the reading may even turn negative, triggering an M OVER alarm. (Refer to '12-5 List of interference gases for electrochemical type sensors'.)
- Due to their operating principles, infrared type CO₂ sensors may exhibit negative sensitivity when high concentrations of hydrocarbons are present.
- Note that if new ceramic type combustible gas sensors are used in an environment where silicone compounds, halides, high-concentration sulfides, or high-concentration solvent gases are present, sensor life may be reduced, sensitivity to combustible gases may deteriorate, and accurate readings may not be obtained. If use in such environments is unavoidable, use for the shortest possible time and allow the product to suck in clean air afterward. Confirm that the reading returns to normal and is stabilized.
- An oxygen concentration of at least 10 vol% is required in order for the new ceramic type combustible gas sensor (%LEL) in the product to accurately measure gases and display concentrations.
- Due to the sensor characteristics, an accurate reading may not be displayed immediately after turning on the power. Allow the product to warm up for at least one minute after turning on the power to allow the reading to stabilize before use. Allow the product to warm up for at least 10 minutes after turning on the power before performing gas adjustment.
- The reading of the carbon monoxide sensor may rise if exposed to high concentrations of volatile organic compounds (VOCs). If the reading rises and will not return, the activated carbon filter in the carbon monoxide sensor must be replaced. For information on activated carbon filter replacement, contact RIKEN KEIKI.
- The zero point for carbon monoxide and hydrogen sulfide sensors may fluctuate at low or high temperatures. If this occurs, perform fresh air adjustment in the ambient atmosphere.

- The hydrogen sulfide sensor may exhibit temporary fluctuations if exposed to sudden temperature variations. Allow the product to stand and acclimatize in the ambient atmosphere.
- If the VOC sensor is exposed to high concentrations of methane (CH₄), ethane (C₂H₆), propane (C₃H₈), or other gases, [----] may appear on the concentration display, the lamps may flash, and the buzzer may sound, temporarily disabling measurement. In environments where these gases are present, even if the concentration display does not indicate [----], be aware that the VOC concentration may not be accurately measured.

Note that, even if the VOC sensor concentration display indicates [----], other unaffected sensors can continue measurement.

<Example interference gases causing [----] to be displayed on the VOC sensor concentration display>

| Interference gas | Concentration |
|--|-----------------|
| Methane (CH ₄) | 6 vol% or more |
| Ethane (C ₂ H ₆) | 80 vol% or more |
| Propane (C ₃ H ₈) | 90 vol% or more |

Battery replacement

- Be sure to turn off the power for the product before replacing the batteries.
- When replacing the batteries, replace all six with new batteries at the same time.
- The following batteries must be used to ensure that the product meets explosion-proof standards.
(Applies only when using the dry battery unit)
Japan Ex model: Toshiba AA alkaline battery (LR6) ×6
ATEX/IECEx model: Toshiba AA alkaline battery (LR6) ×6 or Duracell (MN1500) ×6
- Note the polarity of the batteries.

Usage

- The operating time will be reduced due to battery performance in cold environments.
- The response of the LCD display may slow at low temperatures.
- Always perform fresh air adjustment under conditions of pressure, temperature, and humidity similar to those in the operating environment and in clean air.
- Wait for the reading to stabilize before performing fresh air adjustment.
- If there is a temperature difference of 15 °C or more between the storage and usage locations, turn on the power and allow the product to stand for about 10 minutes in a similar environment to the usage location to acclimatize before performing fresh air adjustment in clean air.
- Do not use water or organic solvents such as alcohol or benzene when wiping the product. Doing so may discolor or damage the surfaces of the product.
- Even if the product is not used for extended periods, turn the power on at least once every six months to check pump suction (by running the product for approximately three minutes). Grease inside the pump motor may solidify and prevent operation if the product is not operated for extended periods.
- After a period of extended storage, be sure to perform fresh air adjustment before resuming use. For information on readjustment including fresh air adjustment, contact RIKEN KEIKI.

- Do not use the product in locations where the following miscellaneous gases are present:

<Gases affecting sensor sensitivity>

| Sensor type | Miscellaneous gas type |
|---|---|
| NCF sensor (New ceramic type) | <ul style="list-style-type: none"> Organic silicone gases such as D4 siloxane and D5 siloxane, and sulfur gases such as SO_x and hydrogen sulfide (H₂S) at concentrations exceeding the detection range of the sensors installed together Polymer substances such as ethylene oxide (C₂H₄O), acrylonitrile (C₃H₃N), butadiene (C₄H₆), and styrene (C₈H₈) Catalyst poisons such as phosphorous compounds, halogenated hydrocarbon, and metallic vapors * The extent of the effect depends on the sensor model. |
| TEF sensor (Thermal conductivity type) | N/A |
| IRF sensor (Non-dispersive infrared type (NDIR)) | N/A |
| ESF/ESR sensor (Electrochemical type) | Differs depending on sensor. |

<Sensor-corroding gases>

| Sensor type | Miscellaneous gas type |
|---|---|
| NCF sensor (New ceramic type) | Corrosive gases such as SO _x and NO _x and acidic gases such as hydrogen fluoride (HF) and hydrogen chloride (HCl) |
| TEF sensor (Thermal conductivity type) | High-concentration organic gases and high-concentration alcohol (C ₂ H ₆ O) |
| IRF sensor (Non-dispersive infrared type (NDIR)) | Corrosive gases such as SO _x and NO _x and acidic gases such as hydrogen fluoride (HF) and hydrogen chloride (HCl) |
| ESF/ESR sensor (Electrochemical type) | N/A |

- Take care when installing the product in locations where the following interference gases are present.

| Sensor type | Miscellaneous gas type |
|---|--|
| NCF sensor (New ceramic type) | Hydrocarbons, alcohols (C ₂ H ₆ O), and organic solvents, etc., other than the target gas |
| TEF sensor (Thermal conductivity type) | Organic gases, alcohols (C ₂ H ₆ O), carbon dioxide (CO ₂), argon (Ar) |
| IRF sensor (Non-dispersive infrared type (NDIR)) | Combustible gas sensor: Hydrocarbons, alcohols (C ₂ H ₆ O), organic solvents, and water (H ₂ O), etc. other than the target gas Carbon dioxide sensor: High-concentration carbon monoxide (CO), nitrous oxide (N ₂ O), and nitrogen monoxide (NO), Hydrocarbons, etc. |
| ESF/ESR sensor (Electrochemical type) | Differs depending on sensor. |

2-4 Safety information

<Product overview>

This product is a suction-type portable gas detector. It can measure up to six different gas types. When the gas concentration exceeds the alarm point, an LCD display, LED and piezoelectric buzzer will be activated to alert.

Up to 3 R-sensors for the measurement of O₂, H₂S, and CO as well as a maximum of 3 F-sensors out of 5 to measure Combustible gases, Toxic gases, CO₂ and VOC can be mounted.

F-sensor will internally process as far as concentration calculation, and transmit digital data for gas concentration to the main CPU.

Sampling of gas is done by the pump installed within the device. The GX-9000 has one built-in pump to perform simultaneous measurement using all sensors installed in the product. The GX-9000H is internally divided into two systems to manually switch between two pumps depending on the target gas.

<Power source>

- Either lithium-ion battery unit "BUL-9000" or alkaline battery unit "BUD-9000" can be installed into GX-9000.
- BUL-9000 is specified for chargeable lithium-ion batteries. Uses three Panasonic NCR18650GA batteries arranged in parallel.
- BUD-9000 is specified to use dry batteries. Japan Ex models can use six LR6 batteries manufactured by Toshiba. ATEX/IECEx models can use either six LR6 batteries manufactured by Toshiba or six MN1500 batteries manufactured by Duracell. Six batteries are used with two sets of three arranged in parallel.
- Since these 2 kinds of batteries differ in the increase of temperature when shorted, their temperature ranges and classes also differ.
- Structure of battery unit allows end users to replace batteries by themselves.
- The battery should be charged with the dedicated AC adapter or by power from IEC60950-certified SELV power source, or IEC62368-1-certified ES1 power source. The maximum voltage from the charger shall not exceed 5.7 Vdc.
- It is also possible to perform USB data communication with a PC that meets the above requirements.
- Batteries should only be charged and replaced in non-hazardous locations.
- Backup battery type CR1220 manufactured by Maxell.

<Japan Ex models>

Ex code

| | |
|------------------------------------|--|
| Main unit: | Ex da ia IIC T4 Ga (with combustible gas sensor NCF-6322) Ex ia IIC T4 Ga (without combustible gas sensor NCF-6322) |
| BUL-9000 lithium ion battery unit: | Ex ia IIC T4 Ga |
| BUD-9000 dry battery unit: | Ex ia IIC T4 Ga |

Explosion-proofing guideline compliance

| | |
|------------------------------------|---|
| Main unit: | JNIOSH-TR-46-1:2020 JNIOSH-TR-46-2:2018 JNIOSH-TR-46-6:2015 |
| BUL-9000 lithium ion battery unit: | JNIOSH-TR-46-1:2020 JNIOSH-TR-46-6:2015 |
| BUD-9000 dry battery unit: | JNIOSH-TR-46-1:2020 JNIOSH-TR-46-6:2015 |

Battery unit ratings

BUL-9000 lithium ion battery unit:

Power supply: 3.7 V DC, 250 mA

BUD-9000 dry battery unit:









Power supply: 4.5 V DC, 250 mA (Toshiba LR6 batteries × 6)

Ambient temperature

Ambient temperature*: -40 °C to +60 °C

* Ambient temperature refers to the temperature range in which the explosion-proof performance can be maintained. It does not refer to the temperature range in which product performance is guaranteed. For information on the operating temperature range, refer to '11-1 Product specifications' and '11-2 Sensor specifications'.

<ATEX/IECEx models>

| Ex code | Ambient temperature | NC-6322* | Battery type |
|---|----------------------|----------|-------------------------------|
| Ex da ia IIC T4 Ga | -40 °C ≤ Ta ≤ +60 °C | YES | BUL-9000 |
|  II 1 G Ex da ia IIC T4 Ga | | | |
| Ex ia IIC T4 Ga | -40 °C ≤ Ta ≤ +60 °C | NO | BUL-9000 |
|  II 1 G Ex ia IIC T4 Ga | | | |
| Ex da ia IIC T4 Ga | -40 °C ≤ Ta ≤ +60 °C | YES | BUD-9000 LR6 (Toshiba) |
|  II 1 G Ex da ia IIC T4 Ga | | | |
| Ex ia IIC T4 Ga | -40 °C ≤ Ta ≤ +60 °C | NO | BUD-9000 LR6 (Toshiba) |
|  II 1 G Ex ia IIC T4 Ga | | | |
| Ex da ia IIC T4 Ga | -40 °C ≤ Ta ≤ +40 °C | YES | BUD-9000 MN1500 (Duracell) |
|  II 1 G Ex da ia IIC T4 Ga | | | |
| Ex ia IIC T4 Ga | -40 °C ≤ Ta ≤ +40 °C | NO | BUD-9000 MN1500 (Duracell) |
|  II 1 G Ex ia IIC T4 Ga | | | |
| Ex da ia IIC T3 Ga | -40 °C ≤ Ta ≤ +60 °C | YES | BUD-9000 MN1500 (Duracell) |
|  II 1 G Ex da ia IIC T3 Ga | | | |
| Ex ia IIC T3 Ga | -40 °C ≤ Ta ≤ +60 °C | NO | BUD-9000 MN1500 (Duracell) |
|  II 1 G Ex ia IIC T3 Ga | | | |

* NC-6322 is a new ceramic type sensor that makes up the NCF-6322P / NCF-6322P M.

Certificate numbers

- IECEx : IECEx DEK 21.0057X
- ATEX : DEKRA 21 ATEX 0089X

Applicable standards

- IEC 60079-0:2017
- IEC 60079-1:2014-06
- IEC 60079-11:2011
- EN IEC 60079-0:2018
- EN 60079-1:2014
- EN 60079-11:2012



WARNING

For GX-9000 / GX-9000H

- Do not attempt to disassemble or modify the instrument.
- The combustible gas sensor (NC-6322) measures %LEL. It is installed only on products with flame-proof construction.
- The product is explosion-proof. With the exception of specified components, it cannot be disassembled or modified.
- NC-6322 must not be exposed to ultraviolet light.
- This product integrates a sensor having flameproof construction. If assembly is not performed as specified, explosion protection performance will be compromised. When replacing the sensor and filter, properly install genuine parts and torque to specification.
- If the enclosure is damaged it shall be repaired before further use.
- The Sensor shall not be exposed to ultraviolet light or used in equipment in which it is not fully enclosed.

For GX-9000 / GX-9000H with BUL-9000

- Do not charge in a hazardous location.
- Do not charge the unit with a non-genuine charger.
- Do not replace battery unit in a hazardous location.
- When connecting to a PC via USB, the PC must be connected using an IEC 60950-certified SELV power source, or IEC 62368-1-certified ES1 power source. The maximum voltage from the PC shall not exceed 5.7 Vdc.

For GX-9000 / GX-9000H with BUD-9000

- Do not replace battery unit in a hazardous location.
- Do not replace dry batteries in a hazardous location.
- With Japan Ex models, always use alkaline AA batteries (type LR6 manufactured by Toshiba). With ATEX/IECEx models, always use alkaline AA batteries (type LR6 manufactured by Toshiba or type MN1500 manufactured by Duracell).
- When connecting to a PC via USB, the PC must be connected to IEC 60950-certified SELV power source, or IEC 62368-1-certified ES1 power source. The maximum voltage from the PC shall not exceed 5.7 Vdc.

Product code

INST. No. 0 0 000 0000 00
 A B C D E

A: Year of manufacture (0 to 9)

B: Month of manufacture (1 to 9 for Jan. to Sep.; XYZ for Oct., Nov., Dec.)

C: Manufacturing lot

D: Serial number

E: Factory codes



RIKEN KEIKI Co.,Ltd.

2-7-6 Azusawa, Itabashi-ku, Tokyo, 174-8744, Japan

Phone: +81-3-3966-1113

Fax: +81-3-3558-9110

E-mail: intdept@rikenkeiki.co.jp

Website: <https://www.rikenkeiki.co.jp/english/>

3

Product Configuration

3-1 Main unit and accessories

Open the box and packaging and inspect the main unit and accessories.
If any accessories or parts are missing, contact RIKEN KEIKI.

3-1-1 Main unit

For detailed information on the names and functions of product parts and the LCD display, refer to '3-2 Part names and functions'.

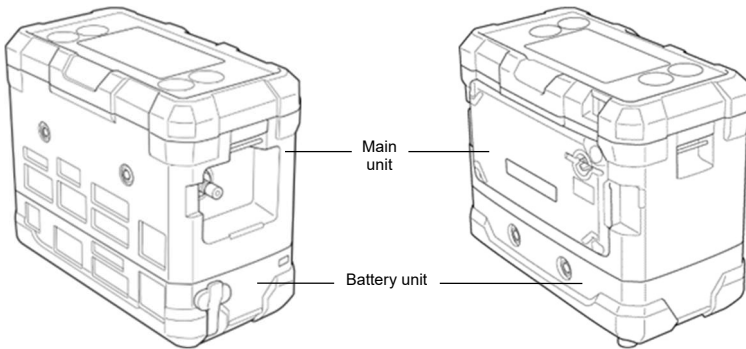

<GX-9000>



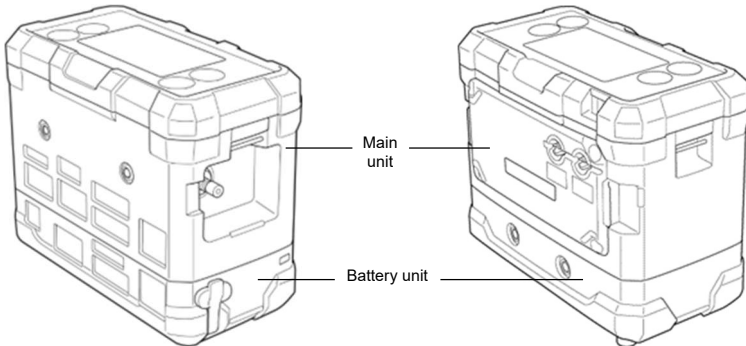

<GX-9000H>

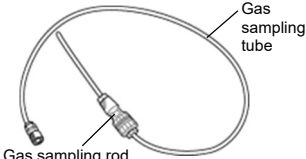
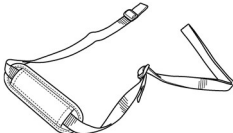
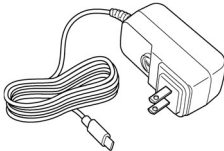
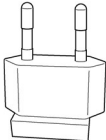
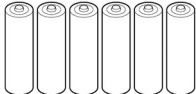
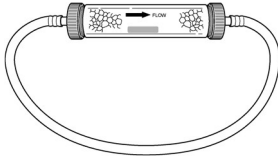

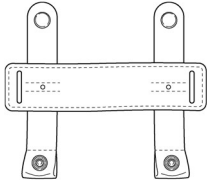



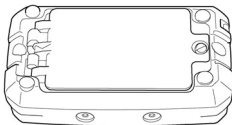
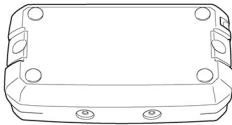
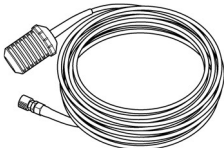
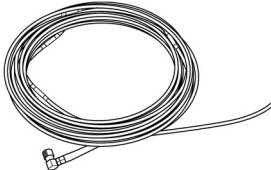

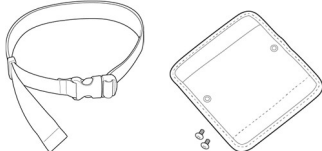

3-1-2 Accessories

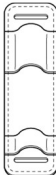
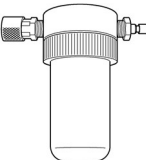
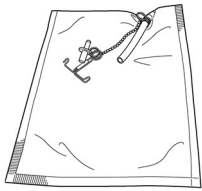

| Part name | | Remarks |
|--|--|---|
|  <p>Gas sampling tube</p> <p>Gas sampling rod</p> | <p>Gas sampling rod/ gas sampling tube (approx. 75 cm)</p> | <p>Part Nos.: 0904 0275 00 (Gas sampling rod) 0914 0135 30 (Gas sampling tube)</p> |
|  | <p>Shoulder strap</p> | <p>Part No.: 4777 4592 10</p> |
|  | <p>AC adapter</p> | <p>Provided with lithium ion battery unit (BUL-9000) Part No.: 2594 1342 30</p> |
|  | <p>Adapter plug (EU/Type C)</p> | <p>Provided with lithium ion battery unit (BUL-9000) of ATEX/IECEx model Part No.: 2594 1435 00</p> |
|  | <p>AA alkaline batteries (×6)</p> | <p>Provided with dry battery unit (BUD-9000) Part No.: 2753 3007 80</p> |
|  | <p>CO₂ removal filter CF-284</p> | <p>Provided when carbon dioxide sensor is installed Used for CO₂ zero adjustment Part No.: 4383 0390 80</p> |
|  | <p>Activated carbon filter CF-8350</p> | <p>Provided when VOC sensor is installed Used for fresh air adjustment Part No.: 4383 9299 50</p> |
|  | <p>Filter cylinder retaining belt for shoulder strap</p> | <p>Provided with CO₂ removal filter CF-284 and activated carbon filter CF-8350 Allows attachment of the filter above to the shoulder strap. Part No.: 4777 4572 20</p> |

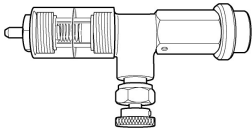
3-1-3 Optional accessories

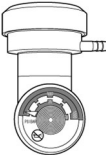
| Part name | | Remarks |
|--|---|---|
|  | Dry battery unit (BUD-9000) | Either the dry battery unit or lithium ion battery is provided, but additional units can be purchased separately. Part No. (BUD-9000): 4777 9603 60 (Japan Ex model) 4777 9605 10 (ATEX/IECEx model) |
|  | Lithium ion battery unit (BUL-9000) | Part No. (BUL-9000): 4777 9602 90 (Japan Ex model) 4777 9604 30 (ATEX/IECEx model) |
|  | Sampling tube with float (8 m/30 m/45 m) | The waterproof filter inside the float separates water to allow gas detection. Part No.: 4384 0430 60 (8 m tube) Part No.: 4775 9678 80 (30 m tube) Part No.: 4777 9567 60 (45 m tube) |
|  | Sampling tube with weight (30 m/45 m) | Includes a weight on the end to make it easier to lower the tube. Part No.: 4775 9679 50 (30 m tube) Part No.: 4777 9465 80 (45 m tube) |
|  | Absorbent cotton filter CF-8385/ Connecting tube | Tube for connecting the waterproof filter to the gas detector. This is recommended for dusty environments, as the IRF sensor is susceptible to the effects of dust. Due to the risk of adsorption, avoid use when the ESF sensor (except for H ₂ S (high concentrations)) or VOC sensor is installed. Part Nos.: 4383 0850 00 (CF-8385) 4775 9617 60 (Connecting tube) 1879 0011 10 (Replacement absorbent cotton) |
| — | Filter unit (CF-A13i) Set of 5 | Internal interference gas removal filter used with the hydrogen sulfide sensor (ESR-A13i) Part No.: 4777 9317 30 |
| — | Filter unit (CF-A1CP) Set of 5 | Internal interference gas removal filter used with the carbon monoxide sensor (ESR-A13P) Part No.: 4777 9316 60 |

| Part name | Remarks | |
|---|--------------------------------------|---|
|  | Filter cylinder retaining belt | Used to attach CF-8385 absorbent cotton filter to the gas detector Part No.: 4777 9444 20 |
|  | Waist belt/ Waist belt attachment | Allows the gas detector to be worn at the waist. Use with the shoulder strap is recommended to avoid dropping the gas detector. Part Nos.: 4775 5653 40 (Waist belt) 4775 9853 10 (Waist belt attachment) |
|  | Leather case | Protects the main unit against dirt. Also allows attachment of the shoulder strap, waist belt, and absorbent cotton filter. Part No.: 4777 4593 80 |
|  | Sampling rod holder | Attached to the shoulder strap; allows storage of the gas sampling rod tip. Part No.: 4775 5651 00 |
|  | Water trap | Connects between the sampling tube and gas detector to eliminate any water. Part No.: 0904 0186 20 |
|  | Gas sampling bag | Part Nos.: 0904 0103 80 (1 L (green)) 0904 0104 50 (1 L (orange)) 0904 0288 10 (2 L (black)) |

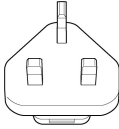
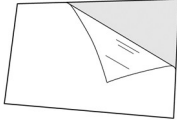
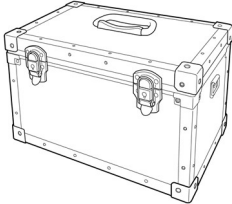
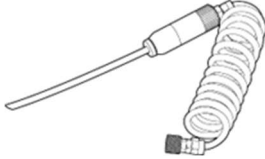
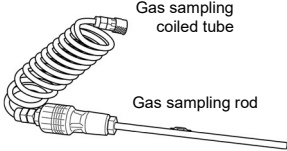
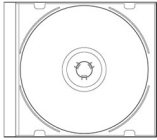
| Part name | | Remarks |
|---|--|--|
|  | Calibration gas can (Content: 5 L/ can volume: 0.6 L) | Part Nos.: 1875 9110 70 (Nitrogen (N ₂): 99.99 vol% or greater) 1875 9056 30 (Methane (CH ₄): 50 %LEL, air balance) 1875 9107 90 (Isobutane (HC (i-C ₄ H ₁₀)): 50 %LEL, air balance) 1875 9104 70 (Isobutane (HC (i-C ₄ H ₁₀)): 10 vol%, N ₂ balance) 1875 9143 60 (Methane (CH ₄): 50 vol%, N ₂ balance) 1875 9058 80 (Methane (CH ₄): 70 %LEL, N ₂ balance) 1875 9057 10 (Methane (CH ₄): 70 vol%, N ₂ balance) 1875 9065 50 (Carbon monoxide (CO): 145 ± 5 ppm, N ₂ balance) 1875 9076 10 (Carbon dioxide (CO ₂): 10 vol%, N ₂ balance) |
|  | Flow indicator with needle valve | Used to extract gas from the calibration gas can Part No.: 1621 1901 70 |
|  | Gas cylinder (Content: 34 L, approx. 270 (H) x 79.3 (W) mm) | Part Nos.: 9650 3209 90 (Hydrogen sulfide (H ₂ S): 25 ppm, carbon monoxide (CO): 50 ppm, methane (CH ₄): 50 %LEL, oxygen (O ₂): 12 vol%) 9650 3213 40 (Hydrogen sulfide (H ₂ S): 25 ppm, carbon monoxide (CO): 50 ppm, isobutane (HC (i-C ₄ H ₁₀)): 50 %LEL, oxygen (O ₂): 12 vol%) |
|  | Demand flow valve/ 10 cm connection tube | Used to extract gas from the gas cylinder Part Nos.: 1641 0190 20 (Demand flow valve) 4775 5958 10 (10 cm connection tube) |
|  | Adapter plug (AU/Type O) | Part No.: 2594 1434 20 |

| Part name | | Remarks |
|---|--|---|
|  | Adapter plug (UK/Type BF) | Part No.: 2594 1436 70 |
|  | LCD protective film Set of 5 | Part No.: 4777 9025 70 |
|  | Aluminum storage case | Dimensions: Approx. 365 (W) × 236 (H) × 226 (D) mm Part No.: 4777 9579 00 * Excluding projections |
|  | Diluter | Dilutes the gas drawn in with air to a 1:1 ratio, allowing use of even new ceramic type sensors in inert gas in which they typically cannot be used. Cannot be used for high-concentration combustible gases due to the risk of explosion. Part No.: 4775 9934 30 |
|  | Gas sampling rod/ Gas sampling coiled tube (1 m) | Part Nos.: 0904 0275 00 (Gas sampling rod) 0914 0072 40 (Gas sampling coiled tube) |
|  | Data logger management program | Part Nos.: 9811 0980 90 (Japan Ex model) 9811 0990 80 (ATEX/IECEx model) |
|  | USB interface cable | Used for interfacing with the PC on which the data logger management program and setup program are installed. Part No.: 2440 2728 90 |

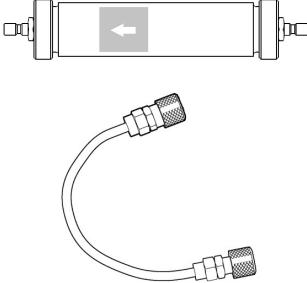
| Part name | | Remarks |
|---|---|---|
| — | Hydrogen sulfide calibration gas kit (CK-82) | Adjust using ampule. Part No.: 4395 0320 60 |
|  | With flow monitor Filter tube / Connecting tube | <p>In the case of hydrogen (H₂) type, the design is such that the operation of the pressure sensor be switched off so that a flow abnormality due to a decrease in pressure is not triggered when high concentrations of H₂ are suctioned.</p> <p>The filter tube with flow monitor of optional accessory allows you to check that suction is being provided by the product.</p> <p>Part no: 4777 9576 80 (Filter tube with flow monitor) 4775 9617 60 (Relay tube)</p> |

 **CAUTION**

- Use the sampling tube with weight in conjunction with the CF-8385 absorbent cotton filter. The CF-8385 absorbent cotton filter is used to remove dust and protect against water. When using the sampling tube with weight, the filter cylinder retaining belt and connecting tube must also be used. If water is sucked in without using the CF-8385 absorbent cotton filter, water will get inside the main unit, causing it to fail.
- If the separately sold sampling tube with float or weight is used when measuring highly adsorptive gas, the gas may be adsorbed inside the tube, resulting in a lower concentration reading than the actual concentration of the detection target gas at the measurement point.
- The CF-8385 absorbent cotton filter is recommended for dusty environments, as the IRF sensor is susceptible to the effects of dust.
- Do not use the separately sold tubes or filters when the ESF sensor (except for the ESF-A24R2 (high-concentration H₂S)) or VOC sensor is installed, due to the risk of adsorption, even when recommended above.

3-2 Part names and functions

3-2-1 Main unit and battery unit

<GX-9000/GX-9000H>

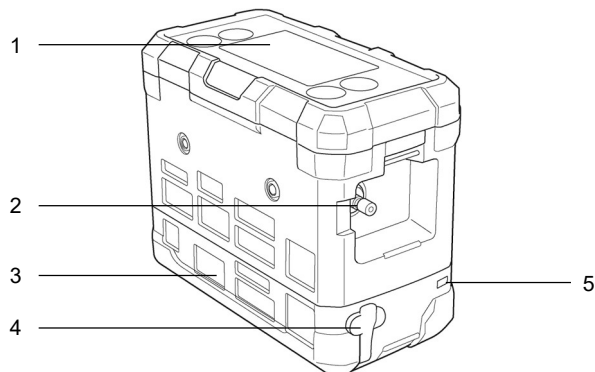

<GX-9000>

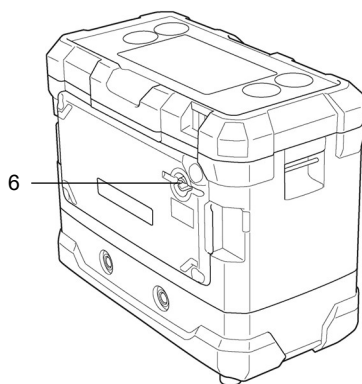

<GX-9000H>

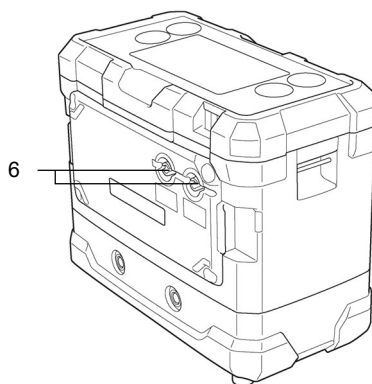

| No. | Name | Functions |
|-----|---|---|
| 1 | Control panel | Contains the buttons and LCD for operating the product. |
| 2 | Gas inlet (GAS IN) | Draws in the gas. Connect a tube and attach the provided gas sampling rod. |
| 3 | Battery unit | The lithium ion battery unit (BUL-9000) or dry battery unit (BUD-9000) that powers the product. |
| 4 | Jack cover | Cover for the AC adapter and USB cable connector Detach the cover to connect the AC adapter to charge when using the lithium ion battery unit (BUL-9000). Connect a USB cable to connect to a PC. |
| 5 | Charging indicator lamp (BUL-9000 only) | Lights up in red when charging, and lights up green when charging is complete. Lights up in orange when charging while connected to the PC. |
| 6 | Gas outlet (GAS OUT) | Discharges the gas drawn in. (Do not block.) |

**CAUTION**

- Do not prod the buzzer sound opening with sharp objects. Doing so may result in ingress of water or foreign matter, resulting in malfunctions or damage to the product.
 - Do not remove the panel sheet on the surface. Doing so will impair dustproof and waterproof performance.
 - Do not block the buzzer sound opening with tape or other objects. This will prevent adjustment of the internal pressure of the product, which may result in malfunctions.
-

3-2-2 Control panel

<GX-9000>

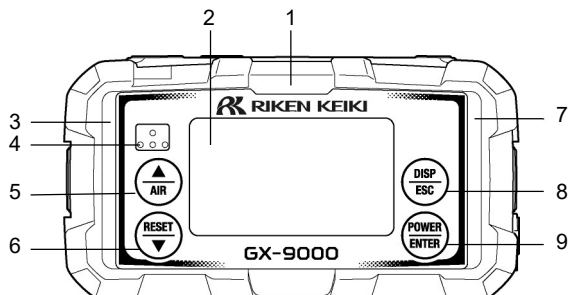

| No. | Name | Functions |
|-----|-------------------------|--|
| 1 | Alarm LED array (top) | The lamps flash red when an alarm occurs. |
| 2 | LCD display | Displays information such as gas type and gas concentration. |
| 3 | Alarm LED array (left) | The lamps flash red when an alarm occurs and measurement is not underway. |
| 4 | Buzzer sound opening | Emits operating and alarm sounds. (Do not block.) |
| 5 | ▲/AIR button | Performs fresh air adjustment in measurement mode. Used to select items and adjust numerical values (up) in display mode and user mode. |
| 6 | RESET/▼ button | Turns the pump on and off in measurement mode. Also resets alarms. Used to select items and adjust numerical values (down) in display mode and user mode. |
| 7 | Alarm LED array (right) | The lamps flash red when an alarm occurs and measurement is not underway (when power is turned on and in user mode). |
| 8 | DISP/ESC button | Selects display mode. Selects display items in display mode. |
| 9 | POWER/ENTER button | Turns the power on and off. Used in user mode to confirm values or make settings. |

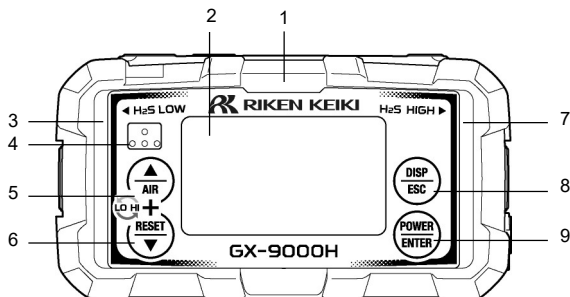
<GX-9000H>

| No. | Name | Functions |
|-----|--|--|
| 1 | Alarm LED array | The lamps flash red when an alarm occurs. |
| 2 | LCD display | Displays information such as gas type and gas concentration. |
| 3 | H ₂ S low concentration measurement mode selection indicator lamps | The lamps light up green when H ₂ S low concentration measurement mode is selected. |
| | Alarm LED array (left) | The lamps flash red when an alarm occurs and measurement is not underway. |
| 4 | Buzzer sound opening | Emits operating and alarm sounds. (Do not block.) |
| 5 | ▲/AIR button | Performs fresh air adjustment in measurement mode. Used to select items and adjust numerical values (up) in display mode and user mode. Press the ▲/AIR and RESET/▼ buttons simultaneously to toggle between H ₂ S high concentration measurement mode and H ₂ S low concentration measurement mode. |
| 6 | RESET/▼ button | Turns the pump on and off in measurement mode. Also resets alarms. Used to select items and adjust numerical values (down) in display mode and user mode. |
| 7 | H ₂ S high concentration measurement mode selection indicator lamps | The lamps light up green when H ₂ S high concentration measurement mode is selected. |
| | Alarm LED array (right) | The lamps flash red when an alarm occurs and measurement is not underway (when power is turned on and in user mode). |
| 8 | DISP/ESC button | Selects display mode. Selects the display in display mode. |
| 9 | POWER/ENTER button | Turns the power on and off. Used in user mode to confirm values or make settings. |

3-2-3 LCD display

<GX-9000>

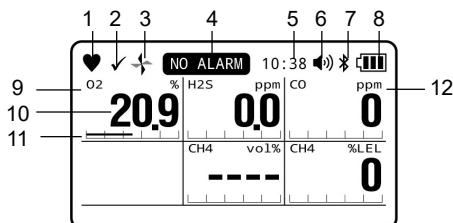

<GX-9000H>

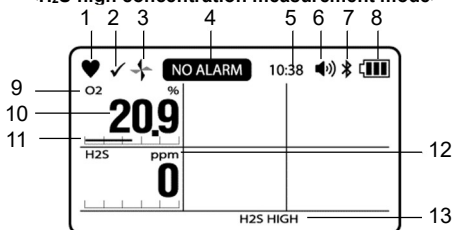
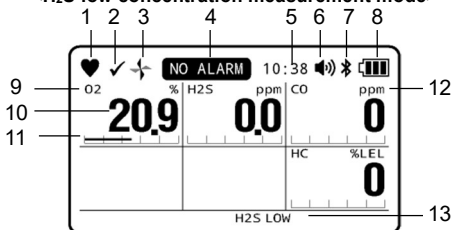
<H₂S high concentration measurement mode><H₂S low concentration measurement mode>

| No. | Name | Functions |
|-----|--|--|
| 1 | Operating status icon | Indicates the operating status in measurement mode. Blinks when normal. |
| 2 | Bump test expiration icon | Displayed until the bump test expiration date when the bump test expiration display setting is enabled. |
| 3 | Flow confirmation icon | Indicates the gas suction status in measurement mode. The icon rotates when normal. |
| 4 | Gas alarm function off display | Displayed when the gas alarm function is turned off. Alarms will not operate when the gas alarm function is turned off. |
| 5 | Clock display | Displays the current time. |
| 6 | Buzzer volume icon | Indicates the buzzer volume. |
| 7 | Bluetooth icon | Displayed when the Bluetooth function is turned on. |
| 8 | Battery level icon | Indicates battery levels. |
| 9 | Gas name display | Displays the target gas names. The gas names displayed will vary depending on the sensors installed. |
| 10 | Gas concentration display | Displays the measured gas concentration. |
| 11 | Gas concentration bar display | The (full scale) measurement range is segmented to indicate gas concentrations as bars. It indicates concentrations as ratios of the full scale. |
| 12 | Units display | Displays units (ppm, ppb, vol%, %, %LEL) according to the sensor specifications. |
| 13 | H ₂ S measurement mode display (GX-9000H) | Displays the H ₂ S measurement mode during measurement. [H2S HIGH] is displayed for H ₂ S high concentration measurement mode. [H2S LOW] is displayed for H ₂ S low concentration measurement mode. |

NOTE

- ▶ Approximate battery levels are indicated as follows:

 : Sufficient

 : Low

 : Needs charging (replace the batteries).

The battery level icon will blink if the battery level drops even further. The LEDs and buzzer operate every four seconds to alert the user.

- ▶ The buzzer volume icon indicates as follows:

 : High volume

 : Low volume

- ▶ When both NCF and TEF sensors are installed, concentrations are displayed for only one of the sensors (which sensor depends on factors such as the detected concentrations). [----] or [OFF] will be displayed on the concentration display for the sensor for which concentrations are not displayed. (Refer to '6-4-1 Setting the NCF/TEF sensor range'.)
-

4

Alarm Functions

4-1 Gas alarm types

A gas alarm is triggered instantaneously when the concentration of the measured gas reaches or exceeds the alarm setpoints shown in the following table. (Self-latching)

Gas alarm types include the first alarm (WARNING), second alarm (ALARM), TWA alarm, STEL alarm, OVER alarm (over scale), and M OVER alarm (negative sensor failure).

Gas alarms are prioritized as follows:

First alarm < second alarm < M OVER alarm < OVER alarm < TWA alarm < STEL alarm

4-2 Gas alarm setpoints

The default settings for gas alarm setpoints are as shown in the following table:

<Combustible gas (New ceramic type sensor)>

| Item | Detection target gas | Methane CH ₄ | Methane CH ₄ |
|--------------------------------|----------------------|-------------------------|-------------------------|
| Sensor model | | NCF-6322P | NCF-6322P M |
| Explosion-proof specifications | | Japan Ex | ATEX/IECEX |
| Display range | | 0 – 100 %LEL | 0 – 100 %LEL |
| Detection range | | 0 – 100 %LEL | 0 – 100 %LEL |
| Resolution | | 1 %LEL | 1 %LEL |
| Alarm setpoints | First alarm | 10 %LEL | 10 %LEL |
| | Second alarm | 50 %LEL | 50 %LEL |
| | TWA | - | - |
| | STEL | - | - |
| | OVER | 100 %LEL | 100 %LEL |
| | M OVER | -10 %LEL | -10 %LEL |

| Item | Detection target gas | Isobutane HC (i-C ₄ H ₁₀) | Hydrogen H ₂ | Acetylene C ₂ H ₂ |
|--------------------------------|----------------------|--|-------------------------|---|
| Sensor model | | NCF-6322P | | |
| Explosion-proof specifications | | Japan Ex and ATEX/IECEx | | |
| Display range | | 0 – 100 %LEL | 0 – 100 %LEL | 0 – 100 %LEL |
| Detection range | | 0 – 100 %LEL | 0 – 100 %LEL | 0 – 100 %LEL |
| Resolution | | 1 %LEL | 1 %LEL | 1 %LEL |
| Alarm setpoints | First alarm | 10 %LEL | 10 %LEL | 10 %LEL |
| | Second alarm | 50 %LEL | 50 %LEL | 50 %LEL |
| | TWA | - | - | - |
| | STEL | - | - | - |
| | OVER | 100 %LEL | 100 %LEL | 100 %LEL |
| | M OVER | -10 %LEL | -10 %LEL | -10 %LEL |

<Combustible gas (Thermal conductivity type sensor)>

| Item | Detection target gas | Methane CH ₄ | Isobutane HC (i-C ₄ H ₁₀) | Hydrogen H ₂ |
|--------------------------------|----------------------|-------------------------|--|-------------------------|
| Sensor model | | TEF-7520P | | |
| Explosion-proof specifications | | Japan Ex and ATEX/IECEx | | |
| Display range | | 0 – 100.0 vol% | 0 – 100.0 vol% | 0 – 100.0 vol% |
| Detection range | | 0 – 100.0 vol% | 0 – 100.0 vol% | 0 – 100.0 vol% |
| Resolution | | 0.1 vol% | 0.1 vol% | 0.1 vol% |
| Alarm setpoints | First alarm | 25.0 vol% | 25.0 vol% | 25.0 vol% |
| | Second alarm | 50.0 vol% | 50.0 vol% | 50.0 vol% |
| | TWA | - | - | - |
| | STEL | - | - | - |
| | OVER | 100.0 vol% | 100.0 vol% | 100.0 vol% |
| | M OVER | -10.0 vol% | -10.0 vol% | -10.0 vol% |

<Combustible gas (Non-dispersive infrared type sensors)>

| Item | Detection target gas | Methane CH ₄ | Isobutane HC (i-C ₄ H ₁₀) |
|--------------------------------|----------------------|--|--|
| Sensor model | | IRF-4341 | IRF-4345 |
| Explosion-proof specifications | | Japan Ex and ATEX/IECEx | |
| Display range | | 0 – 100.0 %LEL/ 100.0 %LEL – 100.0 vol% | 0 – 100.0 %LEL/ 100.0 %LEL – 100.0 vol% |
| Detection range | | 0 – 100.0 %LEL/ 100.0 %LEL – 100.0 vol% | 0 – 100.0 %LEL/ 100.0 %LEL – 100.0 vol% |
| Resolution | | 0.5 %LEL/0.1 vol% | 0.5 %LEL/0.1 vol% |
| Alarm setpoints | First alarm | 10.0 %LEL | 10.0 %LEL |
| | Second alarm | 50.0 %LEL | 50.0 %LEL |
| | TWA | - | - |
| | STEL | - | - |
| | OVER | 100.0 vol% | 100.0 vol% |
| | M OVER | -5.0 %LEL | -5.0 %LEL |

<Carbon dioxide (Non-dispersive infrared type sensor)>

| Item | Detection target gas | Carbon dioxide CO ₂ | |
|--------------------------------|----------------------|---|----------------|
| Sensor model | | IRF-4443 | IRF-4433 |
| Explosion-proof specifications | | Japan Ex and ATEX/IECEX | |
| Display range | | 0 – 20.00 vol% | 0 – 10,000 ppm |
| Detection range | | 0 – 20.00 vol% | 0 – 10,000 ppm |
| Resolution | | 0.01 vol% (0 – 5 vol%) 0.10 vol% (5 – 20 vol%) | 20 ppm |
| Alarm setpoints | First alarm | 5.00 vol% | 5,000 ppm |
| | Second alarm | 10.00 vol% | 5,000 ppm |
| | TWA | - | 5,000 ppm |
| | STEL | - | - |
| | OVER | 20.00 vol% | 10,000 ppm |
| | M OVER | -2.00 vol% | -1,000 ppm |

<Oxygen (Electrochemical type sensor)>

| Item | Detection target gas | Oxygen O ₂ | |
|--------------------------------|----------------------|--------------------------|------------|
| Sensor model | | ESR-X13P | |
| Explosion-proof specifications | | Japan Ex | ATEX/IECEX |
| Display range | | 0 – 40.0 % | 0 – 40.0 % |
| Detection range | | 0 – 25.0 % | 0 – 25.0 % |
| Resolution | | 0.1 % | 0.1 % |
| Alarm setpoints | First alarm | 18.0 % | 19.5 % |
| | Second alarm | 25.0 % | 23.5 % |
| | TWA | - | - |
| | STEL | - | - |
| | OVER | 40.0 % | 40.0 % |
| | M OVER | -1.0 % | -1.0 % |

<Hydrogen sulfide (Electrochemical type sensor)>

| Item | Detection target gas | Hydrogen sulfide H ₂ S (low concentration) | |
|--------------------------------|----------------------|--|---------------|
| Sensor model | | ESR-A13i | |
| Explosion-proof specifications | | Japan Ex | ATEX/IECEX |
| Display range | | 0 – 200.0 ppm | 0 – 200.0 ppm |
| Detection range | | 0 – 30.0 ppm | 0 – 100.0 ppm |
| Resolution | | 0.1 ppm | 0.1 ppm |
| Alarm setpoints | First alarm | 1.0 ppm | 5.0 ppm |
| | Second alarm | 10.0 ppm | 30.0 ppm |
| | TWA | 1.0 ppm | 1.0 ppm |
| | STEL | 5.0 ppm | 5.0 ppm |
| | OVER | 200.0 ppm | 200.0 ppm |
| | M OVER | -3.0 ppm | -3.0 ppm |

<Carbon monoxide (Electrochemical type sensor)>

| Item | Detection target gas | Carbon monoxide CO | |
|--------------------------------|----------------------|-----------------------|---------------|
| Sensor model | | ESR-A13P | |
| Explosion-proof specifications | | Japan Ex | ATEX/IECEX |
| Display range | | 0 – 2,000 ppm | 0 – 2,000 ppm |
| Detection range | | 0 – 500 ppm | 0 – 500 ppm |
| Resolution | | 1 ppm | 1 ppm |
| Alarm setpoints | First alarm | 25 ppm | 25 ppm |
| | Second alarm | 50 ppm | 50 ppm |
| | TWA | 25 ppm | 25 ppm |
| | STEL | 200 ppm | 200 ppm |
| | OVER | 2,000 ppm | 2,000 ppm |
| | M OVER | -50 ppm | -50 ppm |

<Hydrogen sulfide (Electrochemical type sensor)>

| Item | Detection target gas | Hydrogen sulfide H ₂ S (high concentration) | |
|--------------------------------|----------------------|---|--|
| Sensor model | | ESF-A24R2 | |
| Explosion-proof specifications | | Japan Ex and ATEX/IECEX | |
| Display range | | 0 – 1,000 ppm | |
| Detection range | | 0 – 1,000 ppm | |
| Resolution | | 1 ppm | |
| Alarm setpoints | First alarm | 1,000 ppm | |
| | Second alarm | 1,000 ppm | |
| | TWA | OFF | |
| | STEL | OFF | |
| | OVER | 1,000 ppm | |
| | M OVER | -100 ppm | |

<Toxic gas (Electrochemical type sensors)>

| Item | Detection target gas | Ammonia NH ₃ | Chlorine Cl ₂ | Ozone O ₃ |
|--------------------------------|----------------------|----------------------------|-----------------------------|-------------------------|
| Sensor model | | ESF-B242 | ESF-C930 | ESF-B249 |
| Explosion-proof specifications | | Japan Ex and ATEX/IECEx | | |
| Display range | | 0 – 75.0 ppm | 0 – 1.50 ppm | 0 – 0.600 ppm |
| Detection range | | 0 – 75.0 ppm | 0 – 1.50 ppm | 0 – 0.600 ppm |
| Resolution | | 0.5 ppm | 0.01 ppm | 0.005 ppm |
| Alarm setpoints | First alarm | 25.0 ppm | 0.50 ppm | 0.100 ppm |
| | Second alarm | 50.0 ppm | 1.00 ppm | 0.200 ppm |
| | TWA | 25.0 ppm | 0.50 ppm | 0.100 ppm |
| | STEL | 35.0 ppm | 1.00 ppm | OFF |
| | OVER | 75.0 ppm | 1.50 ppm | 0.600 ppm |
| | M OVER | -10.0 ppm | -0.15 ppm | -0.060 ppm |

| Item | Detection target gas | Hydrogen chloride HCl | Sulfur dioxide SO ₂ |
|--------------------------------|----------------------|--------------------------|-----------------------------------|
| Sensor model | | ESF-A24E2 | ESF-A24D4 |
| Explosion-proof specifications | | Japan Ex and ATEX/IECEx | |
| Display range | | 0 – 6.00 ppm | 0 – 100.0 ppm |
| Detection range | | 0 – 6.00 ppm | 0 – 100.0 ppm |
| Resolution | | 0.05 ppm | 0.1 ppm |
| Alarm setpoints | First alarm | 2.00 ppm | 2.0 ppm |
| | Second alarm | 4.00 ppm | 5.0 ppm |
| | TWA | OFF | 2.0 ppm |
| | STEL | OFF | 5.0 ppm |
| | OVER | 6.00 ppm | 100.0 ppm |
| | M OVER | -0.60 ppm | -10.0 ppm |

| Item | Detection target gas | Hydrogen cyanide HCN*1 | Hydrogen cyanide HCN*2 |
|--------------------------------|----------------------|---------------------------|---------------------------|
| Sensor model | | ESF-A24D | ESF-A24DX |
| Explosion-proof specifications | | Japan Ex | ATEX/IECEx |
| Display range | | 0 – 15.0 ppm | 0 – 15.0 ppm |
| Detection range | | 0 – 15.0 ppm | 0 – 15.0 ppm |
| Resolution | | 0.1 ppm | 0.1 ppm |
| Alarm setpoints | First alarm | 5.0 ppm | 5.0 ppm |
| | Second alarm | 10.0 ppm | 10.0 ppm |
| | TWA | OFF | OFF |
| | STEL | 4.7 ppm | 4.7 ppm |
| | OVER | 15.0 ppm | 15.0 ppm |
| | M OVER | -1.5 ppm | -1.5 ppm |

*1: Due to export restrictions, this cannot be installed in products exported outside Japan.

*2: Due to export restrictions, concentrations of 0.0 – 0.3 ppm are indicated as 0.0 ppm.

<Volatile organic compounds (Photo-ionization type (PID) sensors)>

| Item | Detection target gas | Volatile organic compounds VOCs | Volatile organic compounds VOCs | Volatile organic compounds VOCs |
|--------------------------------|----------------------|--|--|---|
| Sensor model | | PIF-001 | PIF-002 | PIF-003 |
| Photo-ionization energy | | 10.6 eV | 10.6 eV | 10.0 eV |
| Explosion-proof specifications | | Japan Ex and ATEX/IECEX | Japan Ex and ATEX/IECEX | Japan Ex and ATEX/IECEX |
| Display range | | 0 – 40,000 ppb | 0 – 4,000 ppm | 0 – 100.0 ppm |
| Detection range | | 0 – 40,000 ppb | 0 – 4,000 ppm | 0 – 100.0 ppm |
| Resolution | | 1 ppb (0 – 4,000 ppb) 10 ppb (4,000 – 40,000 ppb) | 0.1 ppm (0 – 400.0 ppm) 1 ppm (400.0 – 4,000 ppm) | 0.01 ppm (0 – 10.00 ppm) 0.1 ppm (10.00 – 100.0 ppm) |
| Alarm setpoints | First alarm | 5,000 ppb | 400.0 ppm | 5.00 ppm |
| | Second alarm | 10,000 ppb | 1,000 ppm | 10.0 ppm |
| | TWA | OFF | OFF | OFF |
| | STEL | OFF | OFF | OFF |
| | OVER | 40,000 ppb | 4,000 ppm | 100.0 ppm |
| | M OVER | -50,000 ppb | -6,000 ppm | -100 ppm |

NOTE

- ▶ The alarm setpoints indicated for the first alarm (WARNING), second alarm (ALARM), TWA alarm, and STEL alarm in the table above can be changed (or disabled). However, the setpoint cannot be changed for those shown as “-”. (Refer to ‘7-3-1 Setting alarm setpoints’.)
- ▶ The M OVER alarm (negative sensor failure) occurs when the zero point drifts to the negative side.
- ▶ Gas concentrations are checked at one-second intervals to determine whether to issue an alarm.

4-3 Gas alarm patterns

<Gas alarm buzzer sounding and lamp flashing patterns>

If a gas alarm occurs, the user is notified by the buzzer sounding and the alarm LED array flashing.
The behavior differs depending on the type of alarm.

| Alarm type | First alarm | Second alarm | TWA alarm | STEL alarm | OVER alarm | M OVER alarm |
|--------------------------|--|--|--|--|--|---|
| Buzzer sounding | Repeated alternating strong and weak beeps at about 1-second intervals "Beep, beep" | Repeated alternating strong and weak beeps at about 0.5-second intervals "Beep, beep, beep, beep" | Repeated alternating strong and weak beeps at about 1-second intervals "Beep, beep" | Repeated alternating strong and weak beeps at about 1-second intervals "Beep, beep" | Repeated alternating strong and weak beeps at about 0.5-second intervals "Beep, beep, beep, beep" | Repeated intermittent beeps at about 1-second intervals "Beep, beep" |
| Alarm LED array flashing | Repeated flashing at about 1-second intervals | Repeated flashing at about 0.5-second intervals | Repeated flashing at about 1-second intervals | Repeated flashing at about 1-second intervals | Repeated flashing at about 0.5-second intervals | Repeated flashing at about 1-second intervals |

<Alarm pattern (H-HH)>

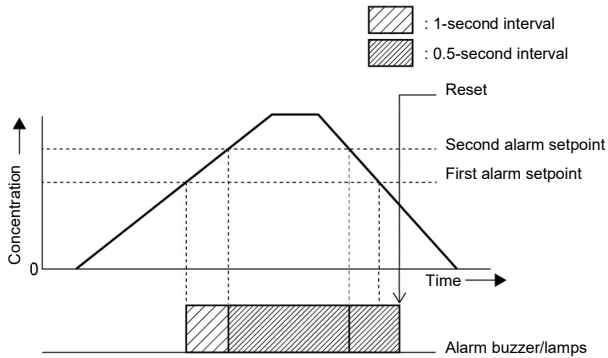

<Alarm pattern (L-LL)>

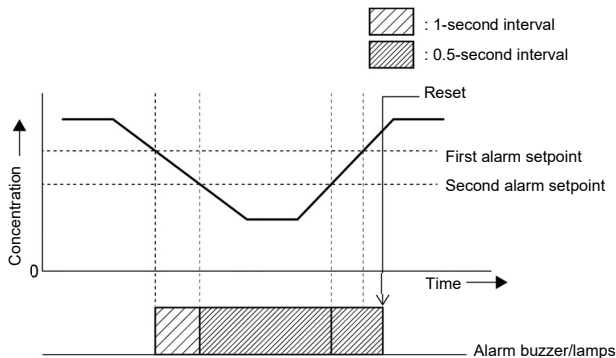

<Alarm pattern (L-H) (oxygen deficiency alarm)>

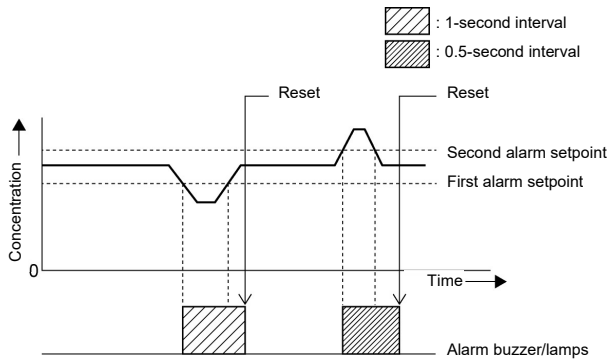

<Gas alarm display>

When a gas alarm occurs, the alarm type is indicated in the units display area of the LCD display, and the corresponding gas concentration display blinks.

If the measurement range is exceeded (over scale), [OVER] appears alternately in the units display area, and [OVER] blinks in the gas concentration display area.

<Display example ([CH4]: First alarm triggered)>

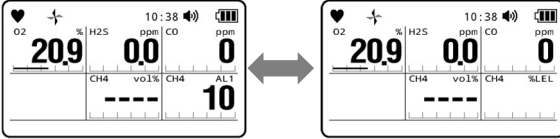

<Display example ([CH4]: Over scale)>

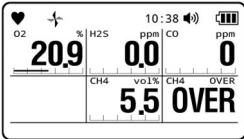

| Alarm type | First alarm | Second alarm | TWA alarm | STEL alarm | OVER alarm | M OVER alarm |
|---|-------------|--------------|-----------|------------|-----------------|------------------|
| Units display area indication | AL1 | AL2 | TWA | STEL | OVER | M OVER |
| Gas concentration display area indication | Blinking | Blinking | Blinking | Blinking | Blinking [OVER] | Blinking [-OVER] |

 **WARNING**

- A gas alarm indicates the presence of extreme danger. The user must take appropriate action after taking appropriate steps to ensure safety.

NOTE

- ▶ The alarm pattern can be checked by performing an alarm test at the alarm setpoint display in display mode. Note, however, that the gas concentration display will not blink in alarm tests. (Refer to '8-4 Performing alarm tests'.)
- ▶ If self-latching is selected, the alarm is reset when the RESET/▼ button is pressed after the gas concentration has returned to normal.
If auto reset is selected, the alarm is reset automatically once the gas concentration has returned to normal.

4-4 Fault alarm patterns

A fault alarm is triggered if an abnormality is detected in the product. (Self-latching)

Fault alarm types include system, battery voltage, clock, sensor, and flow rate abnormalities.

If a fault alarm occurs, the user is notified by the buzzer sounding and alarm LED array flashing.

- Buzzer sounding: Repeated intermittent beeps at about 1-second intervals (“Beep-beep, beep-beep”)
- Alarm LED array flashing: Repeated flashing at about 1-second intervals

The following shows fault alarm display examples:

<System abnormality>

<Clock abnormality>

<Battery voltage abnormality>

<Flow rate abnormality>

<Sensor abnormality>

CAUTION

- If a fault alarm occurs, determine the cause and take appropriate action.
If the problem lies with the product and the fault occurs repeatedly, contact RIKEN KEIKI immediately.

NOTE

- ▶ For more information on malfunctions (error messages), refer to ‘10 Troubleshooting’.
- ▶ Press the RESET/▼ button to reset the alarm.

4-5 Outside operating temperature range warning

An outside operating temperature range warning occurs in the form of a temperature range error if the product is used outside the continuous use environment operating temperature range (below -20 °C or above 50 °C) for more than 20 minutes.

When a temperature range error occurs, either leave the product for 10 minutes or longer in the operating temperature range, or turn off the power for the main unit.

If an outside operating temperature range warning occurs, the user is notified by the buzzer sounding and alarm lamp flashing.

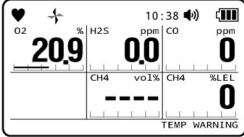
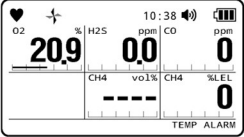
| Alarm type | Outside operating temperature range warning | |
|-------------|---|---|
| | Less than one hour outside range | One hour or more outside range |
| Buzzer | Repeated intermittent beeps at about 5-second intervals: "Beep" | |
| Alarm lamps | Repeated flashing at about 5-second intervals | |
| LCD display |  |  |
| Reset | Press the RESET/▼ button. However, the alarm will trigger automatically every 20 minutes even after the reset. | Cannot be reset. |

NOTE

- ▶ The outside operating temperature range warning occurs in measurement mode and display mode.

5

Usage Instructions

5-1 Usage note

Observe all usage precautions when using the product.

Ignoring these precautions may damage the product and prevent inaccurate gas concentration measurement.

Check the following before starting gas concentration measurement:

- Confirm that the battery level is sufficient.
- Check to confirm that the gas sampling tube and connecting tube are not bent or damaged.
- Check to confirm that the filter inside the gas sampling rod is not contaminated or clogged.
- Check to confirm that the gas sampling rod and gas sampling tube are correctly connected to the main unit.

NOTE

- ▶ If the settings for the product have been altered from an external device, be sure to confirm that the settings have been altered correctly.
- ▶ Protective film is attached to the LCD display on the product to protect it against scratching during shipping.

Be sure to peel off this protective film before using the product. Explosion-proofing cannot be guaranteed if the protective film is left attached.

5-2 Removing and attaching the battery unit and charging

5-2-1 Removing and attaching the battery unit

Follow the procedure described below to remove and attach the lithium ion battery unit (BUL-9000) or dry battery unit (BUD-9000).

 **DANGER**

- The battery unit must be removed and attached only in a safe place.

 **CAUTION**

- Be sure to turn off the power for the product before removing or attaching the battery unit.
- Do not touch the main unit connection terminals on the battery unit with bare hands. There is a risk of contact failure due to contamination or damage to internal components due to static electricity.
- Do not short-circuit the connection terminals with metal objects. The battery will overheat or the battery level will drop sharply.
- If the battery unit retaining screws are not fully tightened, the battery unit may fall off or water may get in through the gaps. Water may also get in if minute foreign matter is trapped between the battery unit and the main unit.
- Avoid damaging the rubber seal. To maintain dustproof and waterproof performance, we recommend replacing the rubber seal every two years, regardless of condition.

NOTE

- ▶ The date and time setting may be reset if the battery unit is removed for extended periods.

1 Loosen the two battery unit retaining screws on the underside of the battery unit.

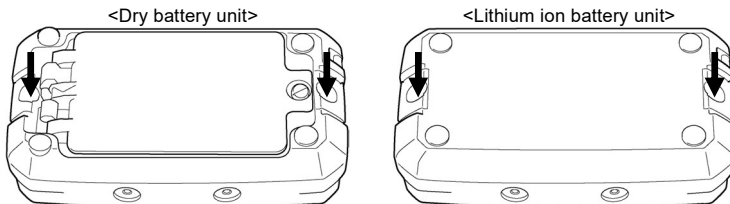

2 Remove the battery unit.

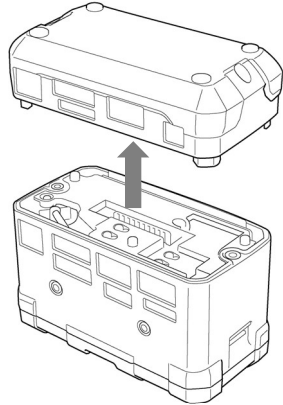

* The diagram shows the lithium ion battery unit.

3 Attach a new battery unit.

Note the connection terminals and protrusions to ensure that the battery unit is attached in the correct orientation.

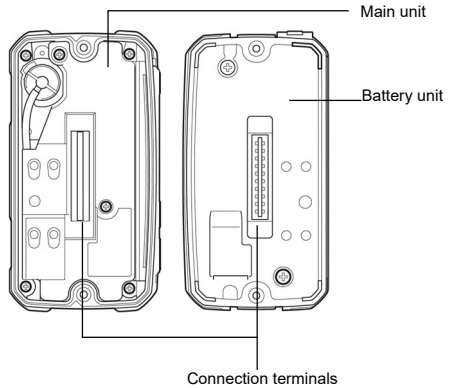

4 Tighten the two battery unit retaining screws on the underside of the main unit.

5-2-2 Charging the lithium ion battery unit (BUL-9000)

When using the product for the first time or if the battery level is low, be sure to charge the lithium battery unit using the dedicated AC adapter.



DANGER

- Charge the lithium ion battery unit only in a safe place.
- Be sure to use the dedicated AC adapter for charging.
- Charge the battery at an ambient temperature between 0 °C and +40 °C.



CAUTION

- Do not use the product while charging. Doing so will prevent correct measurement. This will also hasten battery degradation and reduce battery life.
- The AC adapter is neither waterproof nor dustproof. Do not charge the battery while the main unit is wet.
- The AC adapter is not explosion-proof.
- Do not pull the jack cover with excessive force. Doing so may damage the jack cover.
- Do not use the product with the jack cover removed. Doing so may result in ingress of dust or water and result in malfunctions. If the jack cover is damaged, replace with a new one.
- If the jack cover is not securely fitted, water may get inside. Water may also get in if minute foreign matter is trapped beneath the jack cover and the product.
- Always unplug the AC adapter from the power outlet when not in use.

NOTE

- ▶ The lithium ion battery unit may get hot during charging. This is not an abnormality.
- ▶ Wait at least 10 minutes before use. The main unit will be hot immediately after charging. Using the lithium ion battery while it is still hot may prevent correct measurement.
- ▶ The battery cannot be recharged when fully charged.

1 Open the jack cover on the lithium ion battery unit.

2 Insert the AC adapter connection terminal into the charging jack on the lithium ion battery unit.

3 Plug the AC adapter power plug into the power outlet.

The charging indicator lamp lights up in green when the AC adapter is connected. Charging begins after approximately three seconds, and the lamp lights up in red. (Full charge requires approximately eight hours at maximum.)

Once charging is completed, the charging indicator lamp lights up in green.

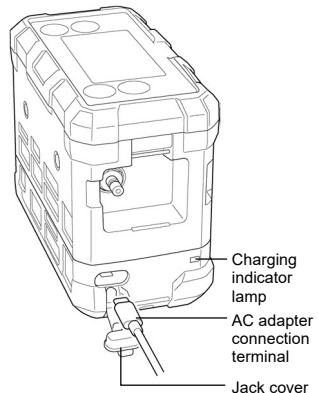

- 4 **When charging is complete, unplug the AC adapter from the power outlet.**

- 5 **Remove the AC adapter connection terminal from the lithium ion battery unit charging jack, then close the jack cover.**
Make sure the jack cover is pressed in securely.

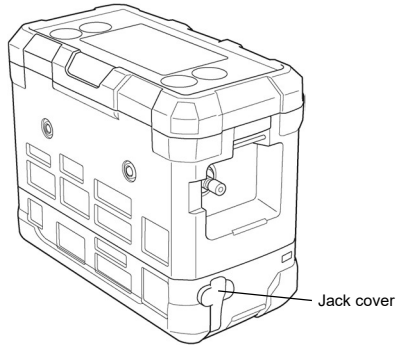

 **WARNING**

- When the product is connected to a PC via a USB cable, the charging indicator lamp lights up in green, slow charging starts after approximately 30 seconds, and the lamp lights up in orange. Slow charging is auxiliary charging to maintain communication mode. Full charging is not possible. Do not connect the product to a PC for the purpose of charging. Also, do not connect to a commercially available USB power supply.
- The AC adapter provided must be used to charge the product. Do not connect this adapter to a smartphone or other USB device.

NOTE

- ▶ Connect the product to a PC via a USB cable to use the product in communication mode. Communication mode allows you to use the separately sold SW-9000 Series data logger management program to load and use collected data on the PC.
 - ▶ When using the lithium ion battery unit, slow charging is used to ensure stable performance in communication mode.
 - ▶ Do not charge continuously in slow charging mode. Be sure to unplug the USB cable after exiting communication mode.
-

5-2-3 Replacing the dry battery unit (BUD-9000)

When using the product for the first time or if the battery level is low, replace the batteries with new alkaline AA batteries.



DANGER

- The product explosion-proof standards include the use of the specified dry batteries. When using as an explosion-proof product, use six specified alkaline AA batteries.
- Be sure to use only the specified batteries.
- Be sure to replace the batteries only in a safe place.



CAUTION

Battery replacement

- Be sure to turn off the power for the product before replacing the batteries.
- Note the polarity when inserting new batteries.
- If the battery cover retaining screw is not fully tightened, the dry batteries may fall out, or water may get in through the gaps. Water may also get in if minute foreign matter is trapped between the cover and the main unit.

Batteries

- When replacing the batteries, replace all six with new batteries at the same time.
- Do not use rechargeable batteries.

Jack cover

- Do not pull the jack cover with excessive force. Doing so may damage the jack cover.
- Do not use the product with the jack cover removed. Doing so may result in ingress of dust or water and result in malfunctions. If the jack cover is damaged, replace with a new one.
- If the jack cover is not securely fitted, water may get inside. Water may also get in if minute foreign matter is trapped beneath the jack cover and the product.

- 1 Use a flathead screwdriver or coin to loosen the battery cover retaining screw on the underside of the product.

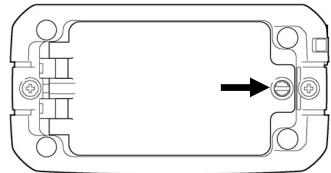

- 2 Open the battery cover.**
- 3 Insert six new AA alkaline batteries.**
Remove any old batteries inside.
Note the polarity when inserting new batteries.

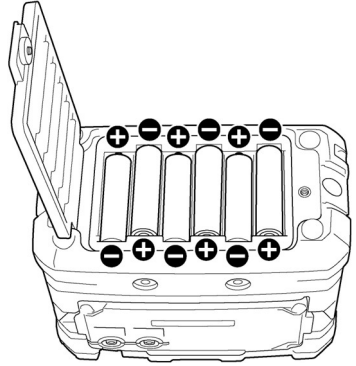

- 4 Close the battery cover, then tighten the battery cover retaining screw.**
Tighten the battery cover retaining screw securely.

5-3 Connecting the gas sampling rod

Connect the gas sampling rod to the gas inlet (GAS IN) on the main unit.
When measuring gas, connect the gas sampling rod provided to avoid the effects of airborne dust.

 **CAUTION**

- Use only the gas sampling tube specified by RIKEN KEIKI.
- Correct measurement may not be possible and the reading may be displayed lower than the actual gas concentration if the tip of the gas sampling rod is blocked or the sampling tube is bent.
When using the gas sampling rod, check to confirm that it is free of obstructions and that it is not bent.
- Use the gas sampling tube with the gas sampling rod connected to prevent foreign matter from being sucked in. If foreign matter is sucked in, replace the dust filter on the gas sampling rod. (Refer to '8-6-2 Gas sampling rod dust filter replacement'.)
- When connecting the gas sampling rod to the gas sampling tube, tighten only by hand. Overtightening with a tool may damage the plastic part of the gas sampling rod.

- 1 Insert the push-fit coupler on the end of the gas sampling tube into the gas inlet (GAS IN) on the main unit.**
Press the push-fit coupler in firmly until you hear a click.

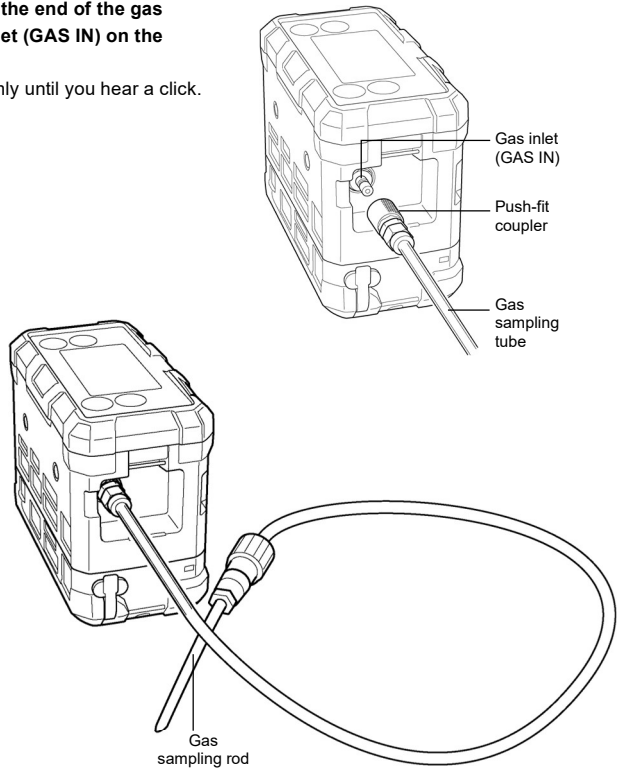

NOTE

▶ In the case of hydrogen (H₂) type, the design is such that the operation of the pressure sensor be switched off so that a flow abnormality due to a decrease in pressure is not triggered when high concentrations of H₂ are suctioned. The filter tube with flow monitor allows you to check that suction is being provided by the product.

<How to check>

•When suction is being applied.

A white disc is visible from the exterior.

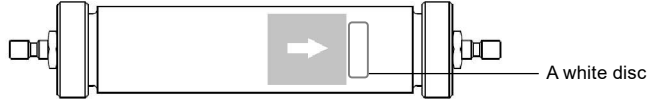

•When suction is not being applied.

A white disc is not visible from the exterior.

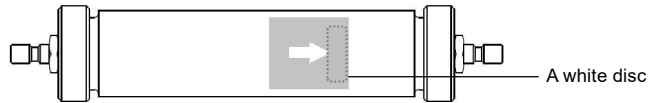

5-4 Turning on the power

When the power is turned on, various settings including the date and time and alarm setpoints are displayed, and then the measurement mode screen is displayed.

NOTE

- ▶ When the power is turned on, the LCD, lamps, and buzzer operate. Before using the product, check that these operations function correctly.

- 1 Hold down the POWER/ENTER button (for at least three seconds) until the buzzer blips once.**
When the power is turned on, the LCD display fully lights up and changes automatically as shown below before entering measurement mode. (Approx. 40 seconds)

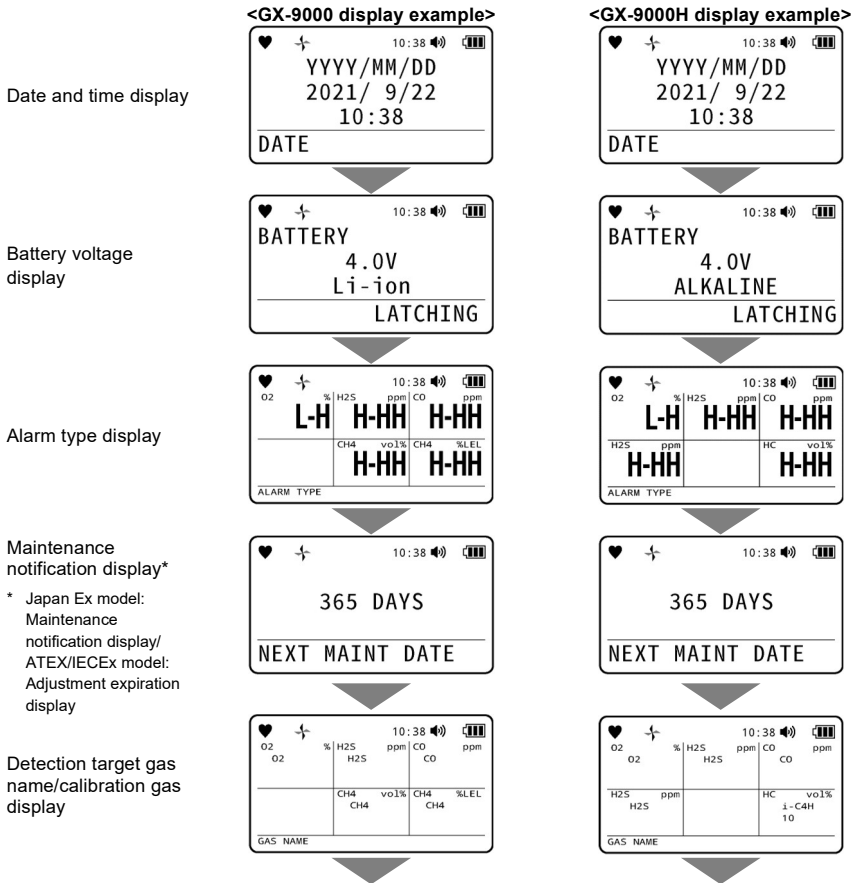

Full scale display

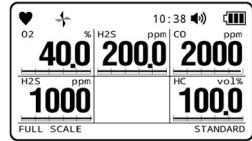
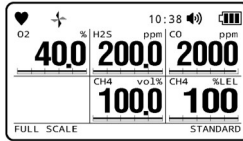

First alarm setpoint display

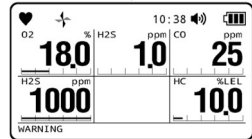
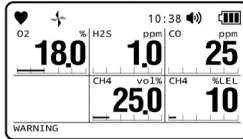

Second alarm setpoint display

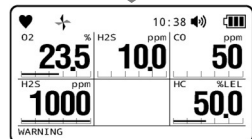
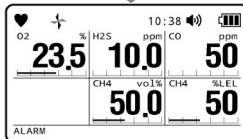

STEL alarm setpoint display

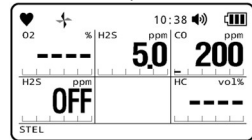
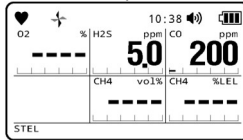

TWA alarm setpoint display

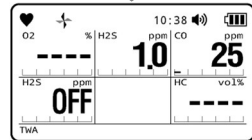
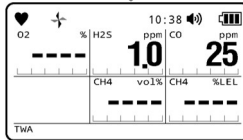

User ID display

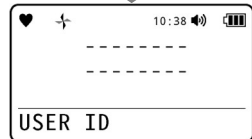
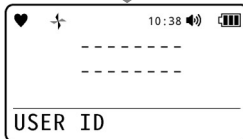

Station ID display

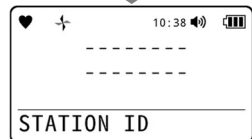
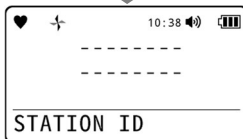

Measurement mode
The buzzer blips twice and the product enters measurement mode.

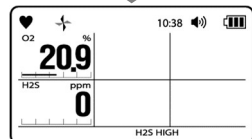
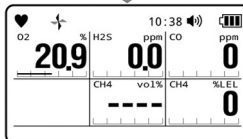



CAUTION

- Turn on the power for the product in clean air.
- Fresh air adjustment must be performed before measuring gas concentrations after turning on the power. (Refer to '5-6 Performing fresh air adjustment in measurement mode'.)

NOTE

- ▶ If an abnormality is detected in the R sensor PCB, R sensor, or F sensor, [FAIL] will appear, and a sensor abnormality alarm will be triggered.
If an alarm occurs, press the RESET/▼ button to temporarily reset the sensor abnormality alarm. However, the alarm cannot be reset if there is an abnormality in all of the sensors. After the alarm is reset, [----] appears in the concentration display area of the gas for which the sensor abnormality occurred, and measurement is not possible for that particular gas. Contact RIKEN KEIKI immediately.
- ▶ If an F sensor abnormality occurs and a sensor abnormality is displayed three times in succession, a confirmation screen will appear asking whether to disable the F sensor. To disable the F sensor, press the POWER/ENTER button. (If you do not wish to disable the sensor, press the DISP/ESC button.) If no selection is made within 15 seconds, the next item in initial mode will be selected automatically without disabling the F sensor.
- ▶ If an abnormality arises in the internal clock, a fault alarm ([FAIL CLOCK]) may be triggered. If a fault alarm occurs, press the RESET/▼ button to temporarily reset the fault alarm. Measurement will start with the incorrect clock time and date.
- ▶ In modes other than measurement mode and display mode, the LEDs flash every four seconds.

Date and time display

- ▶ If a USB connection is detected while the date and time is displayed, the product enters to communication mode.
- ▶ Communication mode can also be selected by pressing the RESET/▼ and DISP/ESC buttons simultaneously while the date and time is displayed.

Power supply voltage display

- ▶ This displays the type of battery installed and alarm type.
- ▶ If a USB connection is detected while the battery voltage is displayed, the product enters communication mode.
- ▶ Communication mode can also be selected by pressing the RESET/▼ and DISP/ESC buttons simultaneously while the battery voltage is displayed.

Sensor startup display

- ▶ [SENSOR START UP] is displayed on the screen if the F sensor startup processing is not completed by the time the battery voltage display ends.

Pump warm-up display (GX-9000H)

- ▶ With the GX-9000H, [PUMP WARM UP] is displayed on the screen while the internal pump warms up after the alarm type display.

Maintenance notification display (Japan Ex model)

- ▶ With Japan Ex models, the number of days until one year (365 days) after the last adjustment date is displayed. [PLEASE CAL] is displayed on the LCD and the buzzer sounds if more than one year has elapsed since the last adjustment date. Press the DISP/ESC button or RESET/▼ button to proceed to the next screen.

Adjustment expiration display (ATEX/IECEx model)

- ▶ When the adjustment notification expiration display setting is enabled with the ATEX/IECEx model (enabled by default), the number of days remaining until the adjustment notification expiration is displayed. If the set adjustment expiration date has passed, notification of expiration is given. The behavior varies depending on the adjustment expiration function settings. The default setting is "Confirm".

- Confirm: Triggers a fault alarm. Press the DISP/ESC button or RESET/▼ button to proceed to the next screen. Pressing the POWER/ENTER button selects user mode gas adjustment.
- Do not confirm: The next screen is automatically displayed after six seconds. Pressing the POWER/ENTER button selects user mode gas adjustment.
- Disable: Triggers a fault alarm. User mode gas adjustment is automatically selected after six seconds.

Bump test expiration display

- ▶ When the bump test expiration function is enabled (disabled by default), the bump test expiration and number of days remaining until bump test expiration are displayed. If the set bump test expiration date has passed, notification of expiration is given.

The behavior varies depending on the bump test expiration function settings. The default setting is "Confirm".

- Confirm: Triggers a fault alarm. Press the DISP/ESC button or RESET/▼ button to proceed to the next screen. Pressing the POWER/ENTER button selects user mode gas adjustment.
- Do not confirm: The next screen is automatically displayed after six seconds. Pressing the POWER/ENTER button selects user mode gas adjustment.
- Disable: Triggers a fault alarm. User mode gas adjustment is automatically selected after six seconds.

PID gas name display

- ▶ When a VOC sensor is installed, the VOC sensor gas name and model (10.6 eV/10.0 eV) are displayed.

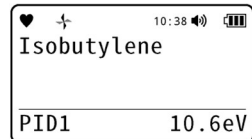
**Combustible gas conversion gas name display**

- ▶ Displays the conversion gas name when the NCF sensor is used with combustible gas conversion.

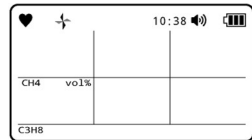
**Full scale display**

- ▶ Displays the full-scale value of the detection target gas. [IEC] or [ISO] is displayed at the bottom of the screen if IEC or ISO LEL values are set. [STANDARD] is displayed in other cases. Note that the LEL setting cannot be changed on the main unit.

First alarm setpoint display

- ▶ Displays the first alarm setpoint for the detection target gas.

Second alarm setpoint display

- ▶ Displays the second alarm setpoint for the detection target gas.

STEL alarm setpoint display

- ▶ Displays the STEL alarm setpoint for the detection target gas. [OFF] is displayed when the STEL alarm setpoint is disabled. [----] is displayed when the STEL alarm setpoint is invalid.
- ▶ The STEL value is the time-weighted average exposure over a short duration (15 minutes). It is generally accepted that almost all users will not experience adverse health effect if the STEL value does not exceed this value. When both STEL and TWA values are subject to restrictions, both values must be controlled below the specified limits.
- ▶ The STEL value refers to the sum of 15 pieces of average value data for measured values over a period of 60 seconds divided by 15. The value is refreshed every 60 seconds.

TWA alarm setpoint display

- ▶ Displays the TWA alarm setpoint for the detection target gas. [OFF] is displayed when the TWA alarm setpoint is disabled. [----] is displayed when the TWA alarm setpoint is invalid.
- ▶ The TWA value refers to the time-weighted average concentration limit of a toxic substance for a normal 8-hour workday and a 40-hour workweek to which almost all users may be repeatedly exposed without adverse health effect.
- ▶ The TWA value refers to the value obtained by integrating average value data for measured values over a period of 60 seconds and then dividing the integrated value for a period of 8 hours by 480. The value is refreshed every 60 seconds.

Automatic fresh air adjustment confirmation display

- ▶ If the automatic fresh air adjustment function is enabled, a screen is displayed to confirm whether or not to perform fresh air adjustment before proceeding to measurement mode. Pressing the POWER/ENTER button performs fresh air adjustment. With the GX-9000H, fresh air adjustment is performed in both H₂S high concentration measurement mode and H₂S low concentration measurement mode.

To skip fresh air adjustment, press the DISP/ESC button.

The product enters measurement mode when automatic fresh air adjustment ends.

For information on fresh air adjustment, refer to '5-6 Performing fresh air adjustment in measurement mode'.

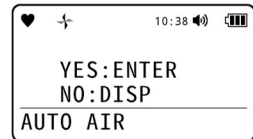

5-5 Selecting hydrogen sulfide measurement mode range (GX-9000H)

With the GX-9000H, you can select between H₂S high concentration measurement mode and H₂S low concentration measurement mode.

H₂S high concentration measurement mode is initially selected at startup.

In H₂S high concentration measurement mode, the product measures oxygen (O₂) and high concentrations of hydrogen sulfide (H₂S).

In H₂S low concentration measurement mode, the product measures combustible gas, oxygen (O₂), carbon monoxide (CO), and low concentrations of hydrogen sulfide (H₂S).

1 Press the ▲/AIR and RESET/▼ buttons simultaneously.

The buzzer blips once, and the product switches between H₂S high concentration measurement mode and H₂S low concentration measurement mode.

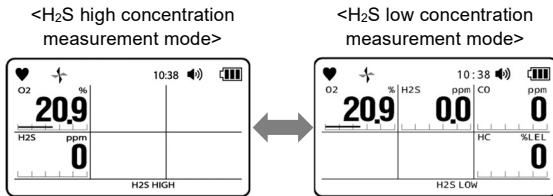

CAUTION

- When measuring in locations where hydrogen sulfide (H₂S) may be present at high concentrations, measure using H₂S high concentration measurement mode.
- When measuring hydrogen sulfide concentrations, first check to confirm that the hydrogen sulfide concentration is below 100 ppm in H₂S high concentration measurement mode before measuring combustible gas and oxygen concentrations in H₂S low concentration measurement mode. Sucking in high concentrations of hydrogen sulfide (H₂S) while in H₂S low concentration measurement mode will damage the carbon monoxide and hydrogen sulfide low concentration sensors.
- If you switch between H₂S low concentration measurement mode and H₂S high concentration measurement mode with high concentrations of combustible gas drawn in, the combustible gas sensor (new ceramic type) may continue to show the [OVER] display. If this occurs, introduce a sufficient amount of clean air, then press the RESET/▼ button and confirm that the reading returns to normal. If the correct reading cannot be obtained, perform fresh air adjustment and gas adjustment.

5-6 Performing fresh air adjustment in measurement mode

Perform fresh air adjustment before measuring gas concentrations.

If a VOC sensor is installed, use the activated carbon filter CF-8350 to remove volatile organic compounds (VOCs) from the air during fresh air adjustment.



WARNING

- When fresh air adjustment is performed in the surrounding atmosphere, check to confirm that the air is clean before starting. Correct fresh air adjustment will not be possible in the presence of miscellaneous gases. It is also extremely dangerous if the product cannot detect actual gas leaks correctly.
- If a VOC sensor is installed, attach the activated carbon filter CF-8350 for fresh air adjustment.



CAUTION

- Use the activated removal filter held upright. Drawing in air with the filter horizontal may allow gas to pass through the top of the activated carbon filter cylinder, preventing miscellaneous gas from being absorbed.
- After using the activated carbon filter, attach the cap to block the air flow.
- Heating the activated carbon filter may release large amounts of miscellaneous gas previously absorbed in the activated carbon filter. If the product sucks in this released miscellaneous gas, it will reduce the service life of the filter inside the detector. Avoid using the product in environments with high levels of miscellaneous gas, and be sure to replace the filter at the stipulated intervals.

To install the activated carbon filter CF-8350, remove the caps on both ends and attach with the arrow on the side pointing toward the gas inlet (GAS IN) of the main unit.

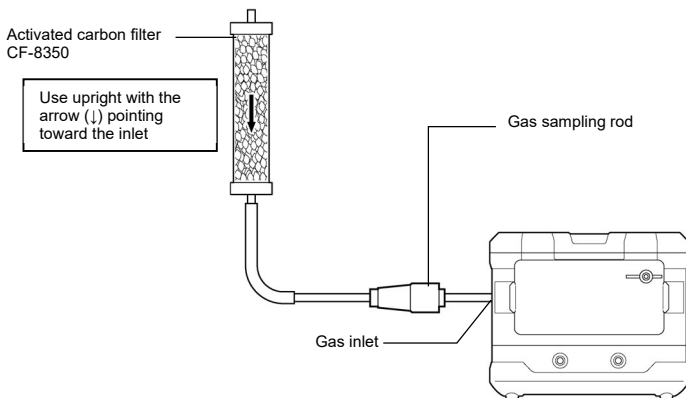



CAUTION

- Perform fresh air adjustment in an environment that meets all of the following conditions:
 - The same pressure, temperature, and humidity to those in the actual usage environment
 - In clean air
- Wait for the reading to stabilize before performing fresh air adjustment.
- If the temperature difference between the storage location and usage location is 15 °C or greater, turn on the power and allow the product to adjust to ambient conditions similar to those at the usage location for about 10 minutes. After this, perform fresh air adjustment in clean air before use.
- By default, fresh air adjustment is not applied to the carbon dioxide sensor. It must therefore be adjusted using CO₂ zero adjustment.
- Perform CO₂ zero adjustments at regular intervals. Also perform CO₂ zero adjustment if the CO₂ reading deviates significantly from the typical atmospheric CO₂ concentration range of 400 – 500 ppm, even in clean air. (Refer to '8-2-3 Performing CO₂ zero adjustment'.)
- To perform fresh air adjustment for the carbon dioxide sensor, enable the CO₂ fresh air adjustment setting in user mode. (Refer to '7-4-2 Enabling/disabling CO₂ fresh air adjustment'.)
 Note however that when fresh air adjustment is performed with the CO₂ fresh air adjustment setting enabled, the carbon dioxide sensor will be automatically set to 400 ppm for the air sucked in and not the actual carbon dioxide concentration. Although the concentration of carbon dioxide (CO₂) in the atmosphere is typically around 400 – 500 ppm, correct adjustment may not be possible depending on the environmental carbon dioxide level. In such cases, we recommend adjustment using CO₂ zero adjustment. (Refer to '8-2-3 Performing CO₂ zero adjustment'.)
- Do not enable the CO₂ fresh air adjustment setting when VOC sensors are installed. Correct adjustment will not be possible due to the carbon dioxide (CO₂) generated by the activated carbon filter CF-8350.
- If the fresh air adjustment during measurement function is disabled, fresh air adjustment is not possible.
 Modify the setting for the fresh air adjustment during measurement function using the setup program sold separately.
- If a TEF sensor (methane (CH₄) or isobutane (HC (i-C₄H₁₀)) type) and oxygen sensor are installed, base gas adjustment must also be performed after fresh air adjustment. (Refer to '8-2-4 Performing base gas adjustment' and the '<The effects of coexisting gas on high-concentration combustible gas sensors>' note in '5-7-1 Measuring gas concentration'.)
- If a TEF sensor (methane (CH₄) or isobutane (HC (i-C₄H₁₀)) type) is installed and no oxygen sensor is installed, and a TEF sensor (hydrogen (H₂) type) is installed, fresh air adjustment is not applied. Perform only base gas adjustment. (Refer to '8-2-4 Performing base gas adjustment' and the '<The effects of coexisting gas on high-concentration combustible gas sensors>' note in '5-7-1 Measuring gas concentration'.)

NOTE

<GX-9000H>

- ▶ Perform fresh air adjustment separately in H₂S high concentration measurement mode and H₂S low concentration measurement mode. Press the ▲/AIR and RESET/▼ buttons simultaneously. The buzzer blips once, and the product switches between H₂S high concentration measurement mode and H₂S low concentration measurement mode.

1 Hold down the ▲/AIR button in measurement mode.

The fresh air adjustment screen is displayed.
Keep the ▲/AIR button pressed for as long as the screen shown on the right is displayed.
Fresh air adjustment will not be performed if you release the button before the screen shown on the right is displayed or while it is displayed.

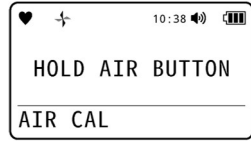

2 Release the ▲/AIR button once [RELEASE] appears on the screen.

The result is displayed and the product automatically returns to measurement mode once fresh air adjustment has been successfully completed.

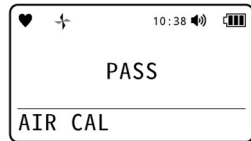

NOTE

- ▶ If fresh air adjustment fails, fresh air adjustment is not performed, and [FAIL] appears in the concentration display area for the failed sensor.
Press the RESET/▼ button to reset the fault alarm (adjustment failure). Resetting the alarm displays the value prior to fresh air adjustment.

5-7 Measurement



DANGER

Usage

- If measuring inside manholes or enclosed spaces, never lean over or look into the manhole or enclosed space. There is a danger that oxygen-deficient air or other gases may be discharged from such locations.

Gas outlet

- Oxygen-deficient air or other gas may be discharged from the gas outlet. Never breathe in this air.
- High-concentration gas may be discharged. Be sure to maintain a safe distance from flame sources.



WARNING

- The product is designed to draw in gas at atmospheric pressure. There is a danger that detection target gas may leak from inside the product if an excessive pressure is applied to the product gas inlet (GAS IN) or outlet (GAS OUT). Be careful to avoid excessive pressure during use.
- Do not connect a gas sampling tube directly to locations subject to a pressure above the atmospheric pressure. Doing so may result in damage to the internal pipes.
- A gas alarm indicates the presence of extreme danger. The user must take appropriate action.
- Check the battery level before using the product. The batteries may be depleted when the product is used for the first time or after extended periods without use. Always fully charge or replace with new batteries before use.
- Gas measurement will not be possible if a battery low voltage alarm occurs. If the alarm occurs during use, turn off the power and promptly charge or replace the batteries in a safe place.
- Do not block the buzzer sound opening. Doing so will muffle or silence the audible warning.



CAUTION

- Check the product settings before starting gas measurement.
- When measuring gas, connect the gas sampling rod provided to avoid the effects of airborne dust.
- With the NCF sensor, continuously measuring high concentrations of combustible gases that exceed the full-scale range for an extended period may negatively impact the sensor. Note that switching to a thermal conductivity type sensor will have no adverse effects, as the NCF sensor is not used for measurement.
- Use the product with the LCD display facing upward. Correct readings may not be obtained if it is used at an angle or laid flat.
- Do not expose the product to sudden pressure fluctuations. Oxygen readings (O₂) will vary temporarily, preventing accurate measurement.
- If highly adsorptive gas has been sucked in, allow the product to suck in clean air, and confirm that the reading returns to zero before use.
- If the separately sold sampling tube with float or weight is used when measuring highly adsorptive gas, the gas may be adsorbed inside the tube, resulting in a lower concentration reading than the actual concentration of the detection target gas at the measurement point.

- Some sensors may exhibit positive sensitivity to gases other than the detection target gas. Note that when the product is used in an environment where such gases are present, the reading may be higher than the actual concentration of the detection target gas present.

<Examples of interference gases to which the sensor exhibits positive sensitivity>

| Sensor detection principle | Detection target gas name | Interference gas |
|-------------------------------------|---|---------------------------------------|
| New ceramic type | Methane (CH ₄)/isobutane (HC (i-C ₄ H ₁₀))/hydrogen (H ₂)/acetylene (C ₂ H ₂) | All combustible gases |
| Non-dispersive infrared type (NDIR) | Methane (CH ₄)/isobutane (HC (i-C ₄ H ₁₀)) | Hydrocarbon combustible gases |
| Photo-ionization type (PID) | Volatile organic compounds (VOCs) | All volatile organic compounds (VOCs) |

- Due to their operating principle, electrochemical type sensors may exhibit negative sensitivity to certain interference gases. In environments where interference gases are present, the reading may be lower than the actual concentration of the detection target gas present, and particularly at high concentrations, the reading may even turn negative, triggering an M OVER alarm. (Refer to '12-5 List of interference gases for electrochemical type sensors'.)
- Due to their operating principles, infrared type CO₂ sensors may exhibit negative sensitivity when high concentrations of hydrocarbons are present.
- Note that if new ceramic type combustible gas sensors are used in an environment where silicone compounds, halides, high-concentration sulfides, or high-concentration solvent gases are present, sensor life may be reduced, sensitivity to combustible gases may deteriorate, and accurate readings may not be obtained.

If use in such environments is unavoidable, use for the shortest possible time and allow the product to suck in clean air afterward. Confirm that the reading returns to normal and is stabilized.

- An oxygen concentration of at least 10 vol% is required in order for the new ceramic type combustible gas sensor (%LEL) in the product to accurately measure gases and display concentrations.
- Due to the sensor characteristics, an accurate reading may not be displayed immediately after turning on the power. Allow the product to warm up for at least one minute after turning on the power to allow the reading to stabilize before use. Allow the product to warm up for at least 10 minutes after turning on the power before performing gas adjustment.
- The reading of the carbon monoxide sensor may rise if exposed to high concentrations of volatile organic compounds (VOCs). If the reading rises and will not return, the activated carbon filter in the carbon monoxide sensor must be replaced. For information on activated carbon filter replacement, contact RIKEN KEIKI.
- The zero point for carbon monoxide and hydrogen sulfide sensors may fluctuate at low or high temperatures. If this occurs, perform fresh air adjustment in the ambient atmosphere.
- The hydrogen sulfide sensor may exhibit temporary fluctuations if exposed to sudden temperature variations. Allow the product to stand and acclimatize in the ambient atmosphere.
- If the VOC sensor is exposed to high concentrations of methane (CH₄), ethane (C₂H₆), propane (C₃H₈), or other gases, [----] may appear on the concentration display, the lamps may flash, and the buzzer may sound, temporarily disabling measurement. In environments where these gases are present, even if the concentration display does not indicate [----], be aware that the VOC concentration may not be accurately measured.

Note that, even if the VOC sensor concentration display indicates [----], other unaffected sensors can continue measurement.

<Example interference gases causing [----] to be displayed on the VOC sensor concentration display>

| Interference gas | Concentration |
|--|-----------------|
| Methane (CH ₄) | 6 vol% or more |
| Ethane (C ₂ H ₆) | 80 vol% or more |
| Propane (C ₃ H ₈) | 90 vol% or more |

- Use the sampling tube with weight in conjunction with the CF-8385 absorbent cotton filter. The CF-8385 absorbent cotton filter is used to remove dust and protect against water. When using the sampling tube with weight, the filter cylinder retaining belt and connecting tube must also be used. If water is sucked in without using the CF-8385 absorbent cotton filter, water will get inside the main unit, causing it to fail.
- If the separately sold sampling tube with float or weight is used when measuring highly adsorptive gas, the gas may be adsorbed inside the tube, resulting in a lower concentration reading than the actual concentration of the detection target gas at the measurement point.
- The CF-8385 absorbent cotton filter is recommended for dusty environments, as the IRF sensor is susceptible to the effects of dust.
- Do not use the separately sold tubes or filters when the ESF sensor (except for the ESF-A24R2 (high-concentration H₂S)) or VOC sensor is installed, due to the risk of adsorption, even when recommended above.



CAUTION

<GX-9000H>

- ▶ When measuring in locations where hydrogen sulfide (H₂S) may be present at high concentrations, measure using H₂S high concentration measurement mode.
- ▶ When measuring hydrogen sulfide concentrations, first check to confirm that the hydrogen sulfide concentration is below 100 ppm in H₂S high concentration measurement mode before measuring combustible gas and oxygen concentrations in H₂S low concentration measurement mode. Sucking in high concentrations of hydrogen sulfide (H₂S) while in H₂S low concentration measurement mode may damage the combustible gas (new ceramic type), carbon monoxide, and low concentration hydrogen sulfide sensors.

NOTE

- ▶ The refresh intervals for each sensor gas concentration display are as follows:

| Sensor type | Gas concentration display refresh interval |
|--|--|
| R sensor | Every second |
| F sensor | |
| NCF sensor (new ceramic type) | Every second |
| TEF sensor (thermal conductivity type) | Every 4 seconds |
| IRF sensor (non-dispersive infrared type (NDIR)) | Every 4 seconds |
| ESF/ESR sensor (electrochemical type) | Every second |
| PIF sensor (photo-ionization type (PID)) | Every second |

5-7-1 Measuring gas concentration

Measure gas concentrations in measurement mode.

Bring the gas sampling rod close to the location to be measured.

The product sucks in the detection target gas, and the measurement results are displayed on the LCD display.

<GX-9000>

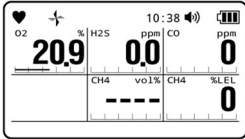

<GX-9000H>

H₂S high concentration measurement mode

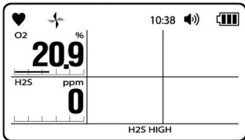

H₂S low concentration measurement mode

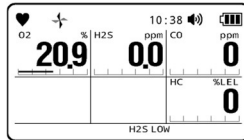

NOTE

- ▶ The operating time will be reduced due to battery performance in cold environments at -10 °C or below.
- ▶ The response of the LCD display may slow at low temperatures.
- ▶ If combustible gas is drawn in at high concentrations of 100 %LEL or above, gas adsorbed in the gas sampling tube and gas sampling rod may remain inside the tube. After drawing in high-concentration combustible gas, always draw in clean air and perform air cleaning until the reading returns to around zero to remove any adsorbed gas. Performing fresh air adjustment before complete cleaning may prevent accurate fresh air adjustment and may adversely affect measurement. In this case, faulty adjustment can be prevented by first detaching the gas sampling tube and then performing fresh air adjustment.

Sensors

- ▶ The conversion gas name is displayed at the bottom of the screen when combustible gas conversion is set. (Refer to '6-4-2 Combustible gas conversion gas selection'.)
- ▶ If the combustible gas reading exceeds 100 %LEL, the carbon monoxide (CO) reading will increase temporarily, but this is not an abnormality.
- ▶ When measuring in locations where combustible gas may be present at high concentrations, measure using the vol% range.
- ▶ If the oxygen concentration drops below 10 %, the combustible gas concentration reading for NCF sensors will appear as [----]. If the NCF/TEF sensor range setting is set to [AUTO RANGE] (default setting), the display changes to the TEF sensor reading. If [LEL ONLY] is set, measurement will not be performed. Reassess the usage environment. (Refer to '6-4-1 Setting the NCF/TEF sensor range'.)
- ▶ If the oxygen sensor (ESR-X13P) is not installed or if the combustible gas concentration is displayed only in the %LEL range, the OVER alarm will remain fixed if the measured combustible gas concentration exceeds 100 %LEL.

To reset the alarm, press the RESET/▼ button in the presence of clean air. The concentration display resumes a short while after pressing the RESET/▼ button.

<The effects of coexisting gas on high-concentration combustible gas sensors>

- ▶ TEF sensors used to measure high-concentration combustible gas rely on differences in the thermal conductivity of gases. Readings may therefore be affected if gases are present in high concentrations, even for gases other than combustible gases present in the air.

- ▶ When a TEF sensor (methane (CH₄) type or isobutane (HC (i-C₄H₁₀)) type) and oxygen sensor are installed, a function* that automatically compensates for the effects on readings by feeding back oxygen concentration fluctuations to the high-concentration combustible gas measurement results eliminates the effects of oxygen concentration.

Base gas adjustment (at an oxygen concentration of 0 %) must therefore be performed in addition to fresh air adjustment (at an oxygen concentration of 20.9 %) in order to correct the oxygen concentration accurately.

* The effects cannot be compensated for if coexisting gases other than oxygen (O₂) are present.

- ▶ When a TEF sensor (methane (CH₄) type or isobutane (HC (i-C₄H₁₀)) type) is installed and no oxygen sensor is installed, oxygen concentration changes will not be fed back to the high-concentration combustible gas measurement results.

Likewise, if a TEF sensor (hydrogen (H₂) type) is installed, the oxygen sensor readings will be affected by hydrogen (H₂), preventing feedback of oxygen concentration changes to high-concentration combustible gas measurement results.

With these specifications, fresh air adjustment (at an oxygen concentration of 20.9 %) is not applicable, and only base gas adjustment (at an oxygen concentration of 0 %) needs to be performed. Note that high-concentration fluctuations for coexisting gases may have an impact, but the effects of the oxygen concentration in the air (20.9 %) can be minimized by selecting [N₂] as the gas for base gas adjustments (refer to '7-4-3 Selecting gas type for base gas adjustment') and performing base gas adjustments using air. (Refer to '8-2-4 Performing base gas adjustment'.)

- ▶ The product is designed to allow measurement of high concentrations of combustible gas in air as well as in nitrogen (N₂) atmospheres and inert gas atmospheres (assumed as nitrogen (N₂): 86 vol%, carbon dioxide (CO₂): 14 vol%). If the composition is known in advance, the product can be adjusted to suit that atmosphere and ensure accurate readings.

5-7-2 Combustible gas concentration range changeover points

The product will automatically switch to the vol% range when the combustible gas concentration measured exceeds 100 %LEL.

The range automatically reverts to %LEL when the concentration falls.

NOTE

- ▶ The %LEL and %vol ranges are measured using sensors that rely on different principles, so the readings may not coincide temporarily in the vicinity of the changeover point.

<NCF/TEF sensors>

The combustible gas concentration shows the case for methane (CH₄).

The range changeover point is at the gas lower explosive limit (LEL). For methane (CH₄), this is 5.0 vol%. It will vary depending on the gas type and model. The 100 %LEL value is displayed in the full scale display at startup. (Refer to '5-4 Turning on the power'.)

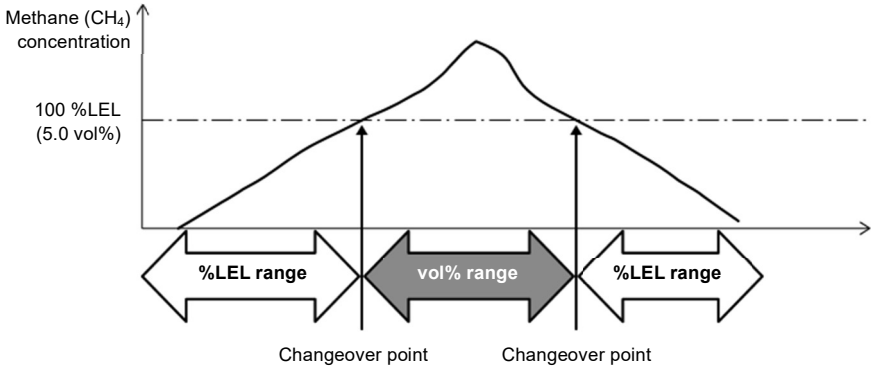

<IRF sensors>

The range changeover point is at 100 %LEL.

It will vary depending on the gas type and model. The 100 %LEL value is displayed in the full scale display at startup. (Refer to '5-4 Turning on the power'.)

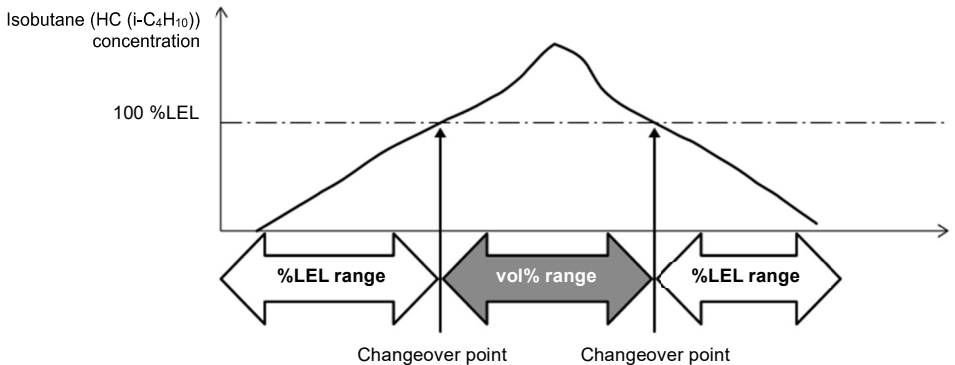

5-7-3 Basic operating flow in measurement mode

<GX-9000>

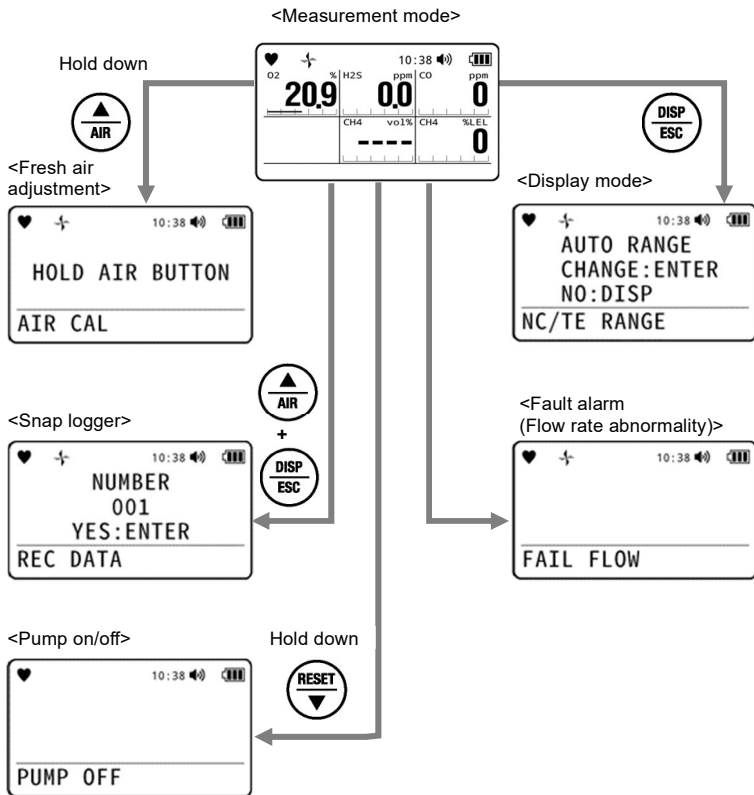

<GX-9000H>

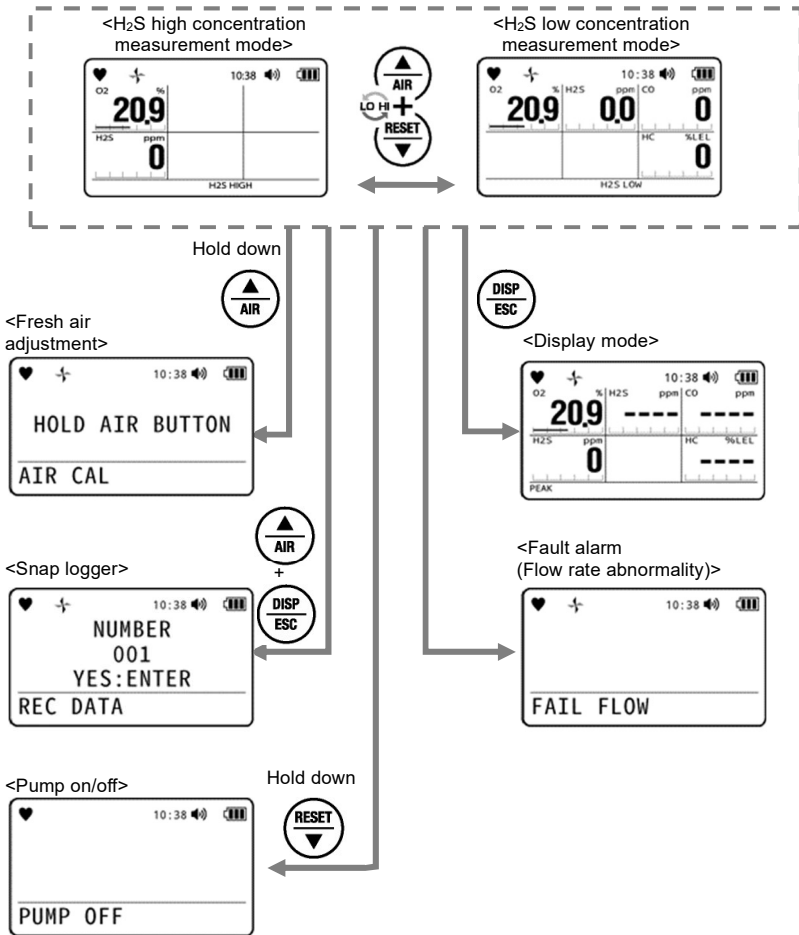

5-7-4 Confirmation beep operation

The confirmation beep is a function that provides audible notification of bump test expiration and gas alarms when the product is operating normally.

The buzzer and LEDs operate at preset intervals while measurement is underway.

NOTE

- ▶ The confirmation beep operates only in measurement mode and display mode.
- ▶ If a gas alarm has occurred, the gas alarm takes precedent.
- ▶ The confirmation beep operation can be modified using the setup program sold separately.

The buzzer and LEDs operate as follows depending on the confirmation beep operation type. The default setting is [OFF].

- [OFF]: Do not operate.
- [LED]: The LEDs operate twice at the set operating time interval.
- [BUZZER]: The buzzer sounds twice at the set operating time interval.
- [LED+BUZZER]: The LEDs and buzzer operate twice at the set operating time interval.
- [BUMP/CAL]: The LEDs light up for one second at the set operating time interval when the bump test expiration function is enabled and the span adjustment expiration date has passed or when the bump test expiration function is enabled and the bump test has expired. The buzzer and LEDs continue to operate even when the product is restarted until span adjustment or bump testing has been performed for all of the installed sensors.
- [ALM ALRT]: The LEDs light up for one second at the set operating time interval when a gas alarm (including negative sensor fault) occurs. The buzzer and LEDs continue to operate, even if the product is restarted, until span adjustment or bump testing has been performed for all of the installed sensors.
- [B/C/ALM]: The LEDs light up for one second at the set operating time interval when a gas alarm (including negative sensor fault) occurs when the bump test expiration function is } enabled and the span adjustment expiration date has passed or when the bump test expiration function is enabled and the bump test has expired. The buzzer and LEDs continue to operate even when the product is restarted until span adjustment or bump testing has been performed for all of the installed sensors.

5-8 Recording gas concentration logs (snap logger)

Up to 256 user-specified gas concentration values can be recorded while measurement is in progress. If the number of recorded data values exceeds 256, the oldest data value will be overwritten.

1 Press the ▲/AIR and DISP/ESC buttons simultaneously on the measurement mode screen.

The record number, station ID, record date and time, and current gas concentration to be recorded are displayed repeatedly in succession.

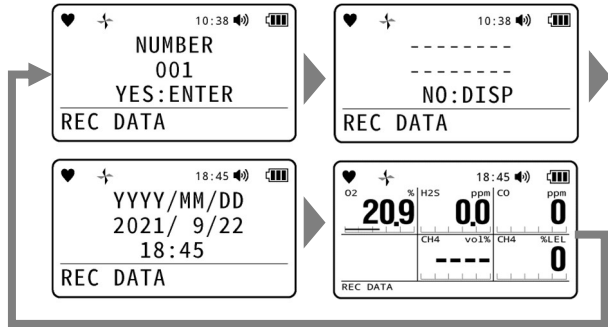

2 Press the POWER/ENTER button.

If you do not wish to record, press the DISP/ESC button.

The current gas concentration is recorded.

[END] appears and the display returns to the measurement mode screen.

NOTE

- ▶ Press the ▲/AIR and DISP/ESC buttons simultaneously. The display mode screen will be displayed if the buttons are not pressed together. If this occurs, release both buttons, return to the measurement mode screen, then repeat the process.
- ▶ The recorded data can be checked on the snap logger display screen in display mode. (Refer to '6-3-2 Displaying the snap logger (gas concentration/alarm status)'.)

5-9 Stopping the pump

- 1 Hold down the **RESET/▼** button on the measurement mode screen (for approximately five seconds).

The pump stops.

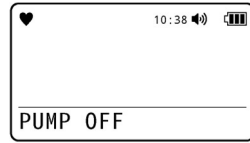

WARNING

- Gas alarms and low flow rate alarms are not triggered while the pump is stopped.

NOTE

- ▶ Either press the **RESET/▼** button while the pump is stopped, or wait 10 minutes for the pump to restart. The measurement mode screen is displayed.

5-10 Turning off the power



CAUTION

- If the concentration display does not return to zero (20.9 % for the oxygen concentration display or around 400 – 500 ppm for the carbon dioxide concentration display) after measurement ends, allow the product to stand in clean air until the display returns to zero before turning off the power.

- 1 **Hold down the POWER/ENTER button (for at least three seconds).**
The buzzer blips three times and [TURN OFF] appears on the display before the power turns off.

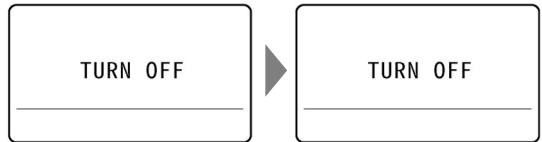

NOTE

- ▶ When turning off the power, hold down the button until the display turns off.
- ▶ If the display has not returned to zero when you turn off the power, purging will be performed for up to 30 seconds to clean the product interior. The screen as shown on the right is displayed while purging is in progress.









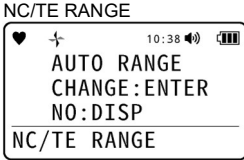
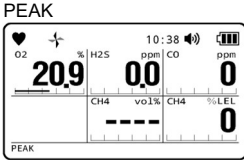
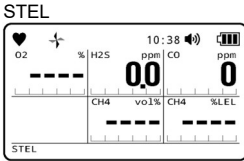
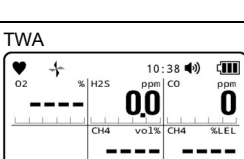
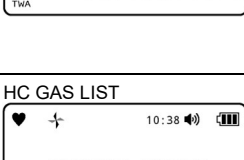

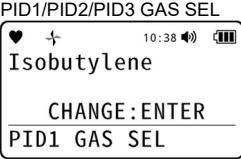

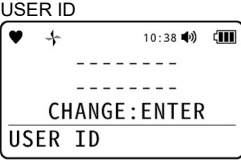

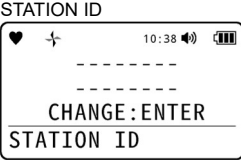

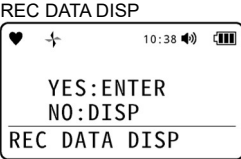

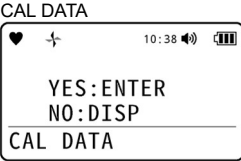

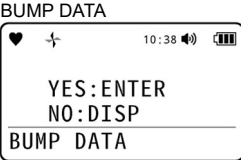
6

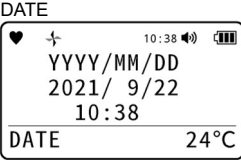
Settings (Display Mode)

6-1 Display mode items

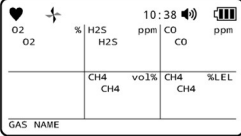
| LCD display | Details | Reference |
|---|--|--|
|  <p>NC/TE RANGE</p> <p>♥ 10:38 </p> <p>AUTO RANGE CHANGE: ENTER NO: DISP</p> <p>NC/TE RANGE</p> | <p>Sets the range selection method for the NCF and TEF sensor detection target gas concentrations. This is displayed when the NCF and TEF sensors are installed.</p> | 6-4-1 Setting the NCF/TEF sensor range |
|  <p>PEAK</p> <p>♥ 10:38 </p> <p>O₂ % H₂S ppm CO ppm</p> <p>20.9 0.0 0</p> <p>CH₄ VO₁% CH₄ %LEL</p> <p>0</p> <p>PEAK</p> | <p>Displays the maximum gas concentration (or minimum concentration for L-H alarm type) measured since the power was turned on.</p> | 6-3-1 Clearing the PEAK value |
|  <p>STEL</p> <p>♥ 10:38 </p> <p>O₂ % H₂S ppm CO ppm</p> <p>--- 0.0 0</p> <p>CH₄ VO₁% CH₄ %LEL</p> <p>---</p> <p>STEL</p> | <p>Displays the STEL value for 15-minute period prior to the current time (or since the power was turned on). The STEL value refers to the sum of 15 pieces of average value data for measured values over a period of 60 seconds divided by 15.</p> <p>The value is refreshed every 60 seconds.</p> <p>If a "-" is listed in the TEL alarm set value section, it will be displayed as [---]. (Refer to '4-2 Gas Alarm Points')</p> | |
|  <p>TWA</p> <p>♥ 10:38 </p> <p>O₂ % H₂S ppm CO ppm</p> <p>--- 0.0 0</p> <p>CH₄ VO₁% CH₄ %LEL</p> <p>---</p> <p>TWA</p> | <p>Displays the TWA value for 8-hour period prior to the current time (or since the power was turned on). The TWA value refers to the value obtained by integrating average value data for measured values over a period of 60 seconds and then dividing the integrated value for a period of 8 hours by 480.</p> <p>The value is refreshed every 60 seconds.</p> <p>If a "-" is listed in the TWA alarm set value section, it will be displayed as [---]. (Refer to '4-2 Gas Alarm Points')</p> | |
|  <p>HC GAS LIST</p> <p>♥ 10:38 </p> <p>CHANGE: ENTER NO: DISP</p> <p>HC GAS LIST</p> | <p>Displays the combustible gas concentration after converting it to the concentration of the conversion gas registered in the product. It is displayed when all of the following conditions are satisfied:</p> <ul style="list-style-type: none"> • An NCF sensor is installed. • No TEF sensor is installed. • The calibration gas is methane (CH₄) or isobutane (HC (i-C₄H₁₀)). | 6-4-2 Combustible gas conversion gas selection |

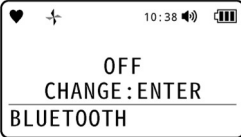
| LCD display | Details | Reference |
|---|---|---|
|  <p>PID1/PID2/PID3 GAS SEL  Isobutylene CHANGE : ENTER PID1 GAS SEL</p> | Displays the volatile organic compound (VOC) concentration after converting it to the concentration of the conversion gas registered in the product. | 6-4-3 Volatile organic compound (VOC) conversion gas selection |
|  <p>USER ID  ----- ----- CHANGE : ENTER USER ID</p> | Sets the user ID. | 6-4-4 Setting the user ID |
|  <p>STATION ID  ----- ----- CHANGE : ENTER STATION ID</p> | Sets the station ID. | 6-4-5 Setting the station ID |
|  <p>REC DATA DISP  YES : ENTER NO : DISP REC DATA DISP</p> | Displays the gas concentration and alarm status recorded by the snap logger function. | 6-3-2 Displaying the snap logger (gas concentration/alarm status) |
|  <p>CAL DATA  YES : ENTER NO : DISP CAL DATA</p> | Displays the date on which gas adjustment was performed for each sensor. This appears with the ATEX/IECEX model when the adjustment expiration function is enabled. | 6-3-3 Displaying adjustment records |
|  <p>BUMP DATA  YES : ENTER NO : DISP BUMP DATA</p> | Displays the date on which the bump test was performed for each sensor. It is displayed when the bump test expiration function is enabled. | 6-3-4 Displaying bump test records |
|  <p>DATE  YYYY/MM/DD 2021/ 9/22 10:38 DATE 24°C</p> | Displays the current date and time and temperature (°C). The temperature is the product internal temperature. This will differ from the actual ambient temperature. | |

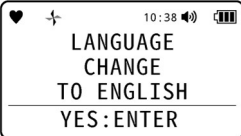
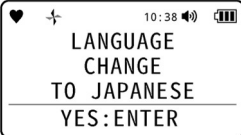
| LCD display | Details | Reference |
|--|---|---|
| <p>GAS NAME</p>  <p>GAS NAME</p> | <p>Displays the target gas names and calibration gas names.</p> | |
| <p>ALARM POINTS</p>  <p>ALARM POINTS</p> | <p>Displays the full-scale value, first alarm setpoint, second alarm setpoint, STEL alarm setpoint, and TWA alarm setpoint for each sensor.</p> | <p>6-3-5 Displaying alarm setpoints</p> |
| <p>BLUETOOTH</p>  <p>BLUETOOTH</p> | <p>Sets the connection to a Bluetooth device when the Bluetooth function is enabled.</p> | <p>6-4-6 Setting a Bluetooth device connection</p> |
| <p>BUZZER VOLUME</p>  <p>BUZZER VOLUME</p> | <p>Selects the buzzer volume setting.</p> | <p>6-4-7 Setting the buzzer volume</p> |
| <p>TO ENGLISH</p>  <p>TO ENGLISH</p> | <p>Returns the display language to English. This appears with the ATEX/IECEx model when a language other than English has been set.</p> | <p>6-4-8 Switching display language to English (ATEX/IECEx model)</p> |
| <p>TO JAPANESE</p>  <p>TO JAPANESE</p> | <p>Returns the display language to Japanese. This appears with the Japan Ex model when a language other than Japanese has been set.</p> | <p>6-4-9 Switching display language to Japanese (Japan Ex model)</p> |

6-2 Switching to display mode

- 1 Press the DISP/ESC button on the measurement mode screen.

Pressing the DISP/ESC button displays the various setting item screens in sequence.

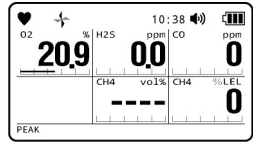
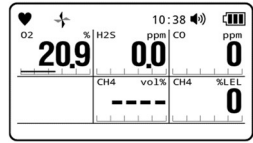

The product returns to measurement mode once the display mode item display has ended.

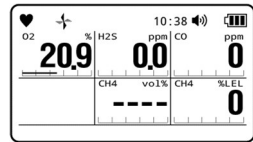

NOTE

- ▶ You can also jump between display mode items by holding down the DISP/ESC button.
- ▶ If no button is pressed for approximately 20 seconds in display mode, the product will return to measurement mode.

NOTE

<GX-9000H>

- ▶ Display mode can be selected from both H₂S high concentration measurement mode and H₂S low concentration measurement mode.

6-3 Checking settings

6-3-1 Clearing the PEAK value

This clears the maximum gas concentration (or minimum oxygen (O₂) concentration) measured since the power was turned on.

NOTE

- ▶ The PEAK value cannot be cleared if the password protection setting is enabled.
- ▶ Disabling the PEAK reset function in [Disp mode item] of the setup program sold separately will prevent the PEAK value from being cleared. (The default setting is enabled.)

- 1 Press the DISP/ESC button several times on the measurement mode screen to display the PEAK screen.

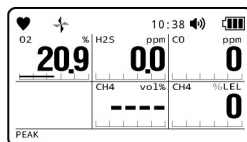

- 2 Hold down the ▲/AIR button (for approximately three seconds).

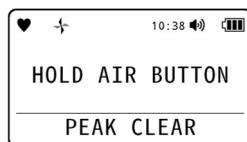

- 3 Release the ▲/AIR button once [RELEASE] appears on the screen.

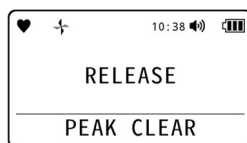

The PEAK value is cleared and the display returns to the screen in Step 1.

6-3-2 Displaying the snap logger (gas concentration/alarm status)

Displays the gas concentration and alarm status recorded by the snap logger function.

1 Press the DISP/ESC button several times on the measurement mode screen to display the snap logger display screen.

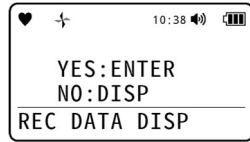

2 Press the POWER/ENTER button. If you do not wish to display the snap logger, press the DISP/ESC button.

3 Press the ▲/AIR or RESET/▼ button to select the record number to be displayed.

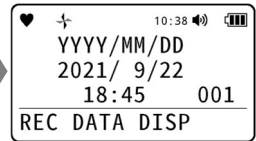
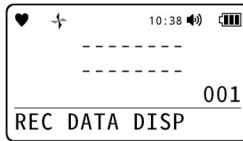

4 Press the POWER/ENTER button. The data is displayed for the record number selected.

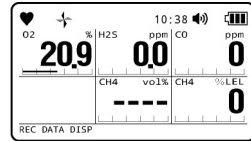

5 Press the DISP/ESC button. The display returns to the screen in Step 3.

NOTE

- ▶ [NO DATA] will be displayed if no snap logs are recorded. If this occurs, press the DISP/ESC button or POWER/ENTER to return to the screen in Step 1.
- ▶ To cancel the snap logger display, press the DISP/ESC button in Step 4.

6-3-3 Displaying adjustment records

Displays the date on which gas adjustment was performed for each sensor.

NOTE

- ▶ Adjustment records are displayed with the ATEX/IECEx model when the adjustment expiration function is enabled (the default setting is enabled).

1 Press the DISP/ESC button several times on the measurement mode screen to display the CAL DATA screen.

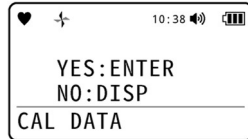

2 Press the POWER/ENTER button.
If you do not wish to display the gas adjustment records, press the DISP/ESC button.

3 Press the ▲/AIR button.
Pressing the ▲/AIR button cycles through the sensors displayed.

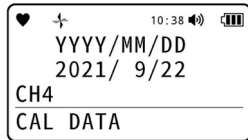

4 Press the DISP/ESC button.
The display returns to the screen in Step 1.

NOTE

- ▶ With a double-range IRF sensor (methane (CH₄), isobutane (HC (i-C₄H₁₀))) that allows adjustment for both high and low concentrations, the adjustment records will be displayed separately for high and low concentrations.

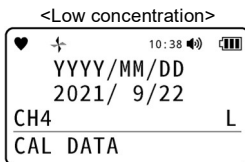
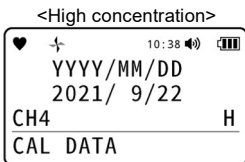

6-3-4 Displaying bump test records

Displays the date on which the bump test was performed for each sensor.

NOTE

- ▶ Bump test records are displayed when the bump test expiration function is enabled (the default setting is disabled).
- ▶ The bump test data is also updated automatically when gas adjustment is performed.

1 Press the DISP/ESC button several times on the measurement mode screen to display the BUMP DATA screen.

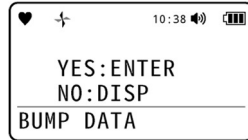

2 Press the POWER/ENTER button.
If you do not wish to display the bump test records, press the DISP/ESC button.

3 Press the ▲/AIR button.
Pressing the ▲/AIR button cycles through the sensors displayed.

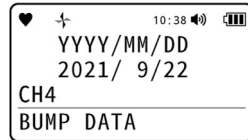

4 Press the DISP/ESC button.
The display returns to the screen in Step 1.

NOTE

- ▶ With a double-range IRF sensor (methane (CH₄), isobutane (HC (i-C₄H₁₀))) that allows adjustment for both high and low concentrations, the bump test records will be displayed separately for high and low concentrations.

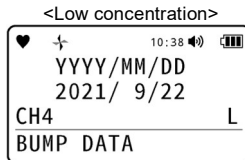
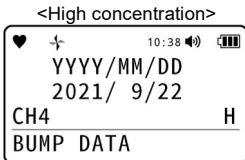

6-3-5 Displaying alarm setpoints

Displays the full-scale value (FULL SCALE), first alarm setpoint (WARNING), second alarm setpoint (ALARM), STEL alarm setpoint (STEL), and TWA alarm setpoint (TWA) for each sensor.

1 Press the DISP/ESC button several times on the measurement mode screen to display the ALARM POINTS screen.

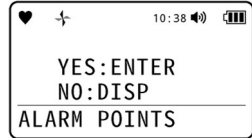

2 Press the POWER/ENTER button.
If you do not wish to display the alarm setpoints, press the DISP/ESC button.

3 Press the ▲/AIR button.
Pressing the ▲/AIR button cycles through the alarm setpoints displayed.

The display changes in the following sequence:
[FULL SCALE] → [WARNING] → [ALARM] → [STEL] → [TWA] → [FULL SCALE] → ...

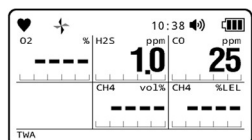
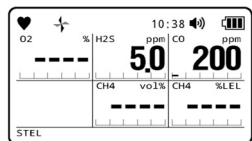
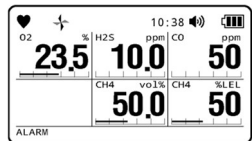
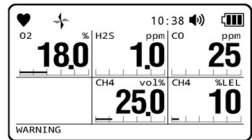
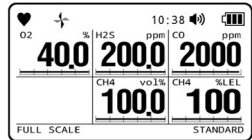

To [FULL SCALE] display

4 Press the DISP/ESC button.
The display returns to the screen in Step 1.

NOTE

- ▶ To test the alarms, press the POWER/ENTER button while an alarm setpoint is displayed. (Refer to '8-4 Performing alarm tests'.)
-

6-4 Display mode settings

6-4-1 Setting the NCF/TEF sensor range

Sets the range selection method for the NCF and TEF sensor detection target gas concentrations. Select one of the following. The default setting is [AUTO RANGE].

- [AUTO RANGE]: The product will automatically switch to the vol% range if the combustible gas concentration measured exceeds 100 %LEL. The range automatically reverts to the %LEL range if the concentration falls. [----] appears in the TEF sensor concentration display area for the %LEL range. [OVER] appears in the NCF sensor concentration display area for the vol% range. (Refer to '5-7-2 Combustible gas concentration range changeover points'.)
- [VOL ONLY]: The measured combustible gas concentration is displayed only in the vol% range. [OFF] appears in the NCF sensor concentration display area.
- [LEL ONLY]: The measured combustible gas concentration is displayed only in the %LEL range. [OFF] appears in the TEF sensor concentration display area.

NOTE

- ▶ The NCF and TEF sensor ranges can be set only when the NCF and TEF sensors are installed. The item does not appear in display mode in other cases.
- ▶ The NCF and TEF sensor range settings are not retained. The setting in effect immediately after turning on the power is [AUTO RANGE].
- ▶ Use the NCF and TEF sensors for the same gas types.
- ▶ When [AUTO RANGE] is set, [----] will appear in the TEF sensor display for NCF sensor measurements. [OVER] will appear in the NCF sensor display for TEF sensor measurements.
- ▶ If the combustible (NCF/TEF) range selection function is disabled in [DISP mode settings] of the setup program sold separately, this setting item will no longer appear in display mode. (The default setting is enabled.)

- 1 Press the DISP/ESC button several times on the measurement mode screen to display the NC/TE RANGE screen.
- 2 Press the POWER/ENTER button.
If you do not wish to set, press the DISP/ESC button.
- 3 Press the ▲/AIR or RESET/▼ button to select the NCF and TEF sensor range selection method.
Select [AUTO RANGE], [VOL ONLY], or [LEL ONLY].
- 4 Press the POWER/ENTER button.

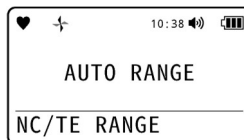
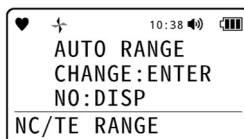

The NCF and TEF sensor ranges are set.
[END] appears, and the display returns to the screen in Step 1.

NOTE

- ▶ To cancel the setting, press the DISP/ESC button in Step 4.

6-4-2 Combustible gas conversion gas selection

The combustible gas concentration can be displayed after converting it to the concentration of the conversion gas registered in the product.

NOTE

- ▶ Combustible gas conversion can be set only when all of the following conditions are satisfied:
 - An NCF sensor is installed.
 - No TEF sensor is installed.
 - The calibration gas is methane (CH₄) or isobutane (HC (i-C₄H₁₀)).
- ▶ The item will not appear in display mode unless the above conditions are satisfied.
- ▶ The combustible gas conversion setting is retained even when the power is turned off.
- ▶ If the combustible gas conversion gas selection function is disabled in [Disp mode item] of the setup program sold separately, this setting item will no longer appear in display mode. (The default setting is enabled.)

The following combustible gases can be converted:

| Gas name | | Conversion from methane (CH ₄) specifications | CH ₄ JG specification | Conversion from isobutane (HC (i-C ₄ H ₁₀)) specifications | HC (i-C ₄ H ₁₀) JG specification |
|---------------|--|---|----------------------------------|---|---|
| Methane | CH ₄ | - | - | Not available | Not available |
| Isobutane | HC (i-C ₄ H ₁₀) | Available | Available | - | - |
| Hydrogen | H ₂ | Available | Available | Available | Available |
| Methanol | CH ₃ OH | Available | Available | Available | Available |
| Acetylene | C ₂ H ₂ | Available | Not available | Available | Available |
| Ethylene | C ₂ H ₄ | Available | Available | Available | Available |
| Ethane | C ₂ H ₆ | Available | Available | Not available | Not available |
| Ethanol | C ₂ H ₅ OH | Available | Available | Available | Available |
| Propylene | C ₃ H ₆ | Available | Available | Available | Available |
| Acetone | C ₃ H ₆ O | Available | Available | Available | Available |
| Propane | C ₃ H ₈ | Available | Available | Not available | Not available |
| Butadiene | C ₄ H ₆ | Available | Not available | Available | Available |
| Cyclopentane | C ₅ H ₁₀ | Available | Available | Available | Available |
| Benzene | C ₆ H ₆ | Available | Available | Available | Available |
| N-hexane | n-C ₆ H ₁₄ | Available | Available | Available | Available |
| Toluene | C ₇ H ₈ | Available | Not available | Available | Available |
| Heptane | n-C ₇ H ₁₆ | Available | Not available | Available | Available |
| Xylene | C ₈ H ₁₀ | Available | Not available | Available | Available |
| N-nonane | n-C ₉ H ₂₀ | Available | Not available | Available | Available |
| Ethyl acetate | EtAc | Available | Not available | Available | Available |

| Gas name | | Conversion from methane (CH ₄) specifications | CH ₄ JG specification | Conversion from isobutane (HC (i-C ₄ H ₁₀)) specifications | HC (i-C ₄ H ₁₀) JG specification |
|------------------------|----------------------------------|---|----------------------------------|---|---|
| IPA | IPA | Available | Available | Available | Available |
| MEK | MEK | Available | Not available | Available | Available |
| Methyl methacrylate | MMA | Available | Not available | Available | Available |
| Dimethyl ether | DME | Available | Available | Available | Available |
| Methyl isobutyl ketone | MIBK | Available | Not available | Available | Available |
| Tetrahydrofuran | THF | Available | Available | Available | Available |
| N-pentane | n-C ₅ H ₁₂ | Available | Available | Available | Available |

NOTE

- ▶ The concentration display when converted should be treated as approximate.
- ▶ The product specifications vary depending on the combustible gas to be measured. Depending on the product specifications, certain gas types may not be converted.
- ▶ Even if the combustible conversion gas function is selected, the readings will be affected if other combustible gases are present in the usage environment.
- ▶ If the combustible gas conversion function is used, the indication accuracy for the product will not be achieved.
- ▶ In the JG type approval specification, even if the alarm is triggered at 30% LEL, be aware that the gas concentration may actually exceed 30% if the gas being measured is subject to correction using the correction factor table.
- ▶ In the JG type approval specification, when using the flammable gas substitution function, please select a gas type marked as "Permitted" in the "JG specification" column of the above table. Selecting a gas type marked as "Not permitted" will result in non-compliance with JG type approval requirements.

- 1 Press the DISP/ESC button several times on the measurement mode screen to display the HC GAS LIST screen.
- 2 Press the POWER/ENTER button.
If you do not wish to set, press the DISP/ESC button.
- 3 Press the ▲/AIR or RESET/▼ button to select the gas type for conversion.
- 4 Press the POWER/ENTER button.

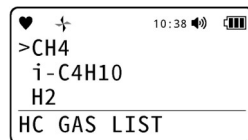
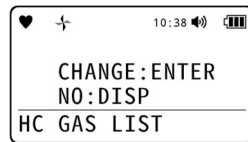

Conversion will be performed for the selected gas type. [END] appears, and the display returns to the screen in Step 1.

NOTE

- ▶ To cancel the setting, press the DISP/ESC button in Step 4.

6-4-3 Volatile organic compound (VOC) conversion gas selection

Volatile organic compound (VOC) concentration is normally displayed as isobutylene (C_4H_8), but this can be displayed converted to a specific pre-registered gas.

For information on volatile organic compound (VOC) conversion gas types, refer to 'TED0284 Volatile organic compound (VOC) conversion gas list' from the product information page on the RIKEN KEIKI website.

NOTE

- ▶ Volatile organic compound (VOC) conversion can be set only when a VOC sensor is installed. The item does not appear in display mode in other cases.
- ▶ The list of gas types displayed will vary depending on the VOC sensor model (10.6 eV/10.0 eV) installed.
- ▶ The list of gas types displayed is as follows:
 - List set using the MT-9000 Series setup program (up to 30 for each VOC sensor model)
 - Recently used gas types (up to seven for each VOC sensor model)
 - Lists by first letter A to Z
- ▶ If the PID gas list function is disabled in [Disp mode item] of the setup program sold separately, this setting item will no longer appear in display mode. (The default setting is enabled.)

- 1 Press the DISP/ESC button several times on the measurement mode screen to display the PID1 GAS SEL screen.**

[PID1], [PID2], or [PID3] will be displayed depending on the VOC sensor model.

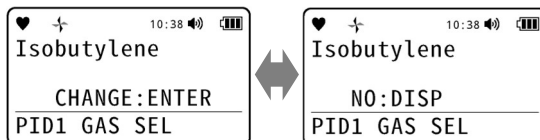

- 2 Press the POWER/ENTER button.**

If you do not wish to set, press the DISP/ESC button.

- 3 Press the ▲/AIR or RESET/▼ button to select the first letter of the gas type for conversion.**

- 4 Press the POWER/ENTER button.**

The gas types beginning with the first letter selected are displayed.

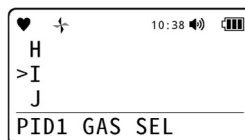

- 5 Press the ▲/AIR or RESET/▼ button to select the gas type for conversion.**

- 6 Press the POWER/ENTER button.**

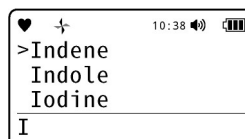

The selected gas type is displayed.

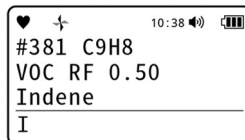

* The example screens here show the display when lists by first letter A to Z are set.

[END] appears, and the display returns to the screen in Step 1.

NOTE

- ▶ Hold down the ▲/AIR or RESET/▼ button on the gas name list to move 10 items up or down at a time.
 - ▶ To cancel the setting, press the DISP/ESC button in Step 6.
-

6-4-4 Setting the user ID

Sets the user ID.

The user ID is used to identify individual users.

- 1 Press the **DISP/ESC** button several times on the measurement mode screen to display the **USER ID** screen.

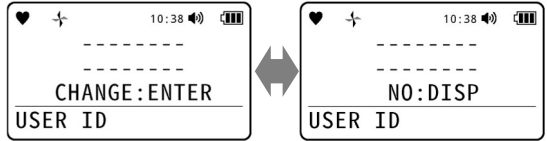

- 2 Press the **POWER/ENTER** button. If you do not wish to set, press the **DISP/ESC** button.

- 3 Press the **▲/AIR** or **RESET/▼** button to select a user ID.

- 4 Press the **POWER/ENTER** button.

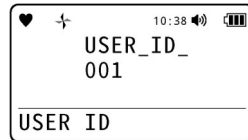

The user ID selected is set.

[END] appears, and the display returns to the screen in Step 1.

NOTE

- ▶ User IDs can be set from USER_ID_001 to USER_ID_128.
- ▶ Hold down the **▲/AIR** or **RESET/▼** button on the user ID list to move 10 items up or down at a time.
- ▶ To cancel the setting, press the **DISP/ESC** button in Step 4.
- ▶ The data logger management program sold separately is required to register and edit user IDs. For information on the data logger management program, contact RIKEN KEIKI.
- ▶ If the user ID selection function is disabled in [Disp mode item] of the setup program sold separately, this setting item will no longer appear in display mode. (The default setting is enabled.)

6-4-5 Setting the station ID

Sets the station ID.

The station ID is used to identify measurement points.

- 1 Press the **DISP/ESC** button several times on the measurement mode screen to display the **STATION ID** screen.

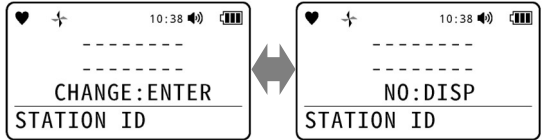

- 2 Press the **POWER/ENTER** button.
If you do not wish to set, press the **DISP/ESC** button.

- 3 Press the **▲/AIR** or **RESET/▼** button to select a station ID.

- 4 Press the **POWER/ENTER** button.

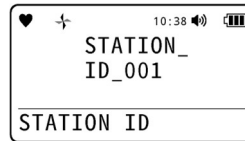

The station ID selected is set.

[END] appears, and the display returns to the screen in Step 1.

NOTE

- ▶ Station IDs can be set from STATION_ID_001 to STATION_ID_128.
- ▶ Hold down the **▲/AIR** or **RESET/▼** button on the station ID list to move 10 items up or down at a time.
- ▶ To cancel the setting, press the **DISP/ESC** button in Step 4.
- ▶ The data logger management program sold separately is required to register and edit station IDs. For information on the data logger management program, contact RIKEN KEIKI.
- ▶ If the station ID selection function is disabled in [Disp mode item] of the setup program sold separately, this setting item will no longer appear in display mode. (The default setting is enabled.)

6-4-6 Setting a Bluetooth device connection

Sets the connection to a Bluetooth device when the Bluetooth function is enabled.
 Setting this item to [ON] allows communication with a smartphone on which the dedicated app has been downloaded. The default setting is [OFF].

NOTE

- ▶ The Bluetooth device connection setting is retained even when the power is turned off.
- ▶ The Bluetooth function is optional (specified at time of order).
- ▶ RK Link (the dedicated app) can be downloaded free of charge from Google Play or App Store.
- ▶ By default, the Bluetooth function automatically turns [OFF] if no communication occurs for five minutes while the function is turned [ON]. This setting can be altered using the data logger management program sold separately.
- ▶ If the BLE connection function is disabled in [Disp mode item] of the setup program sold separately, this setting item will no longer appear in display mode. (The default setting is enabled.)

1 Press the DISP/ESC button several times on the measurement mode screen to display the BLUETOOTH screen.

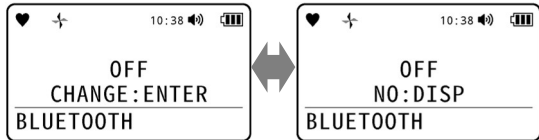

2 Press the POWER/ENTER button.
 If you do not wish to set, press the DISP/ESC button.

3 Press the ▲/AIR or RESET/▼ button to select [ON] or [OFF].

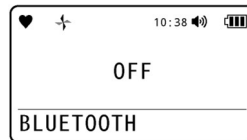

4 Press the POWER/ENTER button.

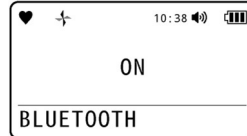

The Bluetooth device connection is set.
 [SETTING] appears followed by [END], and the display returns to the screen in Step 1.

NOTE

- ▶ To cancel the setting, press the DISP/ESC button in Step 4.

6-4-7 Setting the buzzer volume

Selects the buzzer volume setting.

The volume can be selected as [HIGH] or [LOW]. The default setting is [HIGH].

NOTE

- ▶ The buzzer volume setting is retained even when the power is turned off.
- ▶ If the buzzer volume adjustment function is disabled in [Disp mode item] of the setup program sold separately, this setting item will no longer appear in display mode. (The default setting is enabled.)

- 1 Press the DISP/ESC button several times on the measurement mode screen to display the BUZZER VOLUME screen.

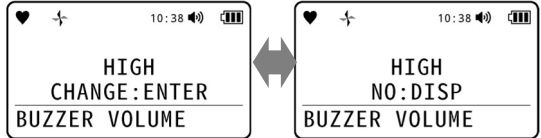

- 2 Press the POWER/ENTER button.
If you do not wish to set, press the DISP/ESC button.

- 3 Press the ▲/AIR or RESET/▼ button to select [HIGH] or [LOW].

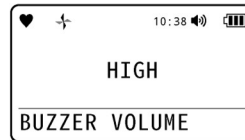

- 4 Press the POWER/ENTER button.

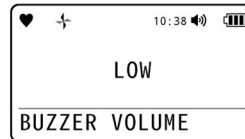

The buzzer volume is set.

[SETTING] appears followed by [END], and the display returns to the screen in Step 1.

NOTE

- ▶ To cancel the setting, press the DISP/ESC button in Step 4.

6-4-8 Switching display language to English (ATEX/IECEx model)

Returns the display language to English.

NOTE

- ▶ This can be set with the ATEX/IECEx model when a language other than English has been set. The item does not appear in display mode in other cases.
- ▶ The display language setting is retained even when the power is turned off.
- ▶ Set the display language using [LANGUAGE] in user mode. (Refer to '7-4-5 Setting the display language'.)
- ▶ If the return to English display function is disabled in [Disp mode item] of the setup program sold separately, this setting item will no longer appear in display mode. (The default setting is enabled.)

- 1 Press the DISP/ESC button several times on the measurement mode screen to display the LANGUAGE CHANGE screen.**

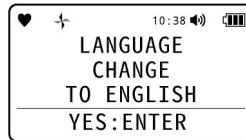

- 2 Press the POWER/ENTER button.**
If you do not wish to set, press the DISP/ESC button.

- 3 Press the POWER/ENTER button.**

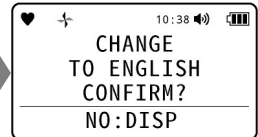
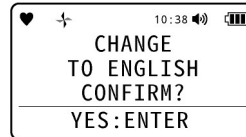

The display switches to English.

[END] appears and the display returns to the screen in Step 1.

NOTE

- ▶ To cancel the setting, press the DISP/ESC button in Step 3.

6-4-9 Switching display language to Japanese (Japan Ex model)

Returns the display language to Japanese.

NOTE

- ▶ This can be set with the Japan Ex model when a language other than Japanese has been set. The item does not appear in display mode in other cases.
- ▶ The display language setting is retained even when the power is turned off.
- ▶ Set the display language using [LANGUAGE] in user mode. (Refer to '7-4-5 Setting the display language'.)
- ▶ If the return to Japanese display function is disabled in [Disp mode item] of the setup program sold separately, this setting item will no longer appear in display mode. (The default setting is enabled.)

- 1 Press the DISP/ESC button several times on the measurement mode screen to display the LANGUAGE screen.**

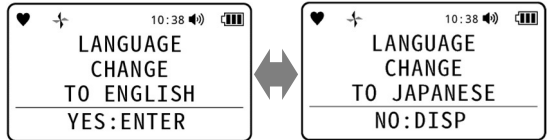

- 2 Press the POWER/ENTER button.**
If you do not wish to set, press the DISP/ESC button.

- 3 Press the POWER/ENTER button.**

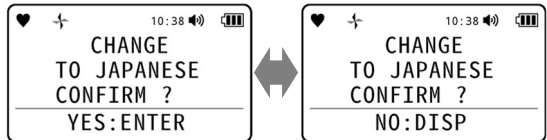

The display switches to Japanese.

[終了] (END) appears, and the display returns to the screen in Step 1.

NOTE

- ▶ To cancel the setting, press the DISP/ESC button in Step 3.

7

Settings (User Mode)

7-1 User mode display items

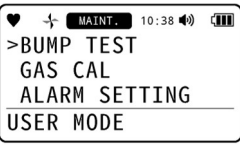
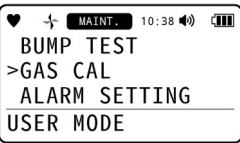
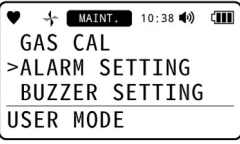
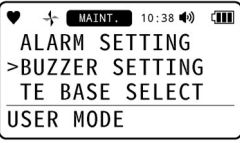
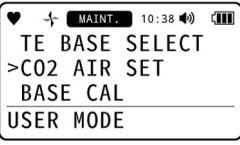
| LCD display | Details | Reference |
|--|--|---|
| <p>BUMP TEST</p>  <p>The LCD display shows the following menu items: MAINT., 10:38, a battery level indicator, and a signal strength indicator. The main menu items are: >BUMP TEST, GAS CAL, ALARM SETTING, and USER MODE. The BUMP TEST option is highlighted.</p> | <p>Performs a bump test.</p> | <p>8-3 Performing bump tests</p> |
| <p>GAS CAL</p>  <p>The LCD display shows the following menu items: MAINT., 10:38, a battery level indicator, and a signal strength indicator. The main menu items are: BUMP TEST, >GAS CAL, ALARM SETTING, and USER MODE. The GAS CAL option is highlighted.</p> | <p>Performs fresh air adjustment, CO₂ zero adjustment, base gas adjustment, and span adjustment. CO₂ zero adjustment is performed when a carbon dioxide sensor is installed. Base gas adjustment is performed when a sensor (TEF sensor) requiring base gas adjustment is installed.</p> | <p>8-2 Performing gas adjustment</p> |
| <p>ALARM SETTING</p>  <p>The LCD display shows the following menu items: MAINT., 10:38, a battery level indicator, and a signal strength indicator. The main menu items are: GAS CAL, >ALARM SETTING, BUZZER SETTING, and USER MODE. The ALARM SETTING option is highlighted.</p> | <p>Sets the gas alarm setpoints, alarm type, and alarm pattern for each sensor. Alarm setpoints can also be returned to their default settings.</p> | <p>7-3 Gas alarm settings</p> |
| <p>BUZZER SETTING</p>  <p>The LCD display shows the following menu items: MAINT., 10:38, a battery level indicator, and a signal strength indicator. The main menu items are: ALARM SETTING, >BUZZER SETTING, TE BASE SELECT, and USER MODE. The BUZZER SETTING option is highlighted.</p> | <p>Enables and disables the buzzer.</p> | <p>7-4-1 Setting the buzzer</p> |
| <p>CO2 AIR SET</p>  <p>The LCD display shows the following menu items: MAINT., 10:38, a battery level indicator, and a signal strength indicator. The main menu items are: TE BASE SELECT, >CO2 AIR SET, BASE CAL, and USER MODE. The CO2 AIR SET option is highlighted.</p> | <p>Sets whether to perform fresh air adjustment for the carbon dioxide sensor during fresh air adjustment. This is displayed when a carbon dioxide sensor is installed.</p> | <p>7-4-2 Enabling/disabling CO₂ fresh air adjustment</p> |

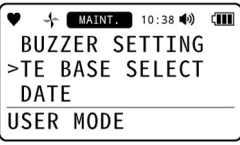
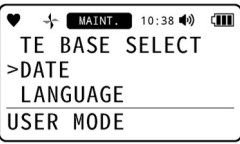
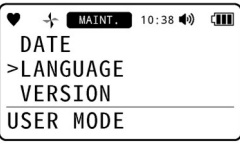
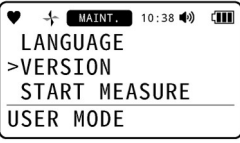
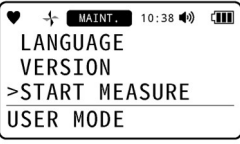
| LCD display | Details | Reference |
|--|---|---|
|  | <p>Selects the gas type used for base gas adjustment.</p> <p>This is displayed when a sensor (TEF sensor) requiring base gas adjustment is installed.</p> | <p>7-4-3 Selecting gas type for base gas adjustment</p> |
|  | <p>The internal clock date (year, month, day) and time (hours and minutes) can be set.</p> | <p>7-4-4 Setting the date and time</p> |
|  | <p>Sets the screen display language.</p> | <p>7-4-5 Setting the display language</p> |
|  | <p>Displays the version information for the modules mounted in the product.</p> | <p>7-4-6 Displaying version information</p> |
|  | <p>Switches to the measurement mode screen.</p> | |

7-2 Switching to user mode

- 1 **Turn off the power.**
Hold down the POWER/ENTER button.
- 2 **Press POWER/ENTER and ▲/AIR buttons simultaneously.**
- 3 **Release the buttons when the buzzer blips once.**
The power turns on, and the user mode menu appears.
- 4 **Press the ▲/AIR or RESET/▼ button to select the item to be set.**

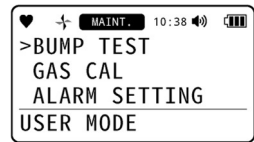

NOTE

- ▶ A password input screen is displayed after Step 3 if the user mode password setting is enabled (the default setting is disabled). Press the ▲/AIR or RESET/▼ button to select a number, then press the POWER/ENTER button to confirm. The user mode menu is displayed once the (four-digit) password has been correctly entered. The default password setting is "0000". Note that the password can be changed using the setup program sold separately.

<Switching from user mode to measurement mode>

- 1 **Press the ▲/AIR or RESET/▼ button in user mode, select [START MEASURE], then press the POWER/ENTER button.**
The product operates in the same way as when the power has just been turned on and enters measurement mode.

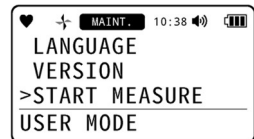

7-3 Gas alarm settings

7-3-1 Setting alarm setpoints

Alarm setpoints can be set individually for each sensor. Alarm setpoints can be set in increments corresponding to the resolution.

<R sensors>

| Sensor | Detection target gas | Resolution | Setting range lower limit (): recommended range | Setting range upper limit (): recommended range |
|----------|--|------------|---|---|
| ESR-X13P | Oxygen (O ₂) | 0.1 % | 0.0 % (19.5 % or less) | 25.0 % (23.5 % or more) |
| ESR-A13i | Hydrogen sulfide (H ₂ S) (low concentration) | 0.1 ppm | 0.5 ppm (1.0 ppm or more) | 200.0 ppm |
| ESR-A13P | Carbon monoxide (CO) | 1 ppm | 12 ppm (25 ppm or more) | 2,000 ppm |

<F sensors>

| Sensor | Detection target gas | Resolution | Setting range lower limit (): recommended range | Setting range upper limit |
|-------------|--|---|---|------------------------------|
| NCF-6322P | Methane (CH ₄) Japan Ex model Isobutane (HC (i-C ₄ H ₁₀)) Hydrogen (H ₂) Acetylene (C ₂ H ₂) | 1 %LEL | 1 %LEL (10 %LEL or more) | 60 %LEL |
| NCF-6322P M | Methane (CH ₄) ATEX/IECEX model | | | |
| TEF-7520P | Methane (CH ₄) Isobutane (HC (i-C ₄ H ₁₀)) Hydrogen (H ₂) | 0.1 vol% | 1.0 vol% (25.0 vol% or more) | 100.0 vol% |
| IRF-4341 | Methane (CH ₄) | 0.5 %LEL (0 – 100 %LEL) 0.1 vol% (100 %LEL – 100 vol%) | 0.0 %LEL (10 %LEL or more) | 60.0 %LEL |
| IRF-4345 | Isobutane (HC (i-C ₄ H ₁₀)) | 0.5 %LEL (0 – 100 %LEL) 0.1 vol% (100 %LEL – 100 vol%) | 0.0 %LEL (10 %LEL or more) | 60.0 %LEL |
| IRF-4443 | Carbon dioxide (CO ₂) | 0.01 vol% (0 – 5 vol%) 0.10 vol% (5 – 20 vol%) | 0.00 vol% (1.00 vol% or more) | 20.00 vol% |
| IRF-4433 | Carbon dioxide (CO ₂) | 20 ppm | 0 ppm (500 ppm or more) | 10,000 ppm |
| ESF-A24R2 | Hydrogen sulfide (H ₂ S) (high concentration) | 1 ppm | 20 ppm (1,000 ppm) | 1,000 ppm |
| ESF-B242 | Ammonia (NH ₃) | 0.5 ppm | 10.0 ppm (25.0 ppm or more) | 75.0 ppm |
| ESF-C930 | Chlorine (Cl ₂) | 0.01 ppm | 0.09 ppm (0.50 ppm or more) | 1.50 ppm |
| ESF-B249 | Ozone (O ₃) | 0.005 ppm | 0.035 ppm (0.100 ppm or more) | 0.600 ppm |
| ESF-A24E2 | Hydrogen chloride (HCl) | 0.05 ppm | 0.35 ppm (2.00 ppm or more) | 6.00 ppm |

| Sensor | Detection target gas | Resolution | Setting range lower limit (): recommended range | Setting range upper limit |
|-----------|--|---|---|------------------------------|
| ESF-A24D4 | Sulfur dioxide (SO ₂) | 0.1 ppm | 0.4 ppm (2.0 ppm or more) | 100.0 ppm |
| ESF-A24D | Hydrogen cyanide (HCN) Japan Ex model | 0.1 ppm | 0.9 ppm (5.0 ppm or more) | 15.0 ppm |
| ESF-A24DX | Hydrogen cyanide (HCN) ATEX/IECEX model | 0.1 ppm | 0.9 ppm (5.0 ppm or more) | 15.0 ppm |
| PIF-001 | Volatile organic compounds (VOC, 10.6 eV, ppb) | 1 ppb (0 – 4,000 ppb) 10 ppb (4,000 – 40,000 ppb) | 0 ppb (5,000 ppb or more) | 40,000 ppb |
| PIF-002 | Volatile organic compounds (VOC, 10.6 eV, ppm) | 0.1 ppm (0 – 400.0 ppm) 1 ppm (400.0 – 4,000 ppm) | 0.0 ppm (400.0 ppm or more) | 4,000 ppm |
| PIF-003 | Volatile organic compounds (VOC, 10.0 eV, ppm) | 0.01 ppm (0 – 10.00 ppm) 0.1 ppm (10.00 – 100.0 ppm) | 0.00 ppm (5.00 ppm or more) | 100.0 ppm |

NOTE

- ▶ Set the alarm setpoints as follows: First alarm ≤ second alarm (first alarm ≥ second alarm for L-H alarm type)
- ▶ Use the product with the alarms set to within a range compatible with product performance. Alarm setpoints below the recommended range may result in false alarms.
- ▶ The recommended range for the ESR-X13P (O₂) applies when it is used as an oxygen deficiency gauge (L alarm). For oxygen concentration measurements in inert gas (H alarm), the recommended range is 5.0 vol% or more.
- ▶ The alarm points with a "-" listed in the alarm set value section cannot be changed. (Refer to '4-2 Gas Alarm Points')

1 Press the ▲/AIR or RESET/▼ button in the user mode menu to select [ALARM SETTING], then press the POWER/ENTER button.

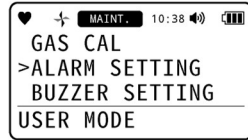

2 Check to confirm that [ALARM POINTS] is selected, then press the POWER/ENTER button.



3 Press the ▲/AIR or RESET/▼ button to select the sensor, then press the POWER/ENTER button.

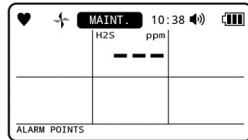

4 Press the ▲/AIR or RESET/▼ button to set the value for the first alarm setpoint, then press the POWER/ENTER button.

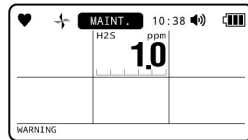

5 Press the ▲/AIR or RESET/▼ button to set the value for the second alarm setpoint, then press the POWER/ENTER button.

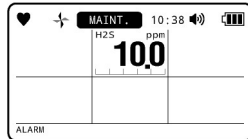

6 Press the ▲/AIR or RESET/▼ button to set the value for the STEL alarm setpoint, then press the POWER/ENTER button.

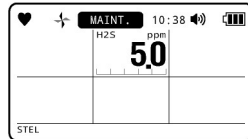

7 Press the ▲/AIR or RESET/▼ button to set the value for the TWA alarm setpoint, then press the POWER/ENTER button.

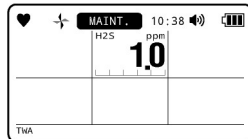

[END] appears, and the display returns to the screen in Step 3.

NOTE

- ▶ Press the ▲/AIR or RESET/▼ button when setting an alarm setpoint to change the value in increments corresponding to the resolution.
 - ▶ Hold down the ▲/AIR or RESET/▼ button (for less than seven seconds) when setting an alarm setpoint to change the value in increments corresponding to 10 times the resolution. In addition, hold down the button for seven seconds or more to change the value in increments corresponding to more than 10 times the resolution.
 - ▶ Press the DISP/ESC button when setting an alarm setpoint to return to the previous screen.
 - ▶ To cancel the setting, press the DISP/ESC button several times to display the first alarm setpoint ([WARNING]) setting screen, then press the DISP/ESC button.
 - ▶ To return to the user mode menu, press the DISP/ESC button several times to display the alarm setting menu, select [ESCAPE], then press the POWER/ENTER button.
-

7-3-2 Setting alarm type

Set the gas alarm type for each sensor.
 These can be set as [H-HH], [L-LL], or [L-H]. The default setting is [H-HH] ([L-H] for oxygen (O₂)).

NOTE

- ▶ The second alarm setpoint is automatically set to the same value as the first alarm setpoint in the following cases:
 - When changed from [H-HH] or [L-H] to [L-LL]
 - When changed from [L-LL] to [H-HH] or [L-H]

1 Press the ▲/AIR or RESET/▼ button in the user mode menu to select [ALARM SETTING], then press the POWER/ENTER button.



2 Press the ▲/AIR or RESET/▼ button to select [ALARM TYPE], then press the POWER/ENTER button.



3 Press the ▲/AIR or RESET/▼ button to select the sensor, then press the POWER/ENTER button.

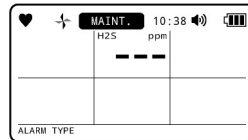

4 Press the ▲/AIR or RESET/▼ button to select an alarm type.
 Select [H-HH], [L-LL], or [L-H].

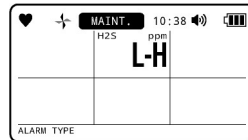
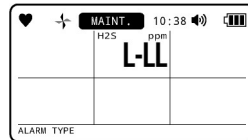
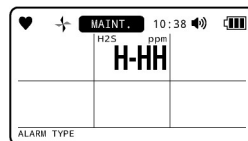

5 Press the POWER/ENTER button.
 The alarm type is set.
 [END] appears, and the display returns to the screen in Step 3.

NOTE

- ▶ To cancel the setting, press the DISP/ESC button in Step 5.
 - ▶ To return to the user mode menu, press the DISP/ESC button several times to display the alarm setting menu, select [ESCAPE], then press the POWER/ENTER button.
-

7-3-3 Setting alarm pattern

Set the alarm pattern.

This can be set to [LATCHING] or [SELF RESET]. The default setting is [LATCHING].

- 1 Press the ▲/AIR or RESET/▼ button in the user mode menu to select [ALARM SETTING], then press the POWER/ENTER button.

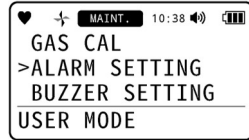

- 2 Press the ▲/AIR or RESET/▼ button to select [ALARM LATCHING], then press the POWER/ENTER button.



- 3 Press the ▲/AIR or RESET/▼ button to select [LATCHING] or [SELF RESET].



- 4 Press the POWER/ENTER button.

The alarm pattern is set.

[END] appears, and the display returns to the screen in Step 2.

NOTE

- ▶ To cancel the setting, press the DISP/ESC button in Step 4.
- ▶ To return to the user mode menu, select [ESCAPE] on the alarm setting menu, then press the POWER/ENTER button.
- ▶ If self-latching is selected, the alarm is reset when the RESET/▼ button is pressed after the gas concentration has returned to normal.
If auto reset is selected, the alarm is reset automatically once the gas concentration has returned to normal.

7-3-4 Resetting alarm setpoints

This restores alarm setpoints to their default settings.

NOTE

- ▶ This item does not appear in user mode if the sensors installed are not the default sensors.
- ▶ For more information on alarm setpoint default settings, refer to '4-2 Gas alarm setpoints'.

- 1 Press the ▲/AIR or RESET/▼ button in the user mode menu to select [ALARM SETTING], then press the POWER/ENTER button.



- 2 Press the ▲/AIR or RESET/▼ button to select [DEFAULT ALM-P], then press the POWER/ENTER button.



- 3 Press the POWER/ENTER button.
To cancel the reset, press the DISP/ESC button.

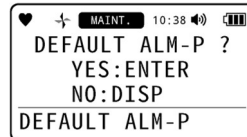

- 4 Press the POWER/ENTER button.
To cancel the reset, press the DISP/ESC button.

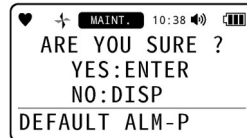

The alarm setpoints are reset.
[END] appears, and the display returns to the screen in Step 2.

NOTE

- ▶ To return to the user mode menu, select [ESCAPE] on the alarm setting menu, then press the POWER/ENTER button.

7-3-5 Enabling/disabling the alarm function

Enable and disable the alarm function.

Gas alarms will not operate when the alarm function is set to [OFF]. The [NO ALARM] icon is also displayed at the top of the screen.

The default setting is [ON].

- 1 Press the ▲/AIR or RESET/▼ button in the user mode menu to select [ALARM SETTING], then press the POWER/ENTER button.

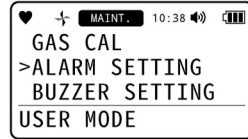

- 2 Press the ▲/AIR or RESET/▼ button to select [ALARM ON], then press the POWER/ENTER button.



- 3 Press the ▲/AIR or RESET/▼ button to select [ON] or [OFF].

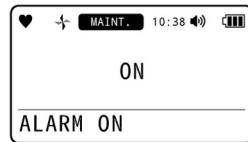

- 4 Press the POWER/ENTER button.

The alarm function is set.

[END] appears, and the display returns to the screen in Step 2.

NOTE

- ▶ To cancel the setting, press the DISP/ESC button in Step 4.
- ▶ To return to the user mode menu, select [ESCAPE] on the alarm setting menu, then press the POWER/ENTER button.

7-4 Other user mode settings

7-4-1 Setting the buzzer

Set the buzzer.

Select one of the following: The default setting is [ALL ON].

- [ALL ON]: The buzzer sounds in all situations. (Button operation tone, alarm tone, and warning tone sound.)
- [ALL OFF]: The buzzer does not sound except for certain system abnormalities (ROM, RAM, FRAM). (Button operation tone, alarm tone, and warning tone are muted)
- [BUTTON TONE OFF]: Only the button operation tone is muted. (Alarm tone and warning tone sound.)

NOTE

- ▶ The buzzer always sounds for ROM, RAM, and FRAM abnormalities, regardless of the buzzer setting.

- 1 Press the **▲/AIR** or **RESET/▼** button in the user mode menu to select **[BUZZER SETTING]**, then press the **POWER/ENTER** button.



- 2 Press the **▲/AIR** or **RESET/▼** button to select a buzzer setting.
Select [ALL ON], [ALL OFF], or [BUTTON TONE OFF].

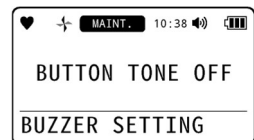
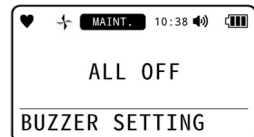

- 3 Press the **POWER/ENTER** button.
The buzzer is set.
[END] appears, and the display returns to the screen in Step 1.

NOTE

- ▶ To cancel the setting, press the **DISP/ESC** button in Step 3.

7-4-2 Enabling/disabling CO₂ fresh air adjustment

Sets whether to perform fresh air adjustment for the carbon dioxide sensor during fresh air adjustment. When this item is set to [ON], fresh air adjustment for the carbon dioxide sensor is performed during fresh air adjustment. The default setting is [OFF].

NOTE

- ▶ This can be set only when a carbon dioxide sensor is installed. The item does not appear in user mode in other cases.
- ▶ When fresh air adjustment is performed with the CO₂ fresh air adjustment setting enabled, the carbon dioxide sensor will be automatically set to 400 ppm for the air sucked in and not the actual carbon dioxide concentration. Caution is required here, as this state no longer satisfies the normal product specifications.
To set the carbon dioxide sensor to 0 ppm, perform CO₂ zero adjustment. (Refer to '8-2-3 Performing CO₂ zero adjustment'.)
- ▶ Do not enable the CO₂ fresh air adjustment setting when VOC sensors are installed. Correct adjustment will not be possible due to the carbon dioxide (CO₂) generated by the activated carbon filter CF-8350.

- 1 Press the ▲/AIR or RESET/▼ button in the user mode menu to select [CO₂ AIR SET], then press the POWER/ENTER button.



- 2 Press the ▲/AIR or RESET/▼ button to select [ON] or [OFF].

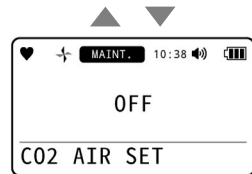

- 3 Press the POWER/ENTER button.
Whether to perform fresh air adjustment for the carbon dioxide sensor is set.
[END] appears, and the display returns to the screen in Step 1.

NOTE

- ▶ To cancel the setting, press the DISP/ESC button in Step 3.

7-4-3 Selecting gas type for base gas adjustment

Selects the gas type used for base gas adjustment.
This can be set to [N2] or [INERT]. The default setting is [N2].

NOTE

- ▶ This can be set only when a sensor (TEF sensor) allowing base gas adjustment is installed. The item does not appear in user mode in other cases.
- ▶ If a TEF sensor (methane (CH₄) or isobutane (HC (i-C₄H₁₀))) type) and oxygen sensor are installed, base gas adjustment must also be performed after fresh air adjustment. (Refer to '8-2-4 Performing base gas adjustment'.)

To perform normal automatic correction of high-concentration combustible gas measurement readings using the oxygen sensor, select [N2] and perform base gas adjustment using nitrogen (N₂) after fresh air adjustment. (Refer to the '<The effects of coexisting gas on high-concentration combustible gas sensors>' note in '5-7-1 Measuring gas concentration'.)

- ▶ If a TEF sensor (methane (CH₄) or isobutane (HC (i-C₄H₁₀))) type) is installed and no oxygen sensor is installed, and a TEF sensor (hydrogen (H₂) type) is installed, fresh air adjustment is not applied. Perform only base gas adjustment. (Refer to '8-2-4 Performing base gas adjustment' and the '<The effects of coexisting gas on high-concentration combustible gas sensors>' note in '5-7-1 Measuring gas concentration'.)

When measuring in air-based environments, the effects of the oxygen concentration in the air (20.9 %) can be minimized by selecting [N2] and performing base gas adjustment using air. (Refer to the '<The effects of coexisting gas on high-concentration combustible gas sensors>' note in '5-7-1 Measuring gas concentration'.)

- 1 Press the ▲/AIR or RESET/▼ button in the user mode menu to select [TE BASE SELECT], then press the POWER/ENTER button.

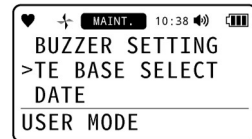

- 2 Press the ▲/AIR or RESET/▼ button to select [N2] or [INERT].

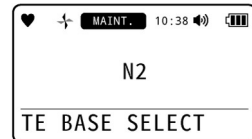

- 3 Press the POWER/ENTER button.
The gas type used for base gas adjustment is set.
[END] appears, and the display returns to the screen in Step 1.

NOTE

- ▶ To cancel the setting, press the DISP/ESC button in Step 3.

7-4-4 Setting the date and time

The internal clock date (year, month, day) and time (hours and minutes) can be set.

Set the date and time in the sequence year → month → day → hours → minutes.

- 1 Press the ▲/AIR or RESET/▼ button in the user mode menu to select [DATE], then press the POWER/ENTER button.



- 2 Press the ▲/AIR or RESET/▼ button to set an item of the date and time, then press the POWER/ENTER button.

The item currently selected blinks.

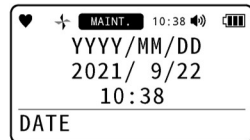

- 3 Repeat Step 2.

After setting the minutes for the time, press the POWER/ENTER button. [END] appears, and the display returns to the screen in Step 1.

NOTE

- ▶ To cancel the setting, press the DISP/ESC button in Step 2.
- ▶ Press the DISP/ESC button when setting the date (year, month, or day) or time (hours or minutes) to return to the previous screen.
- ▶ Pressing the DISP/ESC button when setting the year for the date returns to the user mode menu.

7-4-5 Setting the display language

Sets the screen display language. The default setting for the Japan Ex model is [JAPANESE]. The default setting for the ATEX/IECEx model is [ENGLISH].

The following languages are available:

- [ENGLISH]
- [JAPANESE]
- [ITALIAN]
- [SPANISH]
- [GERMAN]
- [FRENCH]
- [PORTUGUESE]
- [RUSSIAN]
- [KOREAN]
- [CHINESE(SC)] (simplified Chinese)
- [CHINESE(TC)] (traditional Chinese)
- [VIETNAMESE]
- [POLISH]
- [TURKISH]
- [SLOVAK]
- [CZECH]

- 1 Press the ▲/AIR or RESET/▼ button in the user mode menu to select [LANGUAGE], then press the POWER/ENTER button.



- 2 Press the ▲/AIR or RESET/▼ button to select a language.



- 3 Press the POWER/ENTER button. [END] appears, and the display returns to the screen in Step 1.

NOTE

- ▶ To cancel the setting, press the DISP/ESC button in Step 3.

7-4-6 Displaying version information

Displays the version information for the modules mounted in the product.

The following information can be displayed:

- Main PCB version
- Sensor PCB version
- R sensor versions
- F sensor (F1/F2/F3) versions
- Option (Bluetooth (BLE) function) version
- PID table version

NOTE

- ▶ The information for [ROM] and [SUM] in [MAIN BOARD VER] is displayed as [----] while they are being calculated.

1 Press the ▲/AIR or RESET/▼ button in the user mode menu to select [VERSION], then press the POWER/ENTER button.

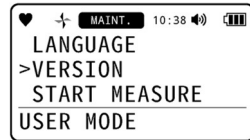

2 Press the ▲/AIR or RESET/▼ button to select the version information to be displayed.

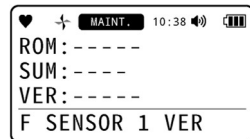
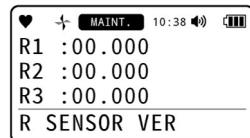
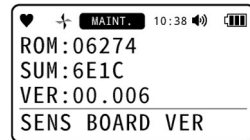
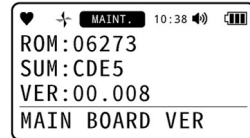

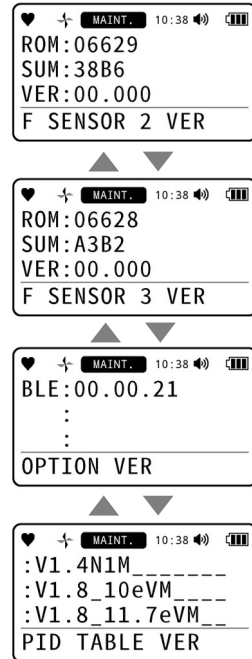

3 Press the POWER/ENTER button.

[END] appears, and the display returns to the screen in Step 1.

8

Maintenance

The product is an important safety and disaster-prevention device.

Maintain and inspect the product at regular intervals to ensure performance and to improve disaster prevention and safety reliability.

8-1 Maintenance intervals and items

The following items should be maintained regularly before using the product:

- Daily maintenance: Perform maintenance before work.
- Monthly maintenance: Perform maintenance by testing the alarms once a month.
- Regular maintenance: Perform maintenance at least once a year (ideally, at least once every six months).

| Inspection item | Inspection details | Daily maintenance | Monthly maintenance | Regular maintenance |
|-----------------------|--|-------------------|---------------------|---------------------|
| Battery level | Check to confirm that battery levels are adequate. | ○ | ○ | ○ |
| Concentration display | Check to confirm that the concentration reading is 0 (or 20.9 % on oxygen meter) after drawing in clean air. If the reading is not 0, check to confirm that no miscellaneous gases are present, then perform fresh air adjustment. | ○ | ○ | ○ |
| Main unit operation | Check the LCD display to confirm the absence of fault indication. | ○ | ○ | ○ |
| Filter | Check to confirm that the filters are not dirty. | ○ | ○ | ○ |
| Alarm test | Test the alarms and check to confirm that the alarm LED arrays and buzzer operate correctly. | — | ○ | ○ |
| Span adjustment | Perform span adjustment using a calibration gas. | — | — | ○ |
| Gas alarm check | Check the gas alarm with a calibration gas. | — | — | ○ |



WARNING

- If you encounter a product abnormality, contact RIKEN KEIKI immediately.

NOTE

- ▶ Perform span adjustment using calibration gas once every six months.
- ▶ Span adjustment requires dedicated tools and preparation of a calibration gas. Always contact RIKEN KEIKI for span adjustment.
- ▶ The built-in sensors have finite service lives and must be replaced regularly.
- ▶ If the sensors cannot be adjusted using span adjustment, the readings are not restored after fresh air adjustment, or the readings fluctuate, the sensors are at the end of their life. Contact RIKEN KEIKI. For more information on sensor warranty periods, refer to '12-8-2 Sensor warranty'.

- ▶ The dustproof and waterproof construction rating of IP66/68 (IPx8 indicates no water ingress will occur if the product is immersed to a depth of two meters for one hour) does not refer to whether or not the product is capable of detecting gas during or after exposure to the corresponding conditions. Be sure to remove any dust or water.

<Maintenance service>

RIKEN KEIKI provides services related to regular maintenance, including span adjustment, as well as other adjustments and maintenance.

Preparing calibration gas requires dedicated tools, such as gas cylinders of the specified concentration and gas sampling bags.

Our certified service engineers have expert knowledge of the dedicated tools and products. Please take advantage of the RIKEN KEIKI maintenance service to maintain safe operation of the product.

The major maintenance service items are as follows. Please contact RIKEN KEIKI for more information.

| Service | Service details |
|---|---|
| Battery level check | Checks the battery levels. |
| Concentration display check | Checks to confirm that the concentration reading is zero (20.9 % for oxygen concentration reading and 400 – 500 ppm for carbon dioxide reading) using a zero gas. Fresh air adjustment (zero adjustment) is performed if the reading is not zero. |
| Filter check | Checks the dust filter for contamination and clogging. The filter is replaced if dirty or clogged. |
| Alarm test | Alarm tests are performed to confirm that the alarm lamps and buzzer operate correctly. |
| Span adjustment | Adjusts sensitivity using a calibration gas. |
| Gas alarm check | Checks the gas alarm using a calibration gas. <ul style="list-style-type: none"> • Alarm check (Confirms alarm activation when alarm setpoint is reached.) • Delay time check (Checks delay time until alarm activation.) • Buzzer, lamps, and concentration reading check (Checks operation for each of the two-step alarms.) |
| Product cleaning and repair (visual inspection) | Checks the product exterior for dirt and cleaning/repairing of visible areas. Replaces parts that are cracked or damaged. |
| Product operation check | Operates the buttons to check function operations and parameters. |
| Consumable part replacement | Replaces degraded components such as sensors and filters. |

8-2 Performing gas adjustment

Gas adjustment requires dedicated tools and a calibration gas. Contact RIKEN KEIKI to request gas readjustment.

CAUTION

- Do not use lighter gas to check the sensitivity of the product. Constituents in lighter gas may degrade sensor performance.
- Due to the sensor characteristics, an accurate reading may not be displayed immediately after turning on the power. Allow the product to warm up for at least one minute to allow the reading to stabilize before use. Allow the product to warm up for at least 10 minutes before performing gas adjustment.

8-2-1 Preparation for gas adjustment

<Required equipment/materials>

- Calibration gas (sold separately)
- Gas sampling bag (sold separately) or demand flow valve (sold separately)*

* Used to extract gas from the gas cylinder.

<Gas supply method>

Connect the gas sampling bag or demand flow valve (and gas cylinder) as shown below to draw in the calibration gas, then adjust once the reading has risen. For information on the calibration gas type and time taken to draw in the calibration gas, refer to '<Recommended calibration gas concentration and introduction time>'.

Using a gas sampling bag

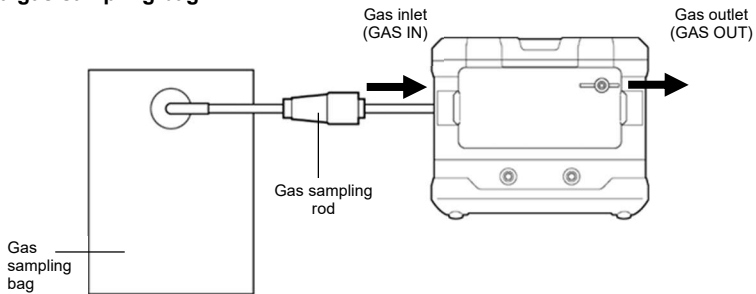

Using a demand flow valve (and gas cylinder)

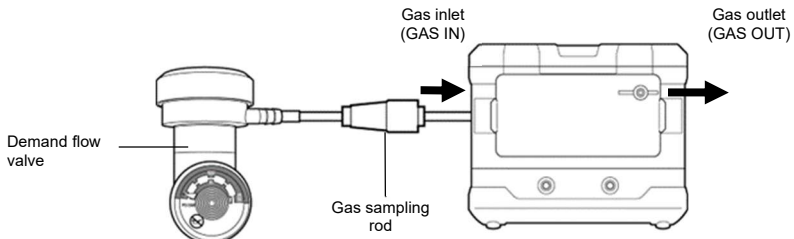

<Recommended calibration gas concentration and introduction time>**<R sensors>**

| Sensor | Detection target gas | Calibration gas | Calibration gas concentration | Gas introduction time |
|----------|--|--|-------------------------------|-----------------------|
| ESR-X13P | Oxygen (O ₂) | Oxygen (O ₂) Nitrogen (N ₂) diluted | 12.0 % | 60 seconds |
| ESR-A13i | Hydrogen sulfide (H ₂ S) (low concentration) | Hydrogen sulfide (H ₂ S) | 25.0 ppm | 60 seconds |
| ESR-A13P | Carbon monoxide (CO) | Carbon monoxide (CO) | 50 ppm | 60 seconds |

<F sensors>

| Sensor | Detection target gas | Calibration gas | Calibration gas concentration | Gas introduction time |
|-------------|---|--|---|-----------------------|
| NCF-6322P | Methane (CH ₄) Japan Ex model | Methane (CH ₄) | 50 %LEL | 60 seconds |
| | Isobutane (HC (i-C ₄ H ₁₀)) | Isobutane (HC (i-C ₄ H ₁₀)) | | |
| | Hydrogen (H ₂) | Hydrogen (H ₂) | | |
| | Acetylene (C ₂ H ₂) | Acetylene (C ₂ H ₂) | | |
| NCF-6322P M | Methane (CH ₄) ATEX/IECEx model | Methane (CH ₄) | | |
| TEF-7520P | Methane (CH ₄) | Methane (CH ₄) | 50 vol% | 60 seconds |
| | Isobutane (HC (i-C ₄ H ₁₀)) | Isobutane (HC (i-C ₄ H ₁₀)) | | |
| | Hydrogen (H ₂) | Hydrogen (H ₂) | | |
| IRF-4341 | Methane (CH ₄) | Methane (CH ₄) | 50 %LEL/80 vol% | 60 seconds |
| IRF-4345 | Isobutane (HC (i-C ₄ H ₁₀)) | Isobutane (HC (i-C ₄ H ₁₀)) | 50 %LEL/80 vol% | 60 seconds |
| IRF-4443 | Carbon dioxide (CO ₂) | Carbon dioxide (CO ₂) | 14 vol% | 60 seconds |
| IRF-4433 | Carbon dioxide (CO ₂) | Carbon dioxide (CO ₂) | 5000 ppm | 60 seconds |
| ESF-A24R2 | Hydrogen sulfide (H ₂ S) (high concentration) | Hydrogen sulfide (H ₂ S) | 25 ppm | 60 seconds |
| ESF-B242 | Ammonia (NH ₃) | Ammonia (NH ₃) | 40 ppm | 120 seconds |
| ESF-C930 | Chlorine (Cl ₂) | Chlorine (Cl ₂) | 0.80 ppm | 120 seconds |
| ESF-B249 | Ozone (O ₃) | Ozone (O ₃) or chlorine (Cl ₂) | Depends on calibration gas ^{*1} | 120 seconds |
| ESF-A24E2 | Hydrogen chloride (HCl) | Hydrogen chloride (HCl) | 3.2 ppm | 120 seconds |
| ESF-A24D4 | Sulfur dioxide (SO ₂) | Sulfur dioxide (SO ₂) | 3.2 ppm | 120 seconds |
| ESF-A24D | Hydrogen cyanide (HCN) Japan Ex model | Hydrogen cyanide (HCN) or phosphine (PH ₃) | Depends on calibration gas ^{*2} | 120 seconds |
| ESF-A24DX | Hydrogen cyanide (HCN) ATEX/IECEx model | Hydrogen cyanide (HCN) or phosphine (PH ₃) | Depends on calibration gas ^{*2} | 120 seconds |
| PIF-001 | Volatile organic compounds (VOC, 10.6 eV, ppb) | Isobutylene (C ₄ H ₈) | 20,000 ppb | 60 seconds |
| PIF-002 | Volatile organic compounds (VOC, 10.6 eV, ppm) | Isobutylene (C ₄ H ₈) | 100 ppm | 60 seconds |
| PIF-003 | Volatile organic compounds (VOC, 10.0 eV, ppm) | Isobutylene (C ₄ H ₈) | 20 ppm | 60 seconds |

*1: The gas concentration the ESF-B249 differs depending on the calibration gas used. Perform gas adjustment using either of the following gas concentrations:

When using ozone (O₃) (actual gas): 0.16 ppm
 When using chlorine (Cl₂) (replacement gas): 0.16 ÷ (conversion factor) ppm

*2: The gas concentration the ESF-A24D and the ESF-A24DX differs depending on the calibration gas used. Perform gas adjustment using either of the following gas concentrations:

When using hydrogen cyanide (HCN) (actual gas): 8 ppm
 When using phosphine (PH₃) (replacement gas): 8 ÷ (conversion factor) ppm

NOTE

- ▶ The recommended calibration gas concentration and introduction time are the same as above the bump test also.
- ▶ The figures given above are the recommended calibration gas concentrations. The concentration should be set and gas adjustment performed if different calibration gas concentrations are used.



WARNING

- Do not apply pressure to the gas sampling bag when attaching it. Otherwise this may cause the calibration gas to leak inside, preventing correct adjustment.

About the calibration gas

- Calibration gases include hazardous gases (e.g., combustible gases, toxic gases, oxygen deficiency). Take care when handling the gases and the related equipment.
- When combining hydrogen cyanide (HCN) and hydrogen sulfide (H2S), adjust the hydrogen cyanide (HCN) first, followed by the hydrogen sulfide (H2S) adjustment. The hydrogen cyanide (HCN) sensor may show an increased reading due to interference from 25 ppm of hydrogen sulfide (H2S), and it will take approximately 5 minutes to return to zero (assuming the zero suppress initial setting value is 0.9 ppm).

Gas sampling bag

- Use different gas sampling bags for each gas type and concentration to ensure accurate adjustment.

Gas adjustment location

- Do not perform gas adjustment in a confined space.
- Do not perform gas adjustment in locations where gases such as silicone and spray can gases are used.
- Perform gas adjustment in an environment as close as possible to the gas measurement environment.
- Calibration gases include hazardous gases (e.g., combustible gases, toxic gases, oxygen deficiency). Always perform adjustment in an exhaust booth or recover the calibration gas by attaching an exhaust bag to the gas outlet (GAS OUT).

Gas adjustment using a replacement gas and conversion factor

- When adjusting with a replacement gas, calculate the calibration gas concentration by multiplying the replacement gas concentration × by the conversion factor.

Example: For ESF-B249 (O₃)

Chlorine (Cl₂) (replacement gas) concentration × conversion factor = Ozone (O₃) (calibration gas) concentration

- The conversion factor is printed on the underside of the sensor.



Sensor underside



Typical label indicating replacement gas and conversion factor
(Example: Replacement gas: Chlorine (Cl₂), conversion factor: 1.9)

**CAUTION**

- Keep in mind that using a gas mixture to perform span adjustment may affect indication accuracy. This is due to interference by gases other than the target gas. Refer to '12-5 List of interference gases for electrochemical type sensors' to avoid combinations of gases that are known to cause interference.
-

<Gas adjustment menu>

Gas adjustment is performed using [GAS CAL] in user mode.

The following menu displayed in [GAS CAL] allows individual items to be run and set.

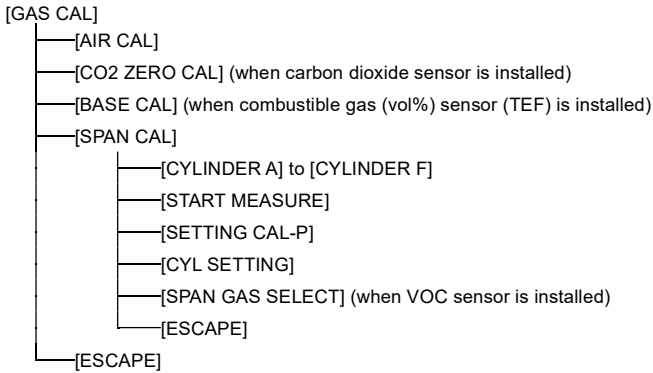

NOTE

- ▶ With the power turned off, press the POWER/ENTER button and ▲/AIR button simultaneously to switch to user mode. (Refer to '7-2 Switching to user mode'.)
- ▶ To exit [GAS CAL], press the ▲/AIR or RESET/▼ button several times to select [ESCAPE], then press the POWER/ENTER button. The display returns to the user mode menu.
- ▶ To exit [SPAN CAL], press the ▲/AIR or RESET/▼ button several times to select [ESCAPE], then press the POWER/ENTER button. The display returns to the [GAS CAL] menu.
- ▶ It is possible to enter measurement mode from [SPAN CAL]. Press the ▲/AIR or RESET/▼ button several times in [SPAN CAL] to select [START MEASURE], then press the POWER/ENTER button. User mode ends, and the product enters measurement mode after performing the same operation as when the power is turned on.



WARNING

- Return to measurement mode manually once gas adjustment ends. The product will not automatically return to measurement mode from user mode.

8-2-2 Performing fresh air adjustment

Fresh air adjustment must be performed before measuring gas concentration.

For information on individual sensor adjustment methods and precautions, refer to '5-6 Performing fresh air adjustment in measurement mode'.

NOTE

<GX-9000H>

- ▶ Perform fresh air adjustment separately in H₂S high concentration measurement mode and H₂S low concentration measurement mode. Press the ▲/AIR and RESET/▼ buttons simultaneously. The buzzer blips once, and the product switches between H₂S high concentration measurement mode and H₂S low concentration measurement mode.

- 1 Press the ▲/AIR or RESET/▼ button in the user mode menu to select [GAS CAL], then press the POWER/ENTER button.

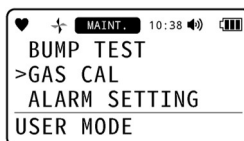

- 2 Press the ▲/AIR or RESET/▼ button in the [GAS CAL] menu to select [AIR CAL], then press the POWER/ENTER button.

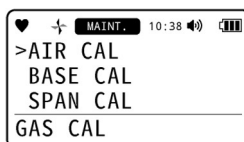

- 3 Hold down the ▲/AIR button.

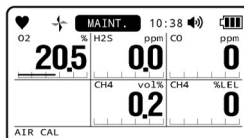

Fresh air adjustment is performed.

Keep the ▲/AIR button pressed for as long as the screen shown on the right is displayed.

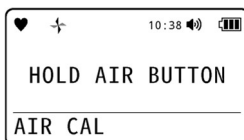

- 4 Release the ▲/AIR button once [RELEASE] appears on the screen.



Once fresh air adjustment has been successfully completed, the result is displayed, and the concentration after fresh air adjustment is then displayed.

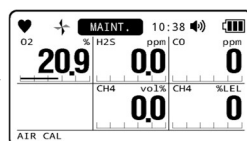
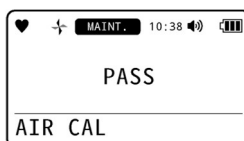

The display returns to the screen in Step 2.

NOTE

- ▶ If fresh air adjustment fails, [FAIL] appears in the gas concentration display area for the failed sensor. Press the RESET/▼ button to reset the fault alarm (adjustment failure). Fresh air adjustment will not be performed on the sensor for which fresh air adjustment failed, and the current gas concentration is displayed.
 - ▶ If fresh air adjustment fails, repeat fresh air adjustment in clean air. If fresh air adjustment still fails, the sensor is likely to be faulty. Contact RIKEN KEIKI.
-

8-2-3 Performing CO₂ zero adjustment

CO₂ zero adjustment must be performed if a carbon dioxide sensor is installed.

CO₂ zero adjustment can be performed by using either nitrogen (N₂) for the calibration gas or the CF-284 CO₂ removal filter.

WARNING

- Carbon dioxide (CO₂) is present in the air at a concentration of between approximately 400 and 500 ppm. Correct gas concentration measurements are not possible if CO₂ zero adjustment is performed in air without the CF-284 CO₂ removal filter.

CAUTION

- Do not draw in carbon dioxide (CO₂) during CO₂ zero adjustment.
- Do not breathe into the gas inlet during CO₂ zero adjustment.

NOTE

- ▶ If no sensors requiring CO₂ zero adjustment are installed, [CO₂ ZERO CAL] will not appear in the user mode [GAS CAL] menu.

<When using nitrogen (N₂) for the calibration gas>

When using nitrogen (N₂) for the calibration gas, introduce via GAS IN for approximately 60 seconds.

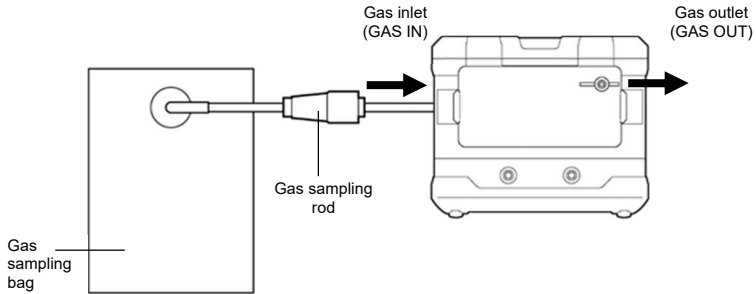

<When using the CF-284 CO₂ removal filter>

If nitrogen (N₂) is not used for the calibration gas, the CF-284 CO₂ removal filter must be used to remove carbon dioxide (CO₂) from the air. Attach the CF-284 CO₂ removal filter with the arrow on the side pointing toward the gas inlet (GAS IN) of the main unit, then draw in air for approximately 60 seconds before starting CO₂ zero adjustment.

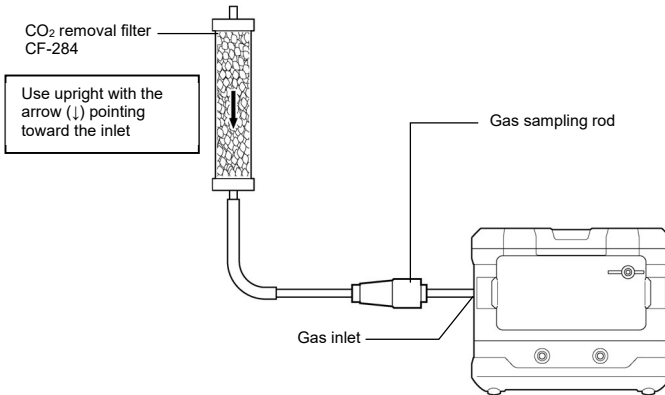

CAUTION

- Use the CO₂ removal filter held upright. Drawing in air with the filter horizontal may allow air to pass through the top of the CO₂ removal filter cylinder, preventing carbon dioxide (CO₂) in the air from being absorbed.
- After using the CO₂ removal filter, seal it from the air. The absorbing agent will absorb carbon dioxide (CO₂) from the air if left exposed to air, reducing absorbency.
- Store the CO₂ removal filter in a dry location not exposed to direct sunlight.

NOTE

- ▶ The number of times a CO₂ removal filter can be used depends on the concentration of carbon dioxide in the air. It also depends on the airtightness of the filter and the storage temperature and humidity.
- ▶ The following table gives guideline figures for the number of uses when used to draw in air for one minute at a time. Provide a margin of error in cases in which the environmental concentration of carbon dioxide cannot be determined.

| Carbon dioxide concentration in measurement environment | Expected number of uses |
|---|-------------------------|
| 500 ppm | Approx. 1,000 times |
| 1,000 ppm | Approx. 500 times |
| 2,000 ppm | Approx. 200 times |
| 4,000 ppm | Approx. 100 times |

1 Press the ▲/AIR or RESET/▼ button in the user mode menu to select [GAS CAL], then press the POWER/ENTER button.

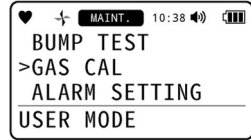

2 Press the ▲/AIR or RESET/▼ button in the [GAS CAL] menu to select [CO2 ZERO CAL], then press the POWER/ENTER button.

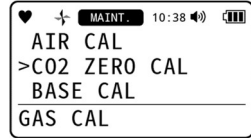

3 Introduce nitrogen (N₂), wait 60 seconds, then press the POWER/ENTER button.

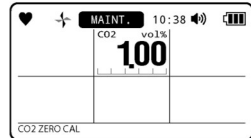

CO₂ zero adjustment is performed.



Once CO₂ zero adjustment has been successfully completed, the result is displayed, and the concentration after CO₂ zero adjustment is then displayed.

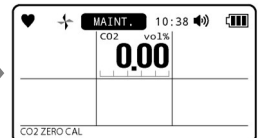
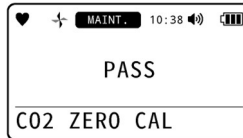

The display returns to the screen in Step 2.

NOTE

- ▶ If CO₂ zero adjustment fails, [FAIL] appears in the gas concentration display area for the carbon dioxide sensor.
Press the RESET/▼ button to reset the fault alarm (adjustment failure). CO₂ zero adjustment will not be performed if CO₂ zero adjustment failed, and the current gas concentration is displayed.
- ▶ To cancel CO₂ zero adjustment, press the DISP/ESC button in Step 3.
- ▶ When fresh air adjustment is performed with the CO₂ fresh air adjustment setting enabled, the carbon dioxide sensor will be automatically set to 400 ppm for the air sucked in and not the actual carbon dioxide concentration. (Refer to '7-4-2 Enabling/disabling CO₂ fresh air adjustment'.) Caution is required here, as this state no longer satisfies the normal product specifications.
To set the carbon dioxide sensor to 0 ppm, perform CO₂ zero adjustment.

8-2-4 Performing base gas adjustment

If a TEF sensor is installed, base gas adjustment must be performed after fresh air adjustment.



- Use nitrogen (N₂) or inert gas (assumed as nitrogen (N₂): 86 vol%, carbon dioxide (CO₂): 14 vol%) for the calibration gas for base gas adjustment.
- If a TEF sensor (methane (CH₄) or isobutane (HC (i-C₄H₁₀)) type) and oxygen sensor are installed, base gas adjustment must also be performed after fresh air adjustment.

To perform normal automatic correction of high-concentration combustible gas measurement readings using the oxygen sensor, select [N2] for the base gas adjustment gas (refer to '7-4-3 Selecting gas type for base gas adjustment') and perform base gas adjustment using nitrogen (N₂) after fresh air adjustment. (Refer to the '<The effects of coexisting gas on high-concentration combustible gas sensors>' note in '5-7-1 Measuring gas concentration'.)

- If a TEF sensor (methane (CH₄) or isobutane (HC (i-C₄H₁₀)) type) is installed and no oxygen sensor is installed, and a TEF sensor (hydrogen (H₂) type) is installed, fresh air adjustment is not applied. Perform only base gas adjustment. (Refer to the '<The effects of coexisting gas on high-concentration combustible gas sensors>' note in '5-7-1 Measuring gas concentration'.)

Note that drawing in air after base gas adjustment will cause the zero point to drift as follows:

| TEF sensor specifications | Gas used for base gas adjustment | |
|--|----------------------------------|----------------|
| | Nitrogen (N ₂) | Inert gas* |
| TEF sensor (methane (CH ₄) type) | 1.5 – 2.6 vol% | 0.6 – 1.6 vol% |
| TEF sensor (isobutane (HC (i-C ₄ H ₁₀)) type) | 1.4 – 4.5 vol% | 1.0 – 3.3 vol% |
| TEF sensor (hydrogen (H ₂) type) | 0.2 – 0.6 vol% | 1.2 – 1.6 vol% |

* Inert gas is assumed to be nitrogen (N₂): 86 vol%, carbon dioxide (CO₂): 14 vol%

However, the readings may not fluctuate even when air is introduced after base gas adjustment, as TEF sensor readings do not fluctuate around zero up to 0.9 vol% due to the zero suppression function (default setting: enabled). (Refer to '12-3 Zero suppression function'.)

When measuring in air-based environments, the effects of the oxygen concentration in the air (20.9 %) can be minimized by selecting [N2] as the gas for base gas adjustment (refer to '7-4-3 Selecting gas type for base gas adjustment') and performing base gas adjustment using air. (Refer to the '<The effects of coexisting gas on high-concentration combustible gas sensors>' note in '5-7-1 Measuring gas concentration'.)

NOTE

- ▶ The calibration gas used for base gas adjustment can be set using [TE BASE SELECT] in user mode. (Refer to '7-4-3 Selecting gas type for base gas adjustment'.)
- ▶ If no sensors requiring base gas adjustment are installed, [BASE CAL] will not appear in the user mode [GAS CAL] menu.

- 1 Press the ▲/AIR or RESET/▼ button in the user mode menu to select [GAS CAL], then press the POWER/ENTER button.

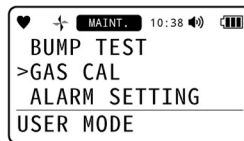

- 2 Press the ▲/AIR or RESET/▼ button in the [GAS CAL] menu to select [BASE CAL], then press the POWER/ENTER button.

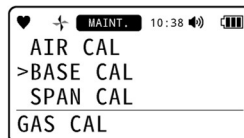

- 3 Introduce the base gas adjustment gas, wait 120 seconds, then press the POWER/ENTER button. For the gas type used for base gas adjustment, use the gas (nitrogen (N₂) or inert gas) selected for [TE BASE SELECT] in user mode.

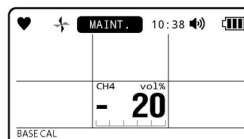

Base gas adjustment is performed.

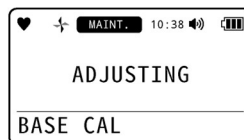

Once base gas adjustment has been successfully completed, the result is displayed, and the concentration after base gas adjustment is then displayed.

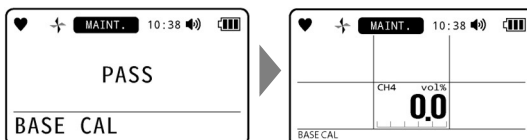

The display returns to the screen in Step 2.

NOTE

- ▶ If base gas adjustment fails, [FAIL] appears in the gas concentration display area for the failed TEF sensor. Press any button other than ▲/AIR to reset the fault alarm (adjustment failure). Base gas adjustment will not be performed on the TEF sensor for which base gas adjustment failed, and the current gas concentration is displayed.
- ▶ To cancel base gas adjustment, press the DISP/ESC button in Step 3.

8-2-5 Setting span adjustment

The cylinders, calibration gas concentration, and calibration gas can be set for span adjustment.

<Setting the cylinders>

Set the sensor groups (cylinders) for calibration. When using cylinders with mixtures of multiple gases, gas adjustment can be performed simultaneously for the gases set to the same cylinder. Set based on the cylinders used.

<GX-9000>

Cylinders A to F can be set.

<GX-9000H>

The following settings are available for each sensor:

| Sensor | Cylinder setting range |
|--------|------------------------|
| R1 | A to F |
| R2 | A to C |
| R3 | A to C |
| F1 | D to F |
| F2 | D to F |
| F3 | A to C |

The default cylinder settings are as follows:

| Sensor slot | Sensor model | Detection target gas | Default cylinder setting |
|-------------|--|--|--|
| R1 | ESR-X13P | Oxygen (O ₂) | A |
| R2 | ESR-A13i | Hydrogen sulfide (H ₂ S) low concentration | B (Japan Ex model) A (ATEX/IECEx model) |
| R3 | ESR-A13P | Carbon monoxide (CO) | A |
| F1 | IRF-4443 | Carbon dioxide (CO ₂) | D |
| | IRF-4433 | Carbon dioxide (CO ₂) | |
| | ESF-A24R2 | Hydrogen sulfide (H ₂ S) high concentration | |
| | ESF-B242 | Ammonia (NH ₃) | |
| | ESF-C930 | Chlorine (Cl ₂) | |
| | ESF-B249 | Ozone (O ₃) | |
| | ESF-A24E2 | Hydrogen chloride (HCl) | |
| | ESF-A24D4 | Sulfur dioxide (SO ₂) | |
| | ESF-A24D | Hydrogen cyanide (HCN) Japan Ex models | |
| | ESF-A24DX | Hydrogen cyanide (HCN) ATEX/IECEx models | |
| | PIF-001 | Volatile organic compounds (VOC, 10.6 eV, ppb) | |
| | PIF-002 | Volatile organic compounds (VOC, 10.6 eV, ppm) | |
| PIF-003 | Volatile organic compounds (VOC, 10.0 eV, ppm) | | |
| F2 | TEF-7520P | Methane (CH ₄), isobutane (HC (i-C ₄ H ₁₀)), hydrogen (H ₂) | E |
| | IRF-4341 | Methane (CH ₄) | E (range [H]) A (range [L]) |
| | IRF-4345 | Isobutane (HC (i-C ₄ H ₁₀)) | |
| F3 | NCF-6322P | Methane (CH ₄) Japan Ex model, isobutane (HC (i-C ₄ H ₁₀)) | A |
| | | Hydrogen (H ₂), acetylene (C ₂ H ₂) | C |
| | NCF-6322P M | Methane (CH ₄) ATEX/IECEx model | A |
| | IRF-4443 | Carbon dioxide (CO ₂) | C |
| | IRF-4433 | Carbon dioxide (CO ₂) | C |

1 Press the ▲/AIR or RESET/▼ button in the user mode menu to select [GAS CAL], then press the POWER/ENTER button.

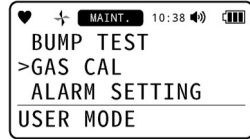

2 Press the ▲/AIR or RESET/▼ button in the [GAS CAL] menu to select [SPAN CAL], then press the POWER/ENTER button.

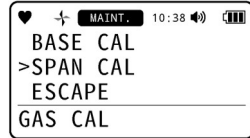

3 Press the ▲/AIR or RESET/▼ button to select [CYL SETTING], then press the POWER/ENTER button.



4 Press the ▲/AIR or RESET/▼ button to select the sensor, then press the POWER/ENTER button.

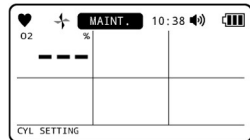

5 Press the ▲/AIR or RESET/▼ button to set the sensor, then press the POWER/ENTER button.

Press the button repeatedly to cycle through the following settings [A] → [B] → [C] ... [F].
Note that cylinders that cannot be set will not be displayed.

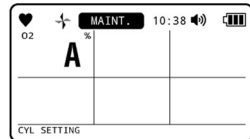

[END] appears, and the display returns to the screen in Step 4.

NOTE

- ▶ To cancel the setting, press the DISP/ESC button in Step 5.
- ▶ With a double-range IRF sensor (methane (CH₄), isobutane (HC (i-C₄H₁₀))) that allows adjustment for both high and low concentrations, [H] or [L] can be selected when the sensor is selected.

<High concentration>

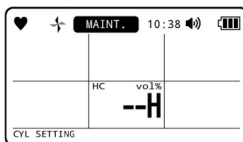

<Low concentration>

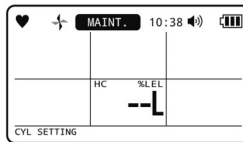

- ▶ With a double-range IRF sensor (methane (CH₄), isobutane (HC (i-C₄H₁₀))) that allows adjustment for both high and low concentrations, the same cylinder cannot be set for both high and low concentrations.

<Setting the gas concentration for span adjustment>

The calibration gas concentration for span adjustment can be set within the following ranges for each sensor.

Gas concentration can be set in increments corresponding to the resolution.

<R sensors>

| Sensor | Detection target gas | Resolution | Setting range lower limit | Setting range upper limit |
|----------|--|------------|---------------------------|---------------------------|
| ESR-X13P | Oxygen (O ₂) | 0.1 % | 0.0 % | 18.0 % |
| ESR-A13i | Hydrogen sulfide (H ₂ S) (low concentration) | 0.1 ppm | 1.0 ppm | 200.0 ppm |
| ESR-A13P | Carbon monoxide (CO) | 1 ppm | 15 ppm | 2,000 ppm |

<F sensors>

| Sensor | Detection target gas | Resolution | Setting range lower limit | Setting range upper limit |
|-------------|---|---|---------------------------|---------------------------|
| NCF-6322P | Methane (CH ₄) Japan Ex model Isobutane (HC (i-C ₄ H ₁₀)) Hydrogen (H ₂) Acetylene (C ₂ H ₂) | 1 %LEL | 5 %LEL | 75 %LEL |
| NCF-6322P M | Methane (CH ₄) ATEX/IECEx model | | | |
| TEF-7520P | Methane (CH ₄) Isobutane (HC (i-C ₄ H ₁₀)) Hydrogen (H ₂) | 0.1 vol% | 5.0 vol% | 100.0 vol% |
| IRF-4341 | Methane (CH ₄) | 0.5 %LEL/0.1 vol% | 0.0 %LEL/ 0.0 vol% | 100.0 %LEL/ 100.0 vol% |
| IRF-4345 | Isobutane (HC (i-C ₄ H ₁₀)) | 0.5 %LEL/0.1 vol% | 0.0 %LEL/ 0.0 vol% | 100.0 %LEL/ 100.0 vol% |
| IRF-4443 | Carbon dioxide (CO ₂) | 0.01 vol% (0 – 5 vol%) 0.10 vol% (5 – 20 vol%) | 0.0 vol% | 20.00 vol% |
| IRF-4433 | Carbon dioxide (CO ₂) | 20 ppm | 0.0 ppm | 10,000 ppm |
| ESF-A24R2 | Hydrogen sulfide (H ₂ S) (high concentration) | 1 ppm | 20 ppm | 1,000 ppm |
| ESF-B242 | Ammonia (NH ₃) | 0.5 ppm | 10.0 ppm | 75.0 ppm |
| ESF-C930 | Chlorine (Cl ₂) | 0.01 ppm | 0.09 ppm | 1.50 ppm |
| ESF-B249 | Ozone (O ₃) | 0.005 ppm | 0.035 ppm | 0.600 ppm |
| ESF-A24E2 | Hydrogen chloride (HCl) | 0.05 ppm | 0.35 ppm | 6.00 ppm |
| ESF-A24D4 | Sulfur dioxide (SO ₂) | 0.1 ppm | 0.4 ppm | 100.0 ppm |
| ESF-A24D | Hydrogen cyanide (HCN) Japan Ex model | 0.1 ppm | 0.9 ppm | 15.0 ppm |
| ESF-A24DX | Hydrogen cyanide (HCN) ATEX/IECEx model | 0.1 ppm | 0.9 ppm | 15.0 ppm |
| PIF-001 | Volatile organic compounds (VOC, 10.6 eV, ppb) | 1 ppb (0 – 4,000 ppb) 10 ppb (4,000 – 40,000 ppb) | 0 ppb | 40,000 ppb |
| PIF-002 | Volatile organic compounds (VOC, 10.6 eV, ppm) | 0.1 ppm (0 – 400.0 ppm) 1 ppm (400.0 – 4,000 ppm) | 0.0 ppm | 4,000 ppm |
| PIF-003 | Volatile organic compounds (VOC, 10.0 eV, ppm) | 0.01 ppm (0 – 10.00 ppm) 0.1 ppm (10.00 – 100.0 ppm) | 0.00 ppm | 100.0 ppm |

- 1 Press the ▲/AIR or RESET/▼ button in the user mode menu to select [GAS CAL], then press the POWER/ENTER button.

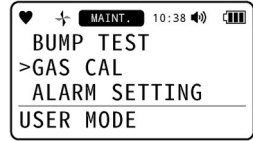

- 2 Press the ▲/AIR or RESET/▼ button in the [GAS CAL] menu to select [SPAN CAL], then press the POWER/ENTER button.



- 3 Press the ▲/AIR or RESET/▼ button to select [SETTING CAL-P], then press the POWER/ENTER button.



- 4 Press the ▲/AIR or RESET/▼ button to select the sensor, then press the POWER/ENTER button.

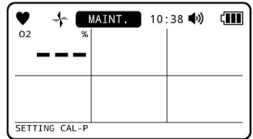

- 5 Press the ▲/AIR or RESET/▼ button to set the gas concentration for span adjustment, then press the POWER/ENTER button.

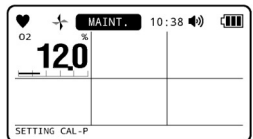

The display returns to the screen in Step 4.

NOTE

- ▶ Press the ▲/AIR or RESET/▼ button when setting the gas concentration for span adjustment to change the value in increments corresponding to the resolution.
- ▶ Hold down the ▲/AIR or RESET/▼ button (for less than seven seconds) when setting the gas concentration for span adjustment to change the value in increments corresponding to 10 times the resolution. In addition, hold down the button for seven seconds or more to change the value in increments corresponding to more than 10 times the resolution.
- ▶ To cancel the setting, press the DISP/ESC button in Step 5.
- ▶ With a double-range IRF sensor (methane (CH₄), isobutane (HC (i-C₄H₁₀))) that allows adjustment for both high and low concentrations, [H] or [L] can be selected when the sensor is selected.

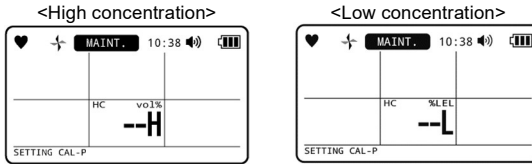

- ▶ The recommended calibration gas concentrations for use in span adjustment are described in '8-2-1 Preparation for gas adjustment'.

<Setting the calibration gas span adjustment>

Set the calibration gas used span adjustment.

The calibration gas can be set when a VOC sensor or sensor for which a replacement gas has been set (ozone (O₃) or hydrogen cyanide (HCN) sensor) is installed.

The gas that can be selected for a VOC sensor are the gas set in the volatile organic compound (VOC) conversion setting and isobutylene (C₄H₈).

For information on volatile organic compound (VOC) conversion settings, refer to '6-4-3 Volatile organic compound (VOC) conversion gas selection'.

NOTE

- ▶ If a VOC sensor or sensor for which a replacement gas has been set (ozone (O₃) or hydrogen cyanide (HCN) sensor) is not installed, [SPAN GAS SELECT] will not appear in the user mode [SPAN CAL] menu.

- 1 Press the ▲/AIR or RESET/▼ button in the user mode menu to select [GAS CAL], then press the POWER/ENTER button.
- 2 Press the ▲/AIR or RESET/▼ button in the [GAS CAL] menu to select [SPAN CAL], then press the POWER/ENTER button.
- 3 Press the ▲/AIR or RESET/▼ button to select [SPAN GAS SELECT], then press the POWER/ENTER button.
- 4 Press the ▲/AIR or RESET/▼ button to select the sensor, then press the POWER/ENTER button.
- 5 Press the ▲/AIR or RESET/▼ button to select the calibration gas for span adjustment, then press the POWER/ENTER button.

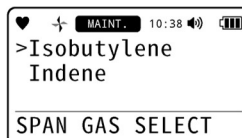
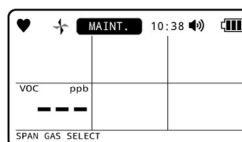
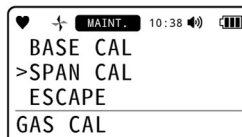
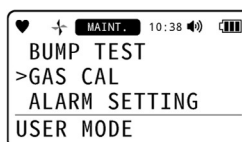

[END] appears, and the display returns to the screen in Step 4.

NOTE

- ▶ To cancel the setting, press the DISP/ESC button in Step 5.

8-2-6 Performing span adjustment

Gas adjustment can be performed for the gas types selected from cylinders A to F. Prepare the gases for gas adjustment beforehand. (Refer to '8-2-1 Preparation for gas adjustment'.)

 **CAUTION**

- Keep in mind that using a gas mixture to perform span adjustment may affect indication accuracy. This is due to interference by gases other than the target gas. Refer to '12-5 List of interference gases for electrochemical type sensors' to avoid combinations of gases that are known to cause interference.

NOTE

- ▶ Fresh air adjustment must always be performed before performing span adjustment.
- ▶ CO₂ zero adjustment or fresh air adjustment (if enabled in '7-4-2 Enabling/disabling CO₂ fresh air adjustment') must always be performed before span adjustment if a carbon dioxide sensor is installed.
- ▶ The calibration gas concentration, cylinders, and calibration gas can be set for span adjustment. (Refer to '8-2-5 Setting span adjustment'.)
- ▶ When the automatic start after successful adjustment function is enabled and the cylinder setting is A only, measurement will start automatically after a successful span adjustment.
The automatic start after successful adjustment function can be modified using the setup program sold separately.

1 Press the ▲/AIR or RESET/▼ button in the user mode menu to select [GAS CAL], then press the POWER/ENTER button.

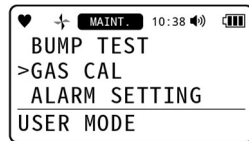

2 Press the ▲/AIR or RESET/▼ button in the [GAS CAL] menu to select [SPAN CAL], then press the POWER/ENTER button.

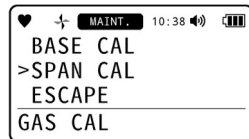

3 Press the ▲/AIR or RESET/▼ button to select the cylinder to be adjusted, then press the POWER/ENTER button.
Pressing the button cycles through the settings in the following sequence: [CYLINDER A] → [CYLINDER B] → ... [CYLINDER F].
Note that cylinders not set will not be displayed.

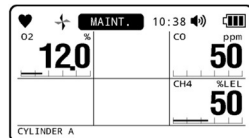

- 4 Introduce the calibration gas for span adjustment, wait 60 seconds, then press the POWER/ENTER button.

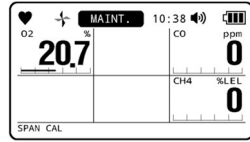

Span adjustment is performed.

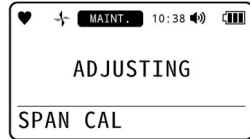

Once span adjustment has been successfully completed, the result is displayed, and the concentration after span adjustment is then displayed.

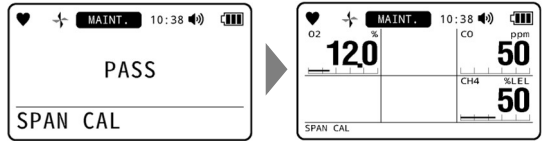

The display returns to the screen in Step 3.

NOTE

- ▶ If span adjustment fails, [FAIL] appears in the gas concentration display area for the failed sensor. Press any button other than ▲/AIR to reset the fault alarm (adjustment failure). Span adjustment will not be performed on the sensor for which span adjustment failed, and the current gas concentration is displayed.
- ▶ If the reserve value display setting is enabled, the reserve value will appear after the gas concentration.
- ▶ To cancel span adjustment, press the DISP/ESC button in Step 4.

8-3 Performing bump tests

The product includes a function for performing bump tests.

Bump tests can be performed for gas types selected from cylinders A to F.

Prepare the bump test gas in the same way as for gas adjustment, and connect it to the main unit. (Refer to '8-2-1 Preparation for gas adjustment'.)

Bump tests are performed using [BUMP TEST] in user mode.

NOTE

- ▶ With the power turned off, press the POWER/ENTER button and ▲/AIR button simultaneously to switch to user mode. (Refer to '7-2 Switching to user mode'.)
- ▶ To exit [BUMP TEST], press the ▲/AIR or RESET/▼ button several times to select [ESCAPE], then press the POWER/ENTER button. The display returns to the user mode menu.
- ▶ It is possible to enter measurement mode from [BUMP TEST]. Press the ▲/AIR or RESET/▼ button several times in [BUMP TEST] to select [START MEASURE], then press the POWER/ENTER button. User mode ends, and the product enters measurement mode after performing the same operation as when the power is turned on.
- ▶ Use the specified calibration gas for each sensor to perform bump tests.
For VOC sensors, this will be isobutylene (C_4H_8), a volatile organic compound (VOC).
- ▶ When the automatic start after successful bump test function is enabled and the cylinder setting is A only, measurement will start automatically after a successful bump test.
The automatic start after successful bump test function can be modified using the setup program sold separately.
- ▶ The default settings for conditions for executing a bump test are as follows:
 - Test time: 30 seconds
 - Tolerance (%): 50 %
 - Adjustment time: 90 seconds
 - Bump adjustment: ON
- ▶ The following conditions for executing a bump test can be modified using the setup program sold separately.
 - Tolerance (%): Threshold for checking the calibration gas
 - Gases other than oxygen (O_2): Adjustment concentration \pm (adjustment concentration \times tolerance (%))
 - Oxygen (O_2): Adjustment concentration \pm (difference between adjustment concentration and $20.9\% \times$ tolerance (%))
 - Adjustment time after test failure: Adjustment time - test time

- 1 Press the ▲/AIR or RESET/▼ button in the user mode menu to select [BUMP TEST], then press the POWER/ENTER button.

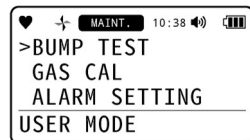

- 2 Press the ▲/AIR or RESET/▼ button to select the cylinder to be adjusted, then press the POWER/ENTER button.

Pressing the button cycles through the settings in the following sequence: [CYLINDER A] → [CYLINDER B] → ... [CYLINDER F].

Note that cylinders not set will not be displayed.

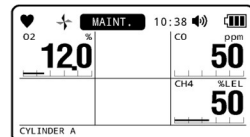

- 3 Introduce the bump test gas, then press the POWER/ENTER button.

The bump test is performed.

The bump test remaining time is displayed at the bottom of the screen.

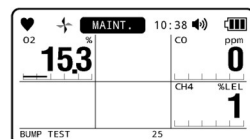

If the bump adjustment function is enabled, the product will automatically perform gas adjustment in the event of a bump test failure. The gas adjustment remaining time is displayed at the bottom of the screen.

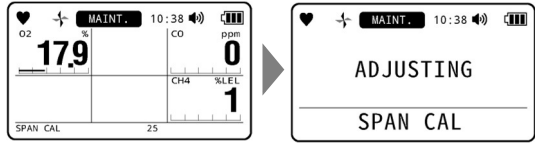

The following results are displayed when the bump test and gas adjustment have ended. Press the ▲/AIR or RESET/▼ button to toggle the results display.

- Bump test and gas adjustment results
The bump test results are displayed on the left side of the concentration display area, and the gas adjustment results are displayed on the right side.
[P]: Passed, [F]: Failed

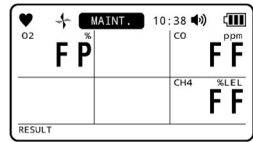

- Bump test gas concentration

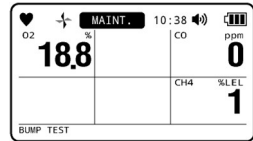

- Gas adjustment gas concentration (when gas adjustment was performed)

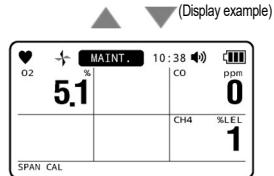

(Display example)

4 Press the POWER/ENTER button.
[END] appears, and the display returns to the screen in Step 2.

NOTE

- ▶ If the setting to perform gas adjustment after a bump test failed is disabled (the default setting is enabled), the bump test result is displayed when the bump test ends. In this case, only the bump test result and bump test gas concentration are displayed.
- ▶ To cancel a bump test, press the DISP/ESC button in Step 3.
- ▶ If a bump test fails, perform gas adjustment. If gas adjustment also fails, refer to '10 Troubleshooting'.

WARNING

- Return to measurement mode manually once the bump test is complete. The product will not automatically return to measurement mode from user mode.

8-4 Performing alarm tests

Press the POWER/ENTER button while an alarm setpoint is displayed in the display mode alarm setpoint display to test the corresponding alarm.

- 1 Press the DISP/ESC button several times on the measurement mode screen to display the ALARM POINTS screen.
- 2 Press the POWER/ENTER button.

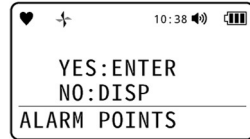

- 3 Press the ▲/AIR button several times to display the alarm setpoint for the alarm test.

Pressing the ▲/AIR button cycles through the alarm setpoints displayed.

The display changes in the following sequence:

[FULL SCALE] → [WARNING] → [ALARM] → [STEL] → [TWA] → [FULL SCALE] → ...

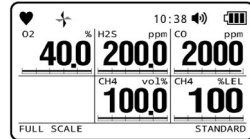

- 4 Press the POWER/ENTER button.

This activates the selected alarm setpoint alarm.

Press the RESET/▼ button to reset the alarm.

NOTE

- ▶ Perform alarm tests at regular intervals.

8-5 Cleaning procedure

Clean the product if it becomes excessively dirty. Be sure to turn off the power before cleaning, and wipe clean using a rag or cloth soaked in water and firmly wrung out.

Do not clean using water, organic solvents or commercially available cleaners for cleaning, as these may cause the product to malfunction.



CAUTION

- When wiping the product clean, do not splash water on it or use organic solvents like alcohol and benzene or commercially available cleaners. These may discolor or damage the surface of the product, or cause the sensor to malfunction.

NOTE

- ▶ Water may remain in the buzzer sound opening or grooves after the product has got wet. Remove any moisture as follows:
 - ① Wipe off any moisture on the product using a dry towel or cloth.
 - ② Hold the product firmly and shake about 10 times with the buzzer sound opening facing downward.
 - ③ Use a towel or cloth to wipe up all moisture drained from the interior.
 - ④ Place the product on a dry towel or cloth and allow to stand at room temperature.

8-6 Parts replacement

8-6-1 Periodic replacement parts

The consumable parts of the product are listed below. Consumable parts should be replaced using the recommended replacement intervals as a guide.

NOTE

- ▶ The recommended replacement intervals are guidelines only. Replacement intervals may vary depending on actual operating conditions. These intervals do not constitute warranty periods. Replacement intervals may vary depending on the results of regular maintenance.

<Recommended replacement parts list>

| Name | Recommended maintenance interval | Recommended replacement interval | Quantity (per unit) | Remarks |
|---|----------------------------------|------------------------------------|---------------------|---|
| Activated carbon filter CF-A1CP | 3 months | 6 months | ×1 | Used when carbon monoxide sensor (ESR-A13P) is installed Internal filter Part No.: 4777 9213 10 |
| Humidity control filter CF-A13i | 3 months | 6 months | ×1 | Used when hydrogen sulfide sensor (ESR- A13i) is installed Internal filter Part No.: 4777 9214 80 |
| Activated carbon filter CF-8350 | 6 months | 1 year | ×1 | Used when VOC sensor is installed External filter Part No.: 4383 9299 50 |
| CO ₂ removal filter CF-284 | 6 months | 1 year | ×1 | Used when carbon dioxide sensor is installed External filter Part No.: 4383 0390 80 |
| Dust filter (For gas sampling rod, set of 10) | 6 months | 6 months to 1 year | ×1 | Internal filter Part No.: 4181 5452 30 |
| Dust filter (For absorbent cotton filter CF-8385 and With flow monitor Filter tube, set of 10) | 6 months | 6 months to 1 year | ×1 | Internal filter Part No.: 4775 5381 60 |
| Absorbent cotton (For absorbent cotton filter CF-8385, 25 g) | 6 months | 6 months to 1 year | 1.3 g | Internal filter Part No.: 1879 0011 10 |
| Dust filter (internal filter) | 6 months | 6 months to 1 year | ×1 | Internal filter Part No.: 4777 4495 90 |
| Tubes (internal pipes) | - | 3 to 8 years | 1 set | |
| Rubber seals | - | 3 to 6 years | 1 set | |
| Pump unit assembly | 6 months | 1 to 2 years | ×1 or ×2 | GX-9000: ×1 GX-9000H: ×2 Part No.: 4777 9480 00 |
| Lithium ion battery unit (BUL-9000) | - | 500 charge/ discharge cycles | ×1 | When using lithium ion battery unit (BUL-9000) Part No.: 2931 0884 50 |

| Name | Recommended maintenance interval | Recommended replacement interval | Quantity (per unit) | Remarks |
|-----------------------|----------------------------------|----------------------------------|---------------------|---|
| AA alkaline batteries | - | - | ×6 | When using alkaline dry battery unit (BUD-9000) Part No.: 2753 3007 80 |

<Sensor replacement intervals>

| Sensor model | Detection target gas | Display range | Recommended sensor replacement interval |
|--------------|--|--|---|
| NC-6322 | Methane (CH ₄) Japan Ex model *1 | 0 – 100 %LEL | 3 years |
| | Isobutane (HC (i-C ₄ H ₁₀)) Hydrogen (H ₂) Acetylene (C ₂ H ₂) | | |
| NC-6322 M | Methane (CH ₄) ATE/IECEX model | | |
| TE-7520 | Methane (CH ₄) Isobutane (HC (i-C ₄ H ₁₀)) Hydrogen (H ₂) | 0 – 100.0 vol% | 3 years |
| IRF-4341 | Methane (CH ₄) | 0 – 100.0 %LEL/ 100.0 %LEL – 100.0 vol% | 5 years |
| IRF-4345 | Isobutane (HC (i-C ₄ H ₁₀)) | | |
| IRF-4443 | Carbon dioxide (CO ₂) | 0 – 20.00 vol% | |
| IRF-4433 | Carbon dioxide (CO ₂) | 0 – 10,000 ppm | |
| ESR-X13P | Oxygen (O ₂) | 0 – 40.0 % | 3 years |
| ESR-A13i | Hydrogen sulfide (H ₂ S) low concentration | 0 – 200.0 ppm | 3 years |
| ESR-A13P | Carbon monoxide (CO) | 0 – 2,000 ppm | 3 years |
| ESF-A24R2 | Hydrogen sulfide (H ₂ S) high concentration | 0 – 1,000 ppm | 3 years |
| ESF-B242 | Ammonia (NH ₃) | 0 – 75.0 ppm | 2 years |
| ESF-C930 | Chlorine (Cl ₂) | 0 – 1.50 ppm | 3 years |
| ESF-B249 | Ozone (O ₃) | 0 – 0.600 ppm | 1 year |
| ESF-A24E2 | Hydrogen chloride (HCl) | 0 – 6.00 ppm | 3 years |
| ESF-A24D4 | Sulfur dioxide (SO ₂) | 0 – 100.0 ppm | 3 years |
| ESF-A24D | Hydrogen cyanide (HCN) Japan Ex model | 0 – 15.0 ppm | 3 years |
| ESF-A24DX | Hydrogen cyanide (HCN) ATEX/IECEX model | 0 – 15.0 ppm | 3 years |
| PID-001 | Volatile organic compounds (VOCs) | 0 – 40,000 ppb | 4 years*2 |
| PID-002 | Volatile organic compounds (VOCs) | 0 – 4,000 ppm | 4 years*2 |
| PID-003 | Volatile organic compounds (VOCs) | 0 – 100.0 ppm | 4 years*2 |

*1: ATEX/IECEX specification has been changed from NCF-6322P to NCF-6322P M since 2025/5 shipments. The NCF-6322P is installed in earlier products, but when replacing the ATEX/IECEX-specification sensor, please make arrangements for replacement NCF-6322P M not NCF-6322P.

*2: Excluding consumable parts (LEDs, pellets). The recommended replacement interval for LEDs and pellets is one year. Depending on the usage frequency and environment, replacement may be required after several months.

NOTE

- ▶ A function check by a qualified service engineer is required after sensor replacement. To ensure safety and the stable operation of the product, request checking by a qualified service engineer. Contact RIKEN KEIKI.
- ▶ Depending on the target gas, the gas sensitivity of VOC sensors may be reduced if the sensor interior becomes dirty. In such cases, the pellet must be replaced and the LED cleaned. (Refer to '8-6-3 VOC sensor maintenance'.)
If gas sensitivity is not restored even after cleaning, replace both the LED and the pellet.

8-6-2 Gas sampling rod dust filter replacement

The gas sampling rod probe contains a dust filter. The dust filter may become dirty and clogged with use. Replace periodically based on operating conditions.

Be sure to replace the filter, particularly if water is aspirated, the flow rate drops, or the filter appears especially dirty.

- 1 Rotate the gas sampling rod probe to remove it.**

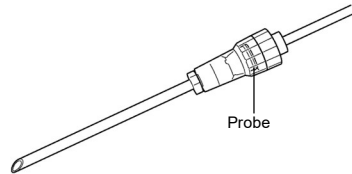

- 2 Remove the dust filter, and replace with a new one.**

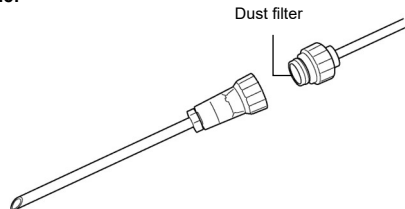

- 3 Rotate the probe to attach it.**

NOTE

- ▶ Do not use filters other than those specified by RIKEN KEIKI.
- ▶ The gas sampling rod dust filter differs from the filter cylinder dust filter. Use the respective specified filters.
- ▶ For more information on the replacement filters, refer to '8-6-1 Periodic replacement parts'.

8-6-3 Replacing of the main unit's filter/sensor

The unit contains sensors (R sensor and F sensor) and filters inside. Please replace them regularly according to the usage conditions. For the replacement cycle, refer to "8-6-1 Regular Replacement Parts."

- 1 Remove the four screws securing the main unit cover and take off the sensor cover.

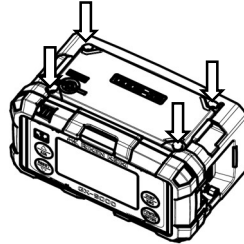

- 2 Remove the filter/sensor.

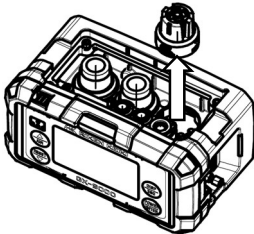

For the F sensor, remove the sensor.

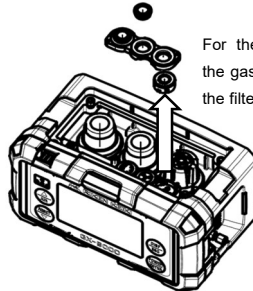

For the R sensor, remove the gasket and then remove the filter/sensor.

* The F sensor can be further disassembled in some models. Please refer to the notes for details.

- 3 Install the filter/sensor and secure the cover by tightening the four screws.

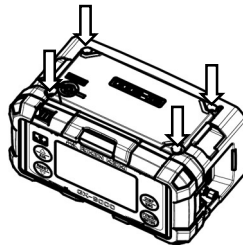

注記

- ▶ The NCF sensor, TEF sensor, and PIF sensor are divided into the sensor section and the digital attachment section. The sensor section detects the gas, while the digital attachment section processes the signals from the sensor and transmits the information to the GX-9000 main unit. The sensor section is a regular replacement part, while the digital attachment section is a repair part.

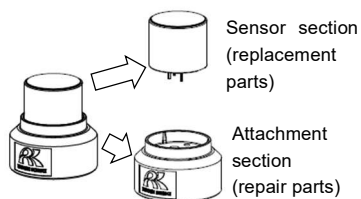

| Sensor model | Sensor section | Attachment section |
|--------------|----------------|--------------------|
| NCF-6322P | NC-6322 | NCF-B1P |
| NCF-6322P M | NC-6322 M | |
| TEF-7520P | TE-7520 | TEF-B1P |
| PIF-001 | PID-001 | PIF-B1P |
| PIF-002 | PID-002 | |
| PIF-003 | PID-003 | |

The IRF sensor and ESF sensor are integrated units, and all parts are treated as replacement parts.



Next, the procedure for replacing the dust filter is described.

- 1 Loosen the two screws on the bottom of the battery unit used for attaching and detaching the battery unit.

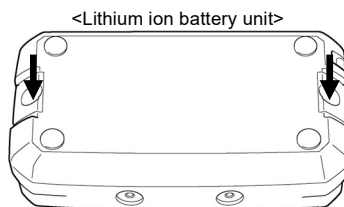
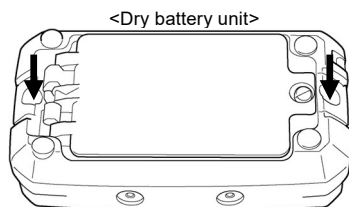

2 Remove the battery unit.

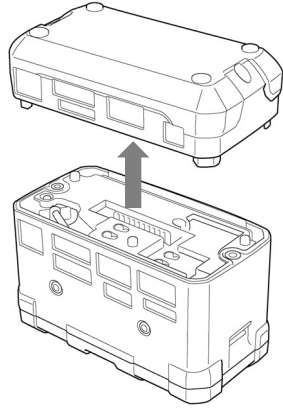

* The diagram illustrates the lithium ion battery unit.

3 Rotate the filter nipple counterclockwise to remove it.

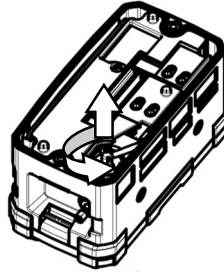

4 Remove the tube from the filter nipple.

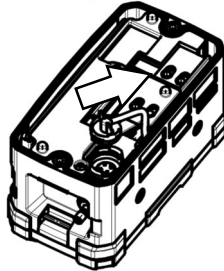

5 Remove the packing and dust filter from the filter section.

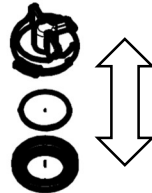

- 6 Place the dust filter on the packing and attach it to the filter nipple.

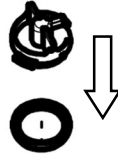

- 7 Attach the tube to the filter nipple.

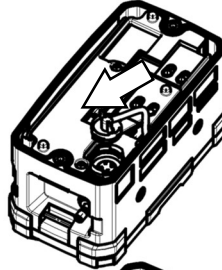

- 8 Turn the filter section clockwise to secure it.

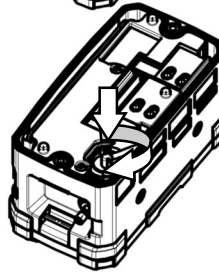

- 9 Tighten the two screws on the bottom of the main unit to secure the battery unit.

8-6-4 With flow monitor Filter tube dust filter replacement

In the case of hydrogen (H₂) type, the design is such that the operation of the pressure sensor be switched off so that a flow abnormality due to a decrease in pressure is not triggered when high concentrations of H₂ are suctioned. The filter tube with flow monitor of optional accessory allows you to check that suction is being provided by the product.

The dust filter is built into the inner part of the filter tube. The dust filter may become dirty and clogged with use. Replace periodically based on operating conditions.

Be sure to replace the filter, particularly if water is aspirated, the flow rate drops, or the filter appears especially dirty.

- 1 Turn the cap (M thread) of the filter tube with flow monitor to remove it.

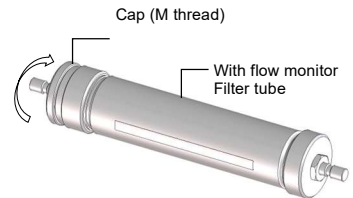

- 2 At the cap (M thread), remove the O-ring, then remove the dust filter and replace it with a new one.

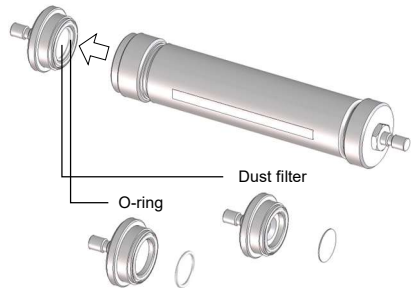

- 3 Turn the cap (M thread) to attach it to the filter tube with flow monitor.

NOTE

- ▶ Do not use filters other than those specified by RIKEN KEIKI.
- ▶ The gas sampling rod dust filter differs from the filter cylinder dust filter. Use the respective specified filters.
- ▶ For more information on the replacement filters, refer to '8-6-1 Periodic replacement parts'.

8-6-5 VOC sensor maintenance

Depending on the target gas, the gas sensitivity of VOC sensors may be reduced if the sensor interior becomes dirty. In such cases, the pellet must be replaced and the LED cleaned.

NOTE

- ▶ If gas sensitivity is not restored even after cleaning, replace both the LED and the pellet.
- ▶ Be sure to perform gas adjustment after cleaning.

<Removing the VOC sensor>

- 1 **Unscrew the four screws that secure the cover on the top of the main unit.**

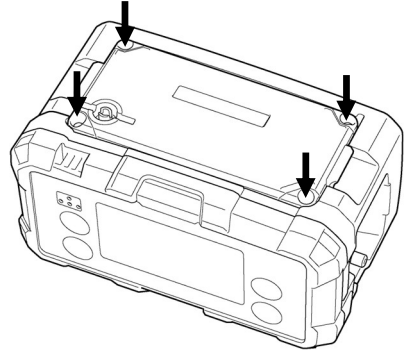

- 2 **Remove the cover and take out the VOC sensor.**
Grasp the cylindrical part of the sensor and gently pull out.

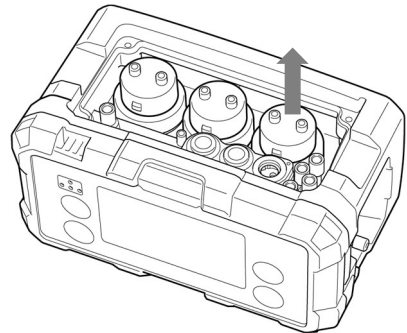

<Removing the pellet and LED>

Use the pellet removal tool to remove the pellet and LED from the VOC sensor main unit.

- 1 Place the VOC sensor main unit on a clean surface, with the bottom facing down.
- 2 Fit the pellet removal tool in the side slots of the VOC sensor.

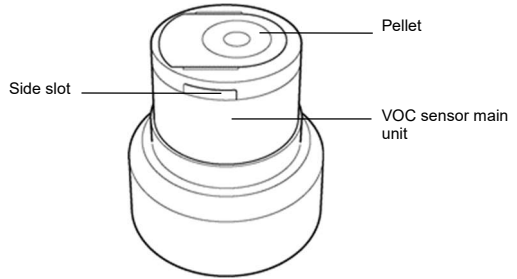
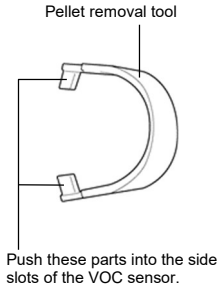

- 3 Press the pellet removal tool on both sides to lift the pellet and LED from the VOC sensor main unit.

Pushing the pellet removal tool into the side slots on the VOC sensor main unit will lift the pellet to allow removal. Press down lightly with your hand when removing to prevent the pellet from flying out. If the LED remains inside the VOC sensor main unit, use tweezers or other instrument to remove it.

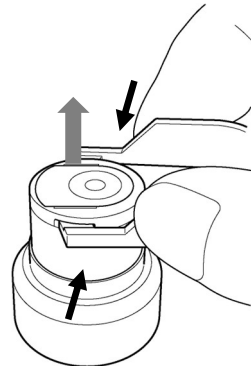

- 4 Place the pellet and LED on a clean surface. Separate the pellet removal tool from the VOC sensor.

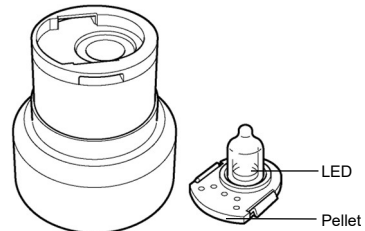

NOTE

- ▶ The small spring at the base of the LED may come off as the pellet and LED are removed from the VOC sensor main unit. If this occurs, return the LED to the VOC sensor main unit, then use tweezers or other instrument to remove the LED once again.

<Cleaning the LED>



CAUTION

- Use clean cotton swabs to clean the LED. Avoid touching the tip of the cotton swab used to clean the LED with your fingers. Oil from your fingers may soil the LED if you touch the tip of the cotton swab.
-

1 Place a small amount of alumina polishing powder on a clean cotton swab.

2 Clean the LED window with the cotton swab until you hear a squeaking sound (within about 15 seconds).

Clean the LED window in a circular motion, applying gentle pressure.

Avoid touching the LED window with your fingers while doing this.

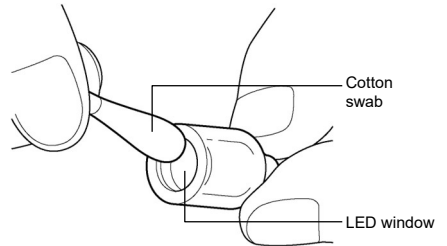

3 Use a clean cotton swab to remove any remaining alumina polishing powder from the LED window.

4 Confirm that the LED is completely dry and that no visible soiling remains.

<Mounting the pellet and LED>

Attach the LED to a new pellet and insert into the VOC sensor main unit.

**CAUTION**

- Never reattach a damaged LED to a pellet.

- 1 Place a new pellet on a clean, flat surface.**

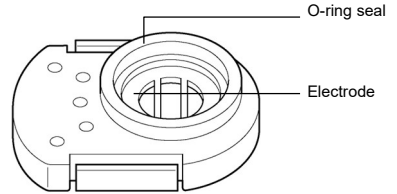

- 2 Insert the LED into the O-ring seal of the new pellet.**
When inserting the LED into the pellet, twist slightly. The LED window will fit into the electrode on the pellet.

- 3 Twist the LED into the O-ring seal so that it is closely attached to the electrode plane of the pellet.**
Check to confirm that the LED window is closely attached to the electrode plane of the pellet.

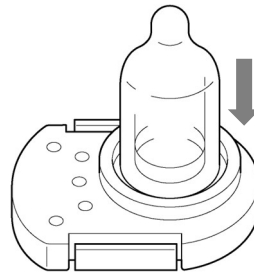

- 4 Place the pellet into which the LED has been fitted on a flat surface. Place the VOC sensor main unit over it and press so that the pellet fits into the VOC sensor main unit.**
Press in firmly until you hear a click.

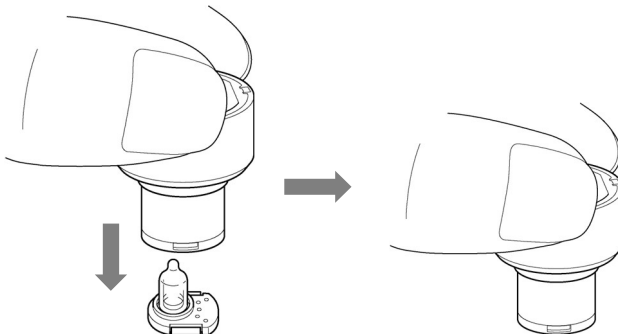

<Installing the VOC sensor>

Install the VOC sensor in the main unit and perform gas adjustment.

- 1 Remove the cover from the top of the main unit and attach the VOC sensor.**

Grasp the cylindrical part of the sensor to fit to the main unit.

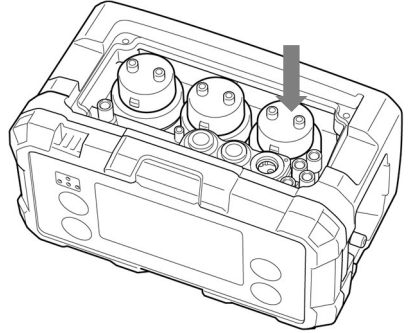

- 2 Use the four screws to secure the cover on the top of the main unit.**

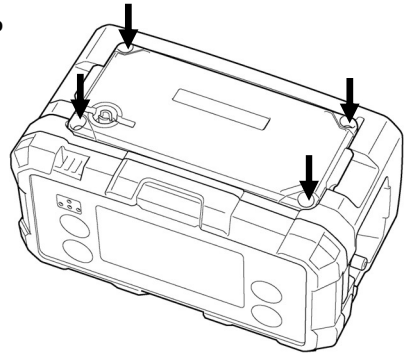

- 3 Perform gas adjustment.**

9

Storage and Disposal

9-1 Procedures for storage or when not in use for extended periods

The product must be stored in the following environment:

- In a dark place at normal temperatures and humidity and away from direct sunlight
- In a location free of gases, solvents, and vapor

Store the product in its shipping carton if this has been retained.

If the shipping carton is not available, store away from dust and dirt.



CAUTION

- Store the product with the lithium ion battery unit or dry battery unit attached.
The product constantly draws power for the sensors and clock even when the power is turned off. The sensors may be damaged or the clock display may become offset if there is no power supply.
- When using the dry battery unit, store the product with the dry batteries left inside. The product constantly requires power for the sensors even when the power is turned off.
- Even if you do not intend to use the product for extended periods, turn the power on at least once every six months to check pump suction for approximately three minutes. Grease inside the pump motor may solidify and prevent operation unless the product is operated.

NOTE

- ▶ If the lithium ion battery is stored on its own, we recommend storing after it has been discharged until the battery level icon shows one bar. Storing while fully charged may reduce battery life and accelerate battery deterioration.
 - ▶ If the dry battery unit is stored on its own, remove the batteries before storing.
-

9-2 Procedures for use after storage

Perform gas adjustment if the product is used again after an extended period in storage.



CAUTION

- After storage without use, be sure to perform gas adjustment before resuming use. Contact RIKEN KEIKI to request readjustment of the product, including gas adjustment.
- If there is a temperature difference of 15 °C or more between the storage and usage locations, turn on the power and allow the product to stand for about 10 minutes in a similar environment to the usage location to acclimatize before performing fresh air adjustment in clean air.

9-3 Product disposal

Dispose of the product as industrial waste (incombustible) in accordance with local regulations.



WARNING

- Never disassemble the sensor. Electrochemical type sensors in particular contain hazardous electrolyte. Contact with electrolyte may result in skin inflammation. Contact with eyes may result in blindness. Contact with clothing may result in discoloration or damage to the fabric. If contact occurs, rinse the area immediately with plenty of water.
- Dispose of batteries in accordance with the procedures specified by the local authority.

<Disposal in EU member states>

- Waste Electrical and Electronic Equipment (WEEE) directive



The symbol on the product shown on the left indicates that the product and its individual parts must not be disposed of with general or household waste, and must be sorted and disposed of appropriately.

Proper disposal will help prevent potential negative effects on human health and the environment.

To ensure proper treatment, collection, and recycling of the product at the time of its disposal, please use the return and collection system available in your country. For more information on collecting and recycling used products, please contact the dealer or supplier from whom you purchased the product.

- Battery regulations



The symbol on the product or battery shown on the left indicates that batteries must be disposed of separately from general or household waste.

To ensure proper treatment, collection, and recycling of batteries at the time of their disposal, please dispose of them properly using the collection system available in your country.

10

Troubleshooting

This troubleshooting section does not address causes of all problems that may occur with the product. It provides brief explanations to assist in determining the causes of common problems.

If you encounter symptoms not addressed here or if problems persist even after taking corrective action, contact RIKEN KEIKI.

10-1 Product abnormalities

<Power source related problems>

| Symptom/display | Cause | Action |
|---|--|--|
| The power cannot be turned on. | <ul style="list-style-type: none"> The battery is depleted. | Lithium ion battery unit: Charge in a safe place. Dry battery unit: Replace with new dry batteries (all six) in a safe place. |
| | <ul style="list-style-type: none"> The POWER/ENTER button was pressed for too short a time. | Hold down the POWER/ENTER button until the buzzer blips once. |
| | <ul style="list-style-type: none"> The battery unit is incorrectly attached. | Check to confirm that the battery unit is correctly attached to the main unit. |
| Abnormal operation | <ul style="list-style-type: none"> Effects of sudden static electricity noise, etc. | Turn off the power, then turn it back on again to restart. |
| The product does not operate. | <ul style="list-style-type: none"> Effects of sudden static electricity noise, etc. | Remove the battery unit in a safe place, reattach the battery unit, then turn on the power again. |
| The product cannot be recharged. (When using lithium ion battery unit) | <ul style="list-style-type: none"> The adapter is not correctly connected. | Insert the AC plug and connection terminal of the AC adapter correctly. |
| | <ul style="list-style-type: none"> There is a fault in the charging circuit. | Contact RIKEN KEIKI. |

<Flow rate abnormality (FAIL FLOW)>

| Cause | Action |
|--|--|
| <ul style="list-style-type: none"> The flow passage is blocked. | Fix the problem (e.g., broken pipe, water aspiration), then press the RESET/▼ button to restart the pump. |
| <ul style="list-style-type: none"> The pump is deteriorated. | The pump must be replaced. Contact RIKEN KEIKI. |
| <ul style="list-style-type: none"> The power was turned on in cold temperatures or after extended periods without use | Turn the power off and on several times. The pump may start working. |
| <ul style="list-style-type: none"> Left for extended periods under cold conditions | The pump valve has frozen, reducing the suction flow rate. Press the RESET/▼ button to restart the pump. The product may need to be restarted several times to restore functionality. |

<Low battery voltage abnormality (FAIL BATTERY)>

| Cause | Action |
|---|--|
| <ul style="list-style-type: none"> The battery level is low. | Lithium ion battery unit: Charge in a safe place. Dry battery unit: Replace with new dry batteries (all six) in a safe place. |

<System abnormality (FAIL SYSTEM)>

| Fault No. | Cause | Action |
|-----------|---|---|
| 000 | <ul style="list-style-type: none"> Internal ROM abnormality Effects of abnormal noise | Contact RIKEN KEIKI. |
| 010 | <ul style="list-style-type: none"> Internal RAM abnormality Effects of abnormal noise | Contact RIKEN KEIKI. |
| 021 | <ul style="list-style-type: none"> Internal FRAM abnormality Effects of abnormal noise | Contact RIKEN KEIKI. |
| 031 | <ul style="list-style-type: none"> Internal flash abnormality Data logger writing failed Effects of abnormal noise | Gas concentration measurement is possible in this state, but the data logger function cannot be used. If this symptom occurs frequently, the flash memory must be replaced. Contact RIKEN KEIKI. |
| 080 | <ul style="list-style-type: none"> Main PCB reference voltage abnormality or pressure sensor power supply voltage abnormality Effects of abnormal noise | Turn off the power, then turn it back on again to restart. If the problem persists, contact RIKEN KEIKI. |
| 081 | <ul style="list-style-type: none"> Sensor PCB communication abnormality, status abnormality, or reference voltage abnormality Effects of abnormal noise | Turn off the power, then turn it back on again to restart. If the problem persists, contact RIKEN KEIKI. |
| 082 | <ul style="list-style-type: none"> Internal thermistor abnormality The ambient conditions are too far outside the operating temperature range. | Contact RIKEN KEIKI. |
| 083 | <ul style="list-style-type: none"> Bluetooth fault Effects of abnormal noise | Gas measurement is possible in this state, but the Bluetooth function cannot be used. The Bluetooth function must be repaired if it is to be used. Contact RIKEN KEIKI. |

<Clock abnormality (FAIL CLOCK)>

| Fault No. | Cause | Action |
|-----------|---|--|
| 050 | <ul style="list-style-type: none"> Internal clock abnormality Effects of abnormal noise | Set the date and time. If this symptom occurs frequently, the internal clock must be replaced. Contact RIKEN KEIKI. |
| 051 | <ul style="list-style-type: none"> Low backup battery voltage | Lithium ion battery unit: Charge in a safe place, then set the date and time. Dry battery unit: Replace with new dry batteries (all six) in a safe place, then set the date and time. If the problem persists, the backup battery must be replaced. Contact RIKEN KEIKI. |

<Sensor abnormality (FAIL SENSOR)>

| Symptom | Cause | Action |
|---|---|---|
| Span adjustment is not possible. | <ul style="list-style-type: none"> The sensor is not correctly installed. The sensor is faulty. | Check to confirm that the sensor is correctly installed. If the sensor is faulty, it must be replaced. Contact RIKEN KEIKI. |
| | <ul style="list-style-type: none"> The calibration gas concentration setting differs from the concentration of the calibration gas supplied. | Check to confirm that the calibration gas concentration setting is the same as the concentration of the calibration gas supplied. |
| Fresh air adjustment is not possible. | <ul style="list-style-type: none"> The sensor is not correctly installed. The sensor is faulty. | Check to confirm that the sensor is correctly installed. If the sensor is faulty, it must be replaced. Contact RIKEN KEIKI. |
| | <ul style="list-style-type: none"> Clean air is not being supplied around the product. | Provide clean air. |
| Performing a bump test is not possible. | <ul style="list-style-type: none"> Calibration gas is not being supplied during a bump test. | Supply the correct calibration gas for the bump test. |
| | <ul style="list-style-type: none"> The calibration gas concentration setting differs from the concentration of the calibration gas supplied. | Check to confirm that the calibration gas concentration setting is the same as the concentration of the calibration gas supplied. |
| | <ul style="list-style-type: none"> Gas adjustment has not been performed. | Perform fresh air adjustment and span adjustment. |
| Base gas adjustment is not possible. | <ul style="list-style-type: none"> The sensor is not correctly installed. The sensor is faulty. | Check to confirm that the sensor is correctly installed. If the sensor is faulty, it must be replaced. Contact RIKEN KEIKI. |
| | <ul style="list-style-type: none"> Base gas (nitrogen (N₂) or inert gas) is not being supplied. | Supply the specified base gas. |

| Symptom | Cause | Action |
|--|---|--|
| CO ₂ zero adjustment is not possible. | <ul style="list-style-type: none"> The sensor is not correctly installed. The sensor is faulty. | <p>Check to confirm that the sensor is correctly installed. If the sensor is faulty, it must be replaced. Contact RIKEN KEIKI.</p> |
| | <ul style="list-style-type: none"> Calibration gas (nitrogen (N₂)) is not being supplied. | <p>Supply the calibration gas (nitrogen (N₂)).</p> |
| A sensor abnormality is indicated. | <ul style="list-style-type: none"> The sensor is not correctly installed. | <p>Check to confirm that the sensor is correctly installed.</p> |
| | <ul style="list-style-type: none"> The sensor is faulty. | <p>If the sensor is faulty, it must be replaced. Contact RIKEN KEIKI.</p> |
| | <ul style="list-style-type: none"> There are problems with communicating with the sensor. | <p>Replace with a new sensor.</p> |
| | <ul style="list-style-type: none"> An unsupported F sensor is installed in the product. | <p>Replace with an F sensor supported by the product.</p> |
| | <ul style="list-style-type: none"> The F sensor is installed in the wrong position (order of priority). | <p>Check the F sensor installation order.</p> |

<Other>

| Symptom | Cause | Action |
|--------------------------------|--|---|
| [PLEASE CAL] is displayed. | This indicates that more than one year has elapsed since the last adjustment date. (Japan Ex model only) | Contact RIKEN KEIKI to request maintenance. |
| [CAL DATE PAST] is displayed. | Notification that the set gas adjustment expiration date has passed (ATEX/IECEx model only) | Either perform gas adjustment yourself or contact RIKEN KEIKI to request maintenance. |
| [BUMP DATE PAST] is displayed. | Notification that the set bump expiration date has passed | Perform a bump test. |

10-2 Reading abnormalities

| Symptom | Cause | Action |
|---|--|---|
| The reading rises (or drops) and remains unchanged. | Sensor drift | Perform fresh air adjustment. |
| | Presence of interference gases | It is difficult to completely eliminate the effects of interference gases such as solvents. Contact RIKEN KEIKI for information on countermeasures, such as removal filters. |
| | Slow leakage | They may be a very small leakage (slow leakage) of the detection target gas. Leaving this unresolved may lead to hazardous conditions. Take the same action as for gas alarms. |
| | Ambient condition fluctuations such as temperature and humidity. | Perform fresh air adjustment. |
| | Sensor condensation | Perform fresh air adjustment. Particularly in the case of oxygen sensors, fresh air adjustment is required as the reading may decrease due to condensation. |
| Slow response | Dust filter clogging | Replace the dust filter. |
| | Gas sampling tube is bent or blocked. | Fix the problem. |
| | There is condensation inside the product. | Fix the problem. |
| | The sensor sensitivity has degraded. | Replace with a new sensor. Contact RIKEN KEIKI. |
| Gas adjustment is not possible. | The calibration gas concentration is inappropriate. | Prepare the correct calibration gas. |
| | The sensor sensitivity has degraded. | Replace with a new sensor. Contact RIKEN KEIKI. |

11

Product Specifications

11-1 Product specifications

11-1-1 GX-9000 specifications

| Item | Specifications |
|--------------------------------|--|
| Concentration display | LCD digital (full dot) |
| Detection target gas | Combustible gas (methane (CH ₄), isobutane (HC (i-C ₄ H ₁₀)), hydrogen (H ₂), acetylene (C ₂ H ₂)), oxygen (O ₂), toxic gas (low-concentration hydrogen sulfide (H ₂ S)), carbon monoxide (CO), ammonia (NH ₃), chlorine (Cl ₂), ozone (O ₃), hydrogen chloride (HCl), sulfur dioxide (SO ₂), hydrogen cyanide (HCN), volatile organic compounds (VOC), carbon dioxide (CO ₂) |
| Detection method | Pump suction type |
| Suction flow rate | Minimum 0.75 L/min (open flow rate) |
| Display items | Clock, battery level, operation status |
| Display languages | Japanese, English, Korean, Chinese (simplified), Chinese (traditional), Vietnamese, Italian, Spanish, Slovak, Czech, German, Turkish, French, Portuguese, Polish, Russian |
| Buzzer volume | Approx. 95 dB (mean value at 30 cm from source) |
| Gas alarm indication | Lamp flashing, continuous modulating buzzer sounding, gas concentration reading blinking |
| Gas alarm pattern | Self-latching, auto-reset |
| Fault alarm/ self-diagnosis | Flow rate abnormality, system abnormality, sensor abnormality, low battery voltage, adjustment failure, clock abnormality |
| Fault alarm indication | Lamp flashing, intermittent buzzer sounding, detail display |
| Fault alarm pattern | Self-latching |
| Communication specifications | USB 2.0 Type-C (for data logger and setup), Bluetooth 4.2 (Bluetooth Low Energy) |
| Power source | Dedicated lithium ion battery unit (BUL-9000) or dedicated dry battery unit (AA alkaline batteries × 6) (BUD-9000) ¹⁾ |
| Continuous operating time | Lithium ion battery unit: approx. 25 hours Dry battery unit: approx. 12 hours At 25 °C, no alarm, no lighting The continuous operating time varies depending on the sensor installed. |
| Operating temperature range | Approx. 15-minute temporary use environment: -40 °C to +60 °C (no sudden changes) Continuous use environment: -20 °C to +50 °C (no sudden changes) May vary depending on the sensors installed. (Refer to '11-2 Sensor specifications'.) |
| Operating humidity range | Approx. 15-minute temporary use environment: 0 to +95 %RH (no condensation) Continuous use environment: 10 to +90 %RH (no condensation) May vary depending on the sensors installed. (Refer to '11-2 Sensor specifications'.) |
| Operating pressure range | 80 kPa to 120 kPa (80 kPa to 110 kPa for explosion-proof range) |
| Construction | Dustproof, waterproof construction equivalent to IP66/68 ²⁾ , drop resistant to 1.5 m |

| Item | Specifications |
|------------------------------|---|
| Explosion-proof construction | Japan Ex (explosion-proof electrical equipment type certified) models: Intrinsically safe explosion-proof construction, flame-proof enclosure (with new ceramic type sensor installed) Intrinsically safe explosion-proof construction (without new ceramic type sensor installed) ATEX/IECEx models: Intrinsically safe explosion-proof construction, flame-proof enclosure (with new ceramic type sensor installed) Intrinsically safe explosion-proof construction (without new ceramic type sensor installed) |
| Explosion-proof class | Japan Ex (explosion-proof electrical equipment type certified) models: Ex da ia IIC T4 Ga (with new ceramic type sensor installed) Ex ia IIC T4 Ga (without new ceramic type sensor installed) ATEX models ^{*3} : II 1 G Ex da ia IIC T4 Ga (with new ceramic type sensor installed) II 1 G Ex ia IIC T4 Ga (without new ceramic type sensor installed) IECEx models ^{*3} : Ex da ia IIC T4 Ga (with new ceramic type sensor installed) Ex ia IIC T4 Ga (without new ceramic type sensor installed) |
| Certifications | JIS T 8201:2010 (Oxygen deficiency indicator) JIS T 8205:2018 (Hydrogen sulfide indicator/alarm) |
| External dimensions | Approximately 158 (W) × 85 (H) × 132 (D) mm |
| Weight | Approx. 1.1 kg |

*1: Japan Ex models can use six LR6 batteries manufactured by Toshiba.

ATEX/IECEx models can use either six LR6 batteries manufactured by Toshiba or six MN1500 batteries manufactured by Duracell.

*2: IPx8 rating indicates no water ingress when submerged for one hour at water depth of 2 m.

*3: Dry battery models when using Duracell (MN1500) batteries: -40 °C to +40 °C: T4, -40 °C to +60 °C: T3

11-1-2 GX-9000H specifications

| Item | Specifications |
|--------------------------------|--|
| Concentration display | LCD digital (full dot) |
| Detection target gas | Combustible gas (methane (CH ₄), isobutane (HC (i-C ₄ H ₁₀))), oxygen (O ₂), hydrogen sulfide (H ₂ S) low-concentration/high-concentration, carbon monoxide (CO) |
| Detection method | Pump suction type |
| Suction flow rate | Minimum 0.75 L/min (open flow rate) |
| Display items | Clock, battery level, operation status |
| Display languages | Japanese, English, Korean, Chinese (simplified), Chinese (traditional), Vietnamese, Italian, Spanish, Slovak, Czech, German, Turkish, French, Portuguese, Polish, Russian |
| Buzzer volume | Approx. 95 dB (mean value at 30 cm from source) |
| Gas alarm indication | Lamp flashing, continuous modulating buzzer sounding, gas concentration reading blinking |
| Gas alarm pattern | Self-latching, auto-reset |
| Fault alarm/ self-diagnosis | Flow rate abnormality, system abnormality, sensor abnormality, low battery voltage, adjustment failure, clock abnormality |
| Fault alarm indication | Lamp flashing, intermittent buzzer sounding, detail display |
| Fault alarm pattern | Self-latching |
| Communication specifications | USB 2.0 Type-C (for data logger and setup), Bluetooth 4.2 (Bluetooth Low Energy) |
| Power source | Dedicated lithium ion battery unit (BUL-9000) or dedicated dry battery unit (AA alkaline batteries × 6) (BUD-9000)*1 |
| Continuous operating time | Lithium ion battery unit: approx. 35 hours Dry battery unit: approx. 15 hours At 25 °C, no alarm, no lighting |
| Operating temperature range | Approx. 15-minute temporary use environment: -40 °C to +60 °C (no sudden changes) Continuous use environment: -20 °C to +50 °C (no sudden changes) |
| Operating humidity range | Approx. 15-minute temporary use environment: 0 to +95 %RH (no condensation) Continuous use environment: 10 to +90 %RH (no condensation) |
| Operating pressure range | 80 kPa to 120 kPa (80 kPa to 110 kPa for explosion-proof range) |
| Construction | Dustproof, waterproof construction equivalent to IP66/68 (excluding pipes)*2, drop resistant to 1.5 m |
| Explosion-proof construction | Japan Ex (explosion-proof electrical equipment type certified) models: Intrinsically safe explosion-proof construction ATEX/IECEx models: Intrinsically safe explosion-proof construction |
| Explosion-proof class | Japan Ex (explosion-proof electrical equipment type certified) models: Ex ia IIC T4 Ga ATEX models*3: II 1 G Ex ia IIC T4 Ga IECEx models*3: Ex ia IIC T4 Ga |
| Certifications | JIS T 8201:2010 (Oxygen deficiency indicator) JIS T 8205:2018 (Hydrogen sulfide indicator/alarm) |
| External dimensions | Approximately 158 (W) × 85 (H) × 132 (D) mm |
| Weight | Approx. 1.2 kg |

*1: Japan Ex models can use six LR6 batteries manufactured by Toshiba.

ATEX/IECEx models can use either six LR6 batteries manufactured by Toshiba or six MN1500 batteries manufactured by Duracell.

*2: IPx8 rating indicates no water ingress when submerged for one hour at water depth of 2 m.

*3: Dry battery models when using Duracell (MN1500) batteries: -40 °C to +40 °C: T4, -40 °C to +60 °C: T3

11-2 Sensor specifications

11-2-1 Combustible gas sensors

<New ceramic type>

| Item | Detection target gas | Methane CH ₄ | Methane CH ₄ |
|--|--|----------------------------|----------------------------|
| Sensor model | | NCF-6322P | NCF-6322P M |
| Explosion-proof specifications | | Japan Ex | ATEX/IECEX |
| Display range | | 0 – 100 %LEL | 0 – 100 %LEL |
| Detection range | | 0 – 100 %LEL | 0 – 100 %LEL |
| Resolution | | 1 %LEL | 1 %LEL |
| Alarm setpoints | First alarm | 10 %LEL | 10 %LEL |
| | Second alarm | 50 %LEL | 50 %LEL |
| | TWA | - | - |
| | STEL | - | - |
| | OVER | 100 %LEL | 100 %LEL |
| Operating temperature range*1 | Continuous use environment | -20 °C to +50 °C | -20 °C to +50 °C |
| | Temporary use environment (approx. 15 minutes) | -40 °C to +60 °C | -40 °C to +60 °C |
| Operating humidity range*2 | Continuous use environment | 10 to 90 %RH | 10 to 90 %RH |
| | Temporary use environment (approx. 15 minutes) | 95 %RH or less | 95 %RH or less |
| Indication accuracy (for identical conditions) | | Within ±5 %LEL | Within ±5 %LEL |
| Response time (T90) | | Within 30 seconds | Within 30 seconds |

| Item | Detection target gas | Isobutane HC (i-C ₄ H ₁₀) | Hydrogen H ₂ | Acetylene C ₂ H ₂ |
|--|--|---|----------------------------|--|
| Sensor model | | NCF-6322P | | |
| Explosion-proof specifications | | Japan Ex and ATEX/IECEX | | |
| Display range | | 0 – 100 %LEL | 0 – 100 %LEL | 0 – 100 %LEL |
| Detection range | | 0 – 100 %LEL | 0 – 100 %LEL | 0 – 100 %LEL |
| Resolution | | 1 %LEL | 1 %LEL | 1 %LEL |
| Alarm setpoints | First alarm | 10 %LEL | 10 %LEL | 10 %LEL |
| | Second alarm | 50 %LEL | 50 %LEL | 50 %LEL |
| | TWA | - | - | - |
| | STEL | - | - | - |
| | OVER | 100 %LEL | 100 %LEL | 100 %LEL |
| Operating temperature range*1 | Continuous use environment | -20 °C to +50 °C | -20 °C to +50 °C | -20 °C to +50 °C |
| | Temporary use environment (approx. 15 minutes) | -40 °C to +60 °C | -40 °C to +60 °C | -40 °C to +60 °C |
| Operating humidity range*2 | Continuous use environment | 10 to 90 %RH | 10 to 90 %RH | 10 to 90 %RH |
| | Temporary use environment (approx. 15 minutes) | 95 %RH or less | 95 %RH or less | 95 %RH or less |
| Indication accuracy (for identical conditions) | | Within ±5 %LEL | Within ±5 %LEL | Within ±5 %LEL |
| Response time (T90) | | Within 30 seconds | Within 30 seconds | Within 30 seconds |

*1: no sudden changes

*2: no condensation



CAUTION

- Do not install sensors for different gas types when using a combustible gas sensor. A new ceramic type sensor and a thermal conductivity type sensor can be used in combination to detect the same gas type.
 - Quality cannot be guaranteed if sensors for different gas types are used.
- The detection target gas is specified at the time of purchase.
- Sensor characteristics may degrade significantly in the presence of silicone gases (organic silicon-based gases), halogen gases, sulfide gases, or acidic gases.
- Allow the product to warm up for at least 10 minutes in air before performing fresh air adjustment or span adjustment.
- If the sensors have been in contact with nitrogen (N₂) or high-concentration gas, exhaust for at least five minutes before performing gas adjustment.
 - If no oxygen sensor is installed and the product comes into contact with high-concentration gas of 100 %LEL or more, an OVER alarm will occur and remain until it is reset. (Refer to '4-3 Gas alarm patterns'.)
 - Readings will be given even for combustible gases other than the detection target gas.
- In user mode, contact with high-concentration gas of 100 %LEL or more will damage the sensor.
- If the oxygen concentration drops below 10 %, the combustible gas concentration reading for NCF sensors will appear as [----], and if the NCF/TEF sensor range setting is set to [AUTO RANGE] (default setting), the display changes to the TEF sensor reading. If [LEL ONLY] is set, measurement will not be performed. Reassess the usage environment. (Refer to '6-4-1 Setting the NCF/TEF sensor range'.)
- If the oxygen sensor (ESR-X13P) is not installed or if the combustible gas concentration is displayed only in the %LEL range, the OVER alarm will remain fixed if the measured combustible gas concentration exceeds 100 %LEL.
 - To reset the alarm, press the RESET/▼ button in the presence of clean air. The concentration display resumes a short while after pressing the RESET/▼ button.
- When oxygen concentrations fall, the readings may also fall.
- It cannot be used at oxygen concentrations of 10 % or lower. The gas concentration display will appear as [----].
- With high oxygen concentrations, contact with high-concentration gas of 100 %LEL or more may damage the sensor. Perform fresh air adjustment and span adjustment if the zero point has fluctuated.
- For measurements performed in locations where high-concentration combustible gases are known to be present, select [VOL ONLY] for the NCF/TEF sensor range setting. (Refer to '6-4-1 Setting the NCF/TEF sensor range'.)
- Some interference may occur in environments where highly thermally conductive gases such as carbon dioxide (CO₂), argon (Ar), and helium (He) are present in high concentrations as base gases.
- When low vapor pressure gases are measured by aspiration, the gas may condense when aspirated from a warmer area and measured in a cooler area, or blockage may occur in sintered alloy. Keep vapor pressure in mind when using the product.
- Indication accuracy may degrade in situations in which temperatures fluctuate significantly (±40 °C or greater) above or below the ambient temperature in which fresh air adjustment and span adjustment was performed. If this occurs, readjust.
- Readings may fluctuate if the product is subject to strong external impact or vibration. If this occurs, perform fresh air adjustment and span adjustment.
- The sensor may be hot during replacement. Be careful to avoid burns when replacing the sensor. If the sensor is hot, turn off the power and wait for it to cool.

- There is a Teflon film on the top of the sensors. There may be an impact on flow characteristics due to main unit pump suction if this Teflon film is damaged. Avoid applying excessive pressure or sharp objects to the Teflon film.
 - If the conditions change suddenly from room temperature to hot and humid conditions, the reading may be lower than it should be due to condensation.
-

NOTE

- ▶ The alarm setpoints indicated in the table above can be altered. However, the setpoint cannot be changed for those shown as "-". (Refer to '7-3-1 Setting alarm setpoints'.)
-

<Thermal conductivity type>

| Item | Detection target gas | Methane CH ₄ | Isobutane HC (i-C ₄ H ₁₀)*1 | Hydrogen H ₂ |
|--|--|-------------------------|--|-------------------------|
| Sensor model | | TEF-7520P | | |
| Explosion-proof specifications | | Japan Ex and ATEX/IECEX | | |
| Display range | | 0 – 100.0 vol% | 0 – 100.0 vol% | 0 – 100.0 vol% |
| Detection range | | 0 – 100.0 vol% | 0 – 100.0 vol% | 0 – 100.0 vol% |
| Resolution | | 0.1 vol% | 0.1 vol% | 0.1 vol% |
| Alarm setpoints | First alarm | 25.0 vol% | 25.0 vol% | 25.0 vol% |
| | Second alarm | 50.0 vol% | 50.0 vol% | 50.0 vol% |
| | TWA | - | - | - |
| | STEL | - | - | - |
| | OVER | 100.0 vol% | 100.0 vol% | 100.0 vol% |
| Operating temperature range*2 | Continuous use environment | -20 °C to +50 °C | -20 °C to +50 °C | -20 °C to +50 °C |
| | Temporary use environment (approx. 15 minutes) | -40 °C to +60 °C | -40 °C to +60 °C | -40 °C to +60 °C |
| Operating humidity range*3 | Continuous use environment | 10 to 90 %RH | 10 to 90 %RH | 10 to 90 %RH |
| | Temporary use environment (approx. 15 minutes) | 95 %RH or less | 95 %RH or less | 95 %RH or less |
| Indication accuracy (for identical conditions) | | Within ±5 vol% | Within ±5 vol% | Within ±5 vol% |
| Response time (T90) | | Within 30 seconds | Within 30 seconds | Within 30 seconds |

*1: At temperatures below approximately -10 °C, isobutane (HC (i-C₄H₁₀)) may liquefy.

*2: no sudden changes

*3: no condensation

**CAUTION**

- The detection target gas is specified at the time of purchase.
- Sensors may be damaged in the presence of high-concentration organic gases or alcohol. Repeat adjustment if the zero point has fluctuated.
- These sensors may also react to gases other than the detection target gas if the thermal conductivity differs significantly from fresh air.

NOTE

- ▶ The alarm setpoints indicated in the table above can be altered. However, the setpoint cannot be changed for those shown as "-". (Refer to '7-3-1 Setting alarm setpoints'.)

<Non-dispersive infrared type (NDIR)>

| Item | Detection target gas | Methane CH ₄ | Isobutane HC (i-C ₄ H ₁₀)* ¹ |
|--|--|--|--|
| Sensor model | | IRF-4341 | IRF-4345 |
| Explosion-proof specifications | | Japan Ex and ATEX/IECEX | |
| Display range | | 0 – 100.0 %LEL/ 100.0 %LEL – 100.0 vol% | 0 – 100.0 %LEL/ 100.0 %LEL – 100.0 vol% |
| Detection range | | 0 – 100.0 %LEL/ 100.0 %LEL – 100.0 vol% | 0 – 100.0 %LEL/ 100.0 %LEL – 100.0 vol% |
| Resolution | | 0.5 %LEL/0.1 vol% | 0.5 %LEL/0.1 vol% |
| Alarm setpoints | First alarm | 10.0 %LEL | 10.0 %LEL |
| | Second alarm | 50.0 %LEL | 50.0 %LEL |
| | TWA | - | - |
| | STEL | - | - |
| | OVER | 100.0 vol% | 100.0 vol% |
| Operating temperature Range* ² | Continuous use environment | -20 °C to +50 °C | -20 °C to +50 °C |
| | Temporary use environment (approx. 15 minutes) | -40 °C to +60 °C | -40 °C to +60 °C |
| Operating humidity Range* ³ | Continuous use environment | 10 to 90 %RH | 10 to 90 %RH |
| | Temporary use environment (approx. 15 minutes) | 95 %RH or less | 95 %RH or less |
| Indication accuracy (for identical conditions) | | Within ±5 %LEL | Within ±5 %LEL |
| Response time (T90) | | Within 30 seconds | Within 30 seconds |

*1: At temperatures below approximately -10 °C, isobutane (HC (i-C₄H₁₀)) may liquefy.

*2: no sudden changes

*3: no condensation

**CAUTION**

- Allow the product to warm up for at least 10 minutes before performing fresh air adjustment or span adjustment.
- Ensure identical temperatures, humidity, and pressure in the gas adjustment and measurement environments. The reading may fluctuate due to the temperature, humidity, and pressure characteristics.
- Interference occurs due to hydrocarbons other than the target gas.
- If the composition of the base gas differs greatly for gas adjustment and measurement—for example, if an air base is used for gas adjustment but a carbon dioxide base is used for measurement—readings may differ due to infrared adsorption characteristics, even if the concentration of the target gas is the same.

NOTE

- ▶ The alarm setpoints indicated in the table above can be altered. However, the setpoint cannot be changed for those shown as "-". (Refer to '7-3-1 Setting alarm setpoints'.)

11-2-2 Carbon dioxide sensor

<Non-dispersive infrared type (NDIR)>

| Item | Detection target gas | Carbon dioxide CO ₂ | |
|--|--|---|-------------------|
| | | IRF-4443 | IRF-4433 |
| Sensor model | | IRF-4443 | IRF-4433 |
| Explosion-proof specifications | | Japan Ex and ATEX/IECEX | |
| Display range | | 0 – 20.00 vol% | 0 – 10,000 ppm |
| Detection range | | 0 – 20.00 vol% | 0 – 10,000 ppm |
| Resolution | | 0.01 vol% (0 – 5 vol%) 0.10 vol% (5 – 20 vol%) | 20 ppm |
| Alarm setpoints | First alarm | 5.00 vol% | 5,000 ppm |
| | Second alarm | 10.00 vol% | 5,000 ppm |
| | TWA | - | 5,000 ppm |
| | STEL | - | - |
| | OVER | 20.00 vol% | 10,000 ppm |
| Operating temperature range*1 | Continuous use environment | -20 °C to +50 °C | -20 °C to +50 °C |
| | Temporary use environment (approx. 15 minutes) | -40 °C to +60 °C | -40 °C to +60 °C |
| Operating humidity range*2 | Continuous use environment | 10 to 90 %RH | 10 to 90 %RH |
| | Temporary use environment (approx. 15 minutes) | 95 %RH or less | 95 %RH or less |
| Indication accuracy (for identical conditions) | | Within ±1 vol% | Within ±500 ppm |
| Response time (T90) | | Within 30 seconds | Within 30 seconds |

*1: no sudden changes

*2: no condensation

**CAUTION**

- Allow the product to warm up for at least 10 minutes before performing CO₂ zero adjustment or span adjustment.
- Ensure identical temperatures, humidity, and pressure in the gas adjustment and measurement environments. The reading may fluctuate due to the temperature, humidity, and pressure characteristics.
- If the composition of the base gas differs greatly for gas adjustment and measurement—for example, if an air base is used for gas adjustment but an argon base is used for measurement—readings may differ due to infrared adsorption characteristics, even if the concentration of the target gas is the same.

NOTE

- ▶ The sensors used in the product may exhibit sensitivity variations when used continuously for extended periods.
The zero follower function stabilizes the zero point by correcting reading fluctuations at the zero point (400 ppm for carbon dioxide sensors) that result from extended periods of use.
- ▶ The zero follower function can be altered using the setup program sold separately. (The default setting is enabled.)

- The alarm setpoints indicated in the table above can be altered. However, the setpoint cannot be changed for those shown as "-". (Refer to '7-3-1 Setting alarm setpoints'.)

11-2-3 Oxygen sensor

<Electrochemical type>

| Item | Detection target gas | Oxygen O ₂ | |
|--|--|--------------------------|-------------------|
| Sensor model | | ESR-X13P | |
| Explosion-proof specifications | | Japan Ex | ATEX/IECEX |
| Display range | | 0 – 40.0 % | 0 – 40.0 % |
| Detection range | | 0 – 25.0 % | 0 – 25.0 % |
| Resolution | | 0.1 % | 0.1 % |
| Alarm setpoints | First alarm | 18.0 % | 19.5 % |
| | Second alarm | 25.0 % | 23.5 % |
| | TWA | - | - |
| | STEL | - | - |
| | OVER | 40.0 % | 40.0 % |
| Operating temperature range*1 | Continuous use environment | -20 °C to +50 °C | -20 °C to +50 °C |
| | Temporary use environment (approx. 15 minutes) | -40 °C to +60 °C | -40 °C to +60 °C |
| Operating humidity range*2 | Continuous use environment | 10 to 90 %RH | 10 to 90 %RH |
| | Temporary use environment (approx. 15 minutes) | 95 %RH or less | 95 %RH or less |
| Indication accuracy (for identical conditions) | | Within ±0.7 vol% | Within ±0.7 vol% |
| Response time (T90) | | Within 20 seconds | Within 20 seconds |

*1: no sudden changes

*2: no condensation



CAUTION

- Do not, under any circumstances, disassemble the sensor. The constant-potential electrolysis sensor contains an electrolyte that is hazardous.
- For each type of sensor has a specified installation position on the main unit. Sensors will not function correctly if installed in the wrong location or not properly oriented. Applying excessive force to install sensors may damage the sensor and main unit. It may also result in sensor failure.
- The label indicating the gas name also constitutes an important part. Avoid damaging or fouling the label. Using while damaged may prevent the product from sampling gas correctly.
- Do not press or peel off the silver label affixed to the sensor. Doing so may result in measurement performance that falls short of the above specifications.
- Do not use any gas other than nitrogen (N₂) as the balance gas for gas adjustment. Otherwise, reading errors will increase, preventing accurate measurement.
- Do not expose to sudden pressure fluctuations. The reading will fluctuate briefly, preventing accurate measurement.
- Do not subject the sampling tube or other pipes to positive or negative pressure. Applying pressure may cause the reading to fluctuate and trigger an alarm. If the reading changes, remove any pressure applied before resuming use.

NOTE

- ▶ The sensor output is affected by environmental factors such as temperature and humidity, as well as by interfering gases.
As a result, fluctuations may be observed near the zero reading (20.9% in the case of oxygen) due to these factors.
The zero suppression function serves to minimize the visibility of such fluctuations. This function masks indication fluctuations around a preset range near zero (20.4% to 21.4% for oxygen), so that the sensor indicates zero (20.9% for oxygen).
 - ▶ The zero suppression function can be changed using an optional configuration program. (Default setting: ON)
 - ▶ For oxygen sensors, the zero tracking function will not operate even if it is enabled using the optional configuration program.
 - ▶ The alarm setpoints listed in the table above can be changed. However, alarm points marked with “-” cannot be modified. (See “7-3-1 Setting Alarm Points”)
-

11-2-4 Toxic gas sensors

<Electrochemical type (ESR sensors)>

| Item | Detection target gas | Hydrogen sulfide H ₂ S (low concentration) | | Carbon monoxide CO | |
|--|--|--|--|---|---|
| Sensor model | | ESR-A13i | | ESR-A13P | |
| Explosion-proof specifications | | Japan Ex | ATEX/IECEx | Japan Ex | ATEX/IECEx |
| Display range | | 0 – 200.0 ppm | 0 – 200.0 ppm | 0 – 2,000 ppm | 0 – 2,000 ppm |
| Detection range | | 0 – 30.0 ppm | 0 – 100.0 ppm | 0 – 500 ppm | 0 – 500 ppm |
| Resolution | | 0.1 ppm | 0.1 ppm | 1 ppm | 1 ppm |
| Alarm setpoints | First alarm | 1.0 ppm | 5.0 ppm | 25 ppm | 25 ppm |
| | Second alarm | 10.0 ppm | 30.0 ppm | 50 ppm | 50 ppm |
| | TWA | 1.0 ppm | 1.0 ppm | 25 ppm | 25 ppm |
| | STEL | 5.0 ppm | 5.0 ppm | 200 ppm | 200 ppm |
| | OVER | 200.0 ppm | 200.0 ppm | 2,000 ppm | 2,000 ppm |
| Operating temperature range*1 | Continuous use environment | -20 °C to +50 °C | -20 °C to +50 °C | -20 °C to +50 °C | -20 °C to +50 °C |
| | Temporary use environment (approx. 15 minutes) | -40 °C to +60 °C | -40 °C to +60 °C | -40 °C to +60 °C | -40 °C to +60 °C |
| Operating humidity range*2 | Continuous use environment | 10 to 90 %RH | 10 to 90 %RH | 10 to 90 %RH | 10 to 90 %RH |
| | Temporary use environment (approx. 15 minutes) | 95 %RH or less | 95 %RH or less | 95 %RH or less | 95 %RH or less |
| Indication accuracy (for identical conditions) | | Within ± 1.5 ppm (0 – 30 ppm) | Within ± 1.5 ppm (0 – 30 ppm) Within ± 20 % of reading (30 – 100.0 ppm) | Within ± 15 ppm (0 – 30 ppm) Within ± 20 % of reading (30 – 500 ppm) | Within ± 15 ppm (0 – 30 ppm) Within ± 20 % of reading (30 – 500 ppm) |
| Response time (T90) | | Within 30 seconds | Within 30 seconds | Within 30 seconds | Within 30 seconds |

*1: no sudden changes

*2: no condensation

**CAUTION**

- Do not, under any circumstances, disassemble the sensor. The constant-potential electrolysis sensor contains an electrolyte that is hazardous.
- Each sensor has a specified installation position on the main unit. Sensors will not function correctly if installed in the wrong location or not properly oriented. Applying excessive force to install sensors may damage the sensor and main unit. It may also result in sensor failure.
- The label indicating the gas name also constitutes an important part. Avoid damaging or fouling the label. Using while damaged may prevent the product from sampling gas correctly.

<ESR-A13i>

- When using the sensor, it is recommended to attach the humidity control filter CF-A13i. The CF-A13i filter helps to moderate sudden changes in humidity and reduces the likelihood of false alarms. Condensation or the presence of significant moisture in the humidity control filter CF-A13i will significantly impair gas sensitivity. If there is reason to believe condensation may have occurred inside the pipes—for example, in cases in which the air drawn in is warmer or more humid than the operating temperature and humidity range—draw in fresh air and check to confirm that gas sensitivity is normal before resuming use.

<ESR-A13P>

- When using the sensor, it is recommended to use the activated carbon filter CF-A1CP. This filter removes interfering gases and helps reduce the likelihood of false alarms.
 - The activated carbon filter has a limited service life. Even under consistent usage conditions, if the readings begin to fluctuate significantly, it may indicate that the filter has reached the end of its life. In such cases, please replace the filter.
-

NOTE

- ▶ The sensor output is affected by environmental conditions such as temperature and humidity, as well as by interfering gases.
As a result, fluctuations may appear in the readings near zero.
The zero suppression function minimizes the visibility of such fluctuations. It masks variations within a predefined range near zero and forces the display to indicate zero.
For example: ± 0.3 ppm for hydrogen sulfide sensors, ± 2 ppm for carbon monoxide sensors.
 - ▶ The sensors used in the product may exhibit sensitivity variations when used continuously for extended periods.
The zero follower function stabilizes the zero point by correcting reading fluctuations at the zero point that result from extended periods of use.
 - ▶ The suppression function can be altered using the setup program sold separately. (The default setting is enabled.)
 - ▶ The zero follower function can be altered using the setup program sold separately. (The default setting is enabled.)
 - ▶ The alarm setpoints indicated in the table above can be altered. (Refer to '7-3-1 Setting alarm setpoints'.)
-

<Electrochemical type (ESF sensors)>

| Item | Detection target gas | Hydrogen sulfide H ₂ S (high concentration) | Ammonia NH ₃ | Chlorine Cl ₂ | Ozone O ₃ |
|--|--|---|----------------------------|-----------------------------|-------------------------|
| Sensor model | | ESF-A24R2 | ESF-B242 | ESF-C930 | ESF-B249 |
| Explosion-proof specifications | Japan Ex and ATEX/IECEx | | | | |
| Display range | | 0 – 1,000 ppm | 0 – 75.0 ppm | 0 – 1.50 ppm | 0 – 0.600 ppm |
| Detection range | | 0 – 1,000 ppm | 0 – 75.0 ppm | 0 – 1.50 ppm | 0 – 0.600 ppm |
| Resolution | | 1 ppm | 0.5 ppm | 0.01 ppm | 0.005 ppm |
| Alarm setpoints | First alarm | 1,000 ppm | 25.0 ppm | 0.50 ppm | 0.100 ppm |
| | Second alarm | 1,000 ppm | 50.0 ppm | 1.00 ppm | 0.200 ppm |
| | TWA | OFF | 25.0 ppm | 0.50 ppm | 0.100 ppm |
| | STEL | OFF | 35.0 ppm | 1.00 ppm | OFF |
| | OVER | 1,000 ppm | 75.0 ppm | 1.50 ppm | 0.600 ppm |
| Operating temperature range | Continuous use environment | -20 °C to +50 °C | -20 °C to +50 °C | 0 °C to +50 °C | 10 °C to +40 °C |
| | Temporary use environment (approx. 15 minutes) | -40 °C to +60 °C | -40 °C to +60 °C | -40 °C to +60 °C | 10 °C to +40 °C |
| Operating humidity range | Continuous use environment | 20 to 90 %RH | 30 to 80 %RH | 30 to 80 %RH | 30 to 80 %RH |
| | Temporary use environment (approx. 15 minutes) | 95 %RH or less | 95 %RH or less | 95 %RH or less | 95 %RH or less |
| Indication accuracy (for identical conditions) | | Reading ±20 % | Within ±7.5 ppm | Within ±0.15 ppm | Within ±0.06 ppm |
| Response time (T90) | | 9 seconds (typical) | 19 seconds (typical) | 53 seconds (typical) | 10 seconds (typical) |

| Item | Detection target gas | Hydrogen chloride HCl | Sulfur dioxide SO ₂ | Hydrogen cyanide HCN ^{*3} | Hydrogen cyanide HCN ^{*3} |
|--|--|--------------------------|--|---------------------------------------|---------------------------------------|
| Sensor model | | ESF-A24E2 | ESF-A24D4 | ESF-A24D | ESF-A24DX |
| Explosion-proof specifications | Japan Ex and ATEX/IECEx | | | Japan Ex | ATEX/IECEx |
| Display range | | 0 – 6.00 ppm | 0 – 100.0 ppm | 0 – 15.0 ppm | 0 – 15.0 ppm |
| Detection range | | 0 – 6.00 ppm | 0 – 100.0 ppm | 0 – 15.0 ppm | 0 – 15.0 ppm |
| Resolution | | 0.05 ppm | 0.1 ppm | 0.1 ppm | 0.1 ppm |
| Alarm setpoints | First alarm | 2.00 ppm | 2.0 ppm | 5.0 ppm | 5.0 ppm |
| | Second alarm | 4.00 ppm | 5.0 ppm | 10.0 ppm | 10.0 ppm |
| | TWA | OFF | 2.0 ppm | OFF | OFF |
| | STEL | OFF | 5.0 ppm | 4.7 ppm | 4.7 ppm |
| | OVER | 6.00 ppm | 100.0 ppm | 15.0 ppm | 15.0 ppm |
| Operating temperature range ^{*1} | Continuous use environment | 0 °C to +40 °C | -20 °C to +50 °C | -20 °C to +50 °C | -20 °C to +50 °C |
| | Temporary use environment (approx. 15 minutes) | 0 °C to +40 °C | -40 °C to +60 °C | -40 °C to +60 °C | -40 °C to +60 °C |
| Operating humidity range ^{*2} | Continuous use environment | 20 to 90 %RH | 20 to 90 %RH | 20 to 90 %RH | 20 to 90 %RH |
| | Temporary use environment (approx. 15 minutes) | 95 %RH or less | 95 %RH or less | 95 %RH or less | 95 %RH or less |
| Indication accuracy (for identical conditions) | | Within ±0.6 ppm | Within ±0.3 ppm (0 – 6 ppm) Within ±10 % of reading (6 – 100 ppm) | Within ±1.5 ppm | Within ±1.5 ppm |
| Response time (T90) | | 46 seconds (typical) | 21 seconds (typical) | 33 seconds (typical) | 33 seconds (typical) |

*1: no sudden changes

*2: no condensation

*3: Due to export restrictions, this cannot be installed in products exported outside Japan.

*4: Due to export restrictions, concentrations of 0.0 – 0.3 ppm are indicated as 0.0 ppm.



CAUTION

- Do not, under any circumstances, disassemble the sensor. The constant-potential electrolysis sensor contains an electrolyte that is hazardous.
- Sensors will not operate if installed in the wrong direction. Forcibly installing sensors may damage the sensor and main unit. It may also result in sensor failure.
- When measuring in locations where hydrogen sulfide (H₂S) may be present at high concentrations, measure using H₂S high concentration measurement mode.
- When measuring hydrogen sulfide concentrations, first check to confirm that the hydrogen sulfide concentration is below 100 ppm in H₂S high concentration measurement mode before measuring combustible gas and oxygen concentrations in H₂S low concentration measurement mode. Sucking in high concentrations of hydrogen sulfide (H₂S) while in H₂S low concentration measurement mode may damage the combustible gas (new ceramic type), carbon monoxide, and low concentration hydrogen sulfide sensors.
- Using the sensor in high or low humidity environments may result in reduced accuracy of readings.
- Adjustments made in high or low temperatures, or significant temperature changes, may lead to a decrease in the accuracy of readings.
- Sudden changes in temperature, humidity, or pressure may cause fluctuations in the readings.

<ESF-C930/ESF-B249>

- Sensitivity will be reduced temporarily if the sensor comes into contact with hydrogen sulfide (H₂S).

NOTE

- ▶ The alarm setpoints indicated for setpoints in the table above can be changed (or disabled). (Refer to '7-3-1 Setting alarm setpoints'.)
-

11-2-5 VOC sensors

<Photo-ionization type (PID)>

| Item | Detection target gas | Volatile organic compounds VOCs | Volatile organic compounds VOCs | Volatile organic compounds VOCs |
|--|--|--|--|---|
| Sensor model | | PIF-001 | PIF-002 | PIF-003 |
| Photo-ionization energy | | 10.6 eV | 10.6 eV | 10.0 eV |
| Explosion-proof specifications | | Japan Ex and ATEX/IECEx | Japan Ex and ATEX/IECEx | Japan Ex and ATEX/IECEx |
| Display range | | 0 – 40,000 ppb | 0 – 4,000 ppm | 0 – 100.0 ppm |
| Detection range | | 0 – 40,000 ppb | 0 – 4,000 ppm | 0 – 100.0 ppm |
| Resolution | | 1 ppb (0 – 4,000 ppb) 10 ppb (4,000 – 40,000 ppb) | 0.1 ppm (0 – 400.0 ppm) 1 ppm (400.0 – 4,000 ppm) | 0.01 ppm (0 – 10.00 ppm) 0.1 ppm (10.00 – 100.0 ppm) |
| Alarm setpoints | First alarm | 5,000 ppb | 400.0 ppm | 5.00 ppm |
| | Second alarm | 10,000 ppb | 1,000 ppm | 10.0 ppm |
| | TWA | OFF | OFF | OFF |
| | STEL | OFF | OFF | OFF |
| | OVER | 40,000 ppb | 4,000 ppm | 100.0 ppm |
| Operating temperature range*1 | Continuous use environment | -20 °C to +50 °C | -20 °C to +50 °C | -20 °C to +50 °C |
| | Temporary use environment (approx. 15 minutes) | -40 °C to +60 °C | -40 °C to +60 °C | -40 °C to +60 °C |
| Operating humidity range*2 | Continuous use environment | 10 to 90 %RH | 10 to 90 %RH | 10 to 90 %RH |
| | Temporary use environment (approx. 15 minutes) | 95 %RH or less | 95 %RH or less | 95 %RH or less |
| Indication accuracy (for identical conditions) | | Within ±2,500 ppb | Within ±180 ppm | Within ±5 ppm |
| Response time (T90) | | Within 30 seconds | Within 30 seconds | Within 30 seconds |

*1: no sudden changes

*2: no condensation

**CAUTION**

- If the VOC sensor is exposed to high concentrations of methane (CH₄), ethane (C₂H₆), propane (C₃H₈), or other gases, [----] may appear on the concentration display, the lamps may flash, and the buzzer may sound, temporarily disabling measurement.

In environments where these gases are present, even if the concentration display does not indicate [----], be aware that the VOC concentration may not be accurately measured.

Note that, even if the VOC sensor concentration display indicates [----], other unaffected sensors can continue measurement.

<Example interference gases causing [----] to be displayed on the VOC sensor concentration display>

| Interference gas | Concentration |
|--|-----------------|
| Methane (CH ₄) | 6 vol% or more |
| Ethane (C ₂ H ₆) | 80 vol% or more |
| Propane (C ₃ H ₈) | 90 vol% or more |

NOTE

- ▶ The alarm setpoints indicated for setpoints in the table above can be changed (or disabled). (Refer to '7-3-1 Setting alarm setpoints'.)

12

Appendix

12-1 Data logger function

The product is equipped with a data logger function that records measurement results and events such as gas alarms, fault alarms, and gas adjustment.

NOTE

- ▶ The data logger management program sold separately is required to check data recorded using the data logger function. Contact RIKEN KEIKI for more information.

The data logger provides the following five functions:

(1) Interval trend

Records the changes in measured concentration from the start of measurement until the power is turned off. If the alarm type is H-HH or L-LL, the average value, maximum value, and maximum value detection time are recorded; if the alarm type is L-H, the average value, minimum value, and minimum value detection time are recorded,

The 3,600 most recent data items are recorded.

If the number of items exceeds 3,600, the oldest data will be overwritten by the latest data.

However, if the maximum recording time is exceeded, the oldest data will be deleted before reaching 3,600.

The maximum recording times corresponding to different intervals are as follows:

| Interval | 10 seconds | 20 seconds | 30 seconds | 1 minute | 3 minutes | 5 minutes | 10 minutes |
|------------------------|------------|------------|------------|----------|-----------|-----------|------------|
| Maximum recording time | 10 hours | 20 hours | 30 hours | 60 hours | 180 hours | 300 hours | 600 hours |

The standard interval is five minutes.

The interval can be set using the data logger management program sold separately.

(2) Alarm trend

When an alarm is triggered, this function records the changes in measured concentration for 30 minutes before and after the alarm occurred (one hour in total).

Alarm trend records peak values (maximum values for H-HH and minimum values for L-H or L-LL alarm types) over five-second periods at five-second intervals.

The eight most recent data items are recorded.

If the number of items exceeds 8, the oldest data will be overwritten by the latest data.

(3) Alarm event

Records alarm occurrences as events.

This function records the time the alarm was triggered, the detection target gas, and the type of alarm event.

The 100 most recent events are recorded.

If the number of items exceeds 100, the oldest data will be overwritten by the latest data.

(4) Trouble event

Records fault alarm occurrences as events.

This function records the time when the fault alarm was triggered, the detection target gas, device information, and the type of trouble event.

The 100 most recent events are recorded.

If the number of items exceeds 100, the oldest data will be overwritten by the latest data.

(5) Adjustment history

Records data when adjustment is performed.

Records the adjustment time and concentrations before and after adjustment.

The 100 most recent adjustment history data items are recorded.

If the number of items exceeds 100, the oldest data will be overwritten by the latest data.

NOTE

- ▶ If a USB connection is detected while the date and time or battery voltage is displayed after the power is turned on, the product enters communication mode. Communication mode can also be selected by pressing the RESET/▼ and DISP/ESC buttons together while the date and time or battery voltage is displayed during startup.
 - ▶ A fault alarm will be triggered if no communication connection can be confirmed for a preset duration in communication mode. If this occurs, either repeat the communication connection or turn off the power for the product.
-

12-2 100 %LEL conversion list

The following table shows the standard conversion for 100 %LEL and ppm. The 100 %LEL values are standard values for both Japan Ex and ATEX/IECEx models.

| Gas type | | Standard | IEC | ISO |
|------------------------|--|-------------------------|------------|------------|
| Methane | CH ₄ | 50,000 ppm ² | 44,000 ppm | 44,000 ppm |
| Isobutane | HC (i-C ₄ H ₁₀) | 18,000 ppm ³ | 13,000 ppm | 15,000 ppm |
| Hydrogen | H ₂ | 40,000 ppm ² | 40,000 ppm | 40,000 ppm |
| Methanol | CH ₃ OH | 55,000 ppm ¹ | 60,000 ppm | 60,000 ppm |
| Acetylene | C ₂ H ₂ | 15,000 ppm ¹ | 23,000 ppm | 23,000 ppm |
| Ethylene | C ₂ H ₄ | 27,000 ppm ² | 23,000 ppm | 24,000 ppm |
| Ethane | C ₂ H ₆ | 30,000 ppm ² | 24,000 ppm | 24,000 ppm |
| Ethanol | C ₂ H ₅ OH | 33,000 ppm ² | 31,000 ppm | 31,000 ppm |
| Propylene | C ₃ H ₆ | 20,000 ppm ² | 20,000 ppm | 18,000 ppm |
| Acetone | C ₃ H ₆ O | 21,500 ppm ¹ | 25,000 ppm | 25,000 ppm |
| Propane | C ₃ H ₈ | 20,000 ppm ¹ | 17,000 ppm | 17,000 ppm |
| Butadiene | C ₄ H ₆ | 11,000 ppm ¹ | 14,000 ppm | 14,000 ppm |
| Cyclopentane | C ₅ H ₁₀ | 14,000 ppm ⁴ | 14,000 ppm | 14,000 ppm |
| Benzene | C ₆ H ₆ | 12,000 ppm ¹ | 12,000 ppm | 12,000 ppm |
| N-hexane | n-C ₆ H ₁₄ | 12,000 ppm ¹ | 10,000 ppm | 10,000 ppm |
| Toluene | C ₇ H ₈ | 12,000 ppm ² | 10,000 ppm | 10,000 ppm |
| N-heptane | n-C ₇ H ₁₆ | 11,000 ppm ² | 8,500 ppm | 8,000 ppm |
| Xylene | C ₈ H ₁₀ | 10,000 ppm ² | 10,000 ppm | 10,000 ppm |
| N-nonane | n-C ₉ H ₂₀ | 7,000 ppm ⁵ | 7,000 ppm | 7,000 ppm |
| Ethyl acetate | EtAc | 21,000 ppm ¹ | 20,000 ppm | 20,000 ppm |
| Isopropyl alcohol | IPA | 20,000 ppm ² | 20,000 ppm | 20,000 ppm |
| Methyl ethyl ketone | MEK | 18,000 ppm ² | 15,000 ppm | 15,000 ppm |
| Methyl methacrylate | MMA | 17,000 ppm ² | 17,000 ppm | 17,000 ppm |
| Dimethyl ether | DME | 30,000 ppm ¹ | 27,000 ppm | 27,000 ppm |
| Methyl isobutyl ketone | MIBK | 12,000 ppm ³ | 12,000 ppm | 12,000 ppm |
| Tetrahydrofuran | THF | 20,000 ppm ² | 15,000 ppm | 15,000 ppm |
| Normal pentane | n-C ₅ H ₁₂ | 15,000 ppm ² | 11,000 ppm | 11,000 ppm |

*1: Recommended Practices for Explosion-Protected Electrical Installations in General Industries (NIIS/1985)

*2: Recommended Practices for Explosion-Protected Electrical Installations in General Industries (NIIS/2006)

*3: Technical recommendations of the Research Institute of Industrial Safety (NIIS/1994)

*4: Chemical Safety Management Data Book (The Chemical Daily Co., Ltd.)

*5: Product Safety Data Sheet (Eishin Kagaku Co., Ltd.)

12-3 Zero suppression function

Gas sensors are affected by environmental factors such as temperature and humidity characteristics. They are also substantially affected by the interference of the detection target gas. Environmental and interference effects may cause the product reading to fluctuate around zero.

The zero suppression function is designed to suppress notifications of fluctuations around zero. The function suppresses reading fluctuations below the set value and displays zero instead (or 20.9 % for the oxygen sensor).

NOTE

- ▶ The default setting is enabled. To disable the setting, use the MT-9000 Series Setup Program sold separately and refer to the operating manual. If the setting is disabled, readings may fluctuate due to output variations attributable to sensor characteristics.
- ▶ Even when enabled, the zero suppression function will function only in measurement mode and display mode.
- ▶ All readings in the range from zero to the negative suppression value indicated in the following table are suppressed. Values from the negative suppression value to the M OVER value will be displayed, but accurate measurements cannot be achieved in this state. Fresh air adjustment should be performed. For information on M OVER values, refer to '4-2 Gas alarm setpoints'.

The zero suppression function settings are as follows:

<R sensors>

| Sensor | Detection target gas | Suppression value | Suppression type | Negative suppression value | Negative suppression type |
|----------|--|-----------------------------------|------------------|----------------------------|---------------------------|
| ESR-X13P | Oxygen (O ₂) | 20.9 % ± 0.5 % (20.4 – 21.4 %) | Cut-air | -0.5 % | Cut-off |
| ESR-A13i | Hydrogen sulfide (H ₂ S) (low concentration) | 0.3 ppm | Cut-off | -1.5 ppm | Cut-off |
| ESR-A13P | Carbon monoxide (CO) | 2 ppm | Cut-off | -25 ppm | Cut-off |

<F sensors>

| Sensor | Detection target gas | Suppression value | Suppression type | Negative suppression value | Negative suppression type |
|-------------|---|-------------------|------------------|----------------------------|---------------------------|
| NCF-6322P | Methane (CH ₄) Japan Ex model Isobutane (HC (i-C ₄ H ₁₀)) Hydrogen (H ₂) Acetylene (C ₂ H ₂) | 2 – 5 %LEL | Smoothing | -5 %LEL | Cut-off |
| NCF-6322P M | Methane (CH ₄) ATE/IECEx model | | | | |
| TEF-7520P | Methane (CH ₄) Isobutane (HC (i-C ₄ H ₁₀)) Hydrogen (H ₂) | 0.9 vol% | Cut-off | -5.0 vol% | Cut-off |
| IRF-4341 | Methane (CH ₄) | N/A | N/A | -5 %LEL | Cut-off |
| IRF-4345 | Isobutane (HC (i-C ₄ H ₁₀)) | N/A | N/A | -5 %LEL | Cut-off |
| IRF-4443 | Carbon dioxide (CO ₂) | N/A | N/A | -2 vol% | Cut-off |
| IRF-4433 | Carbon dioxide (CO ₂) | N/A | N/A | -1,000 ppm | Cut-off |
| ESF-A24R2 | Hydrogen sulfide (H ₂ S) (high concentration) | 20 ppm | Cut-off | -50 ppm | Cut-off |
| ESF-B242 | Ammonia (NH ₃) | 10.0 ppm | Cut-off | -5.0 ppm | Cut-off |
| ESF-C930 | Chlorine (Cl ₂) | 0.09 ppm | Cut-off | -0.08 ppm | Cut-off |

| Sensor | Detection target gas | Suppression value | Suppression type | Negative suppression value | Negative suppression type |
|-----------|--|-------------------|------------------|----------------------------|---------------------------|
| ESF-B249 | Ozone (O ₃) | 0.035 ppm | Cut-off | -0.030 ppm | Cut-off |
| ESF-A24E2 | Hydrogen chloride (HCl) | 0.35 ppm | Cut-off | -0.30 ppm | Cut-off |
| ESF-A24D4 | Sulfur dioxide (SO ₂) | 0.4 ppm | Cut-off | -5.0 ppm | Cut-off |
| ESF-A24D | Hydrogen cyanide (HCN) Japan Ex model | 0.9 ppm | Cut-off | -0.8 ppm | Cut-off |
| ESF-A24DX | Hydrogen cyanide (HCN) ATEX/IECEX model | 0.9 ppm | Cut-off | -0.8 ppm | Cut-off |
| PIF-001 | Volatile organic compounds (VOC, 10.6 eV, ppb) | N/A | N/A | -20 ppm | Cut-off |
| PIF-002 | Volatile organic compounds (VOC, 10.6 eV, ppm) | N/A | N/A | -2,000 ppm | Cut-off |
| PIF-003 | Volatile organic compounds (VOC, 10.0 eV, ppm) | N/A | N/A | -50 ppm | Cut-off |

12-4 Zero follower function

The sensors used in the product may exhibit zero point fluctuations when used for extended periods.

The zero follower function stabilizes the zero point by adjusting reading fluctuations at the zero point that result from extended periods of use.

| | |
|---|---|
| Combustible gas sensors | The sensor output is tracked to zero the value if output fluctuations occur below the stipulated value when the power is turned on. |
| Sensors other than combustible gas sensors | The sensor output is tracked to zero the value if the sensor output repeatedly drops below zero when the power is turned on. |

* The zero follower function is enabled when the power is turned on.

NOTE

- ▶ The default setting is enabled. To disable the setting, use the MT-9000 Series Setup Program sold separately and refer to the operating manual. When the setting is disabled, the zero point may fluctuate due to output variation caused by the sensor characteristics.
- ▶ The zero follower function is not enabled for the oxygen sensor.

12-5 List of interference gases for electrochemical type sensors

This is a list of interference gases for electrochemical type oxygen sensors and toxic gas sensors. The values indicated here are representative values measured in a laboratory environment using new sensors and filters. Note that the condition of the sensors and filters and environmental factors at the site such as temperature and humidity will affect susceptibility to interference. These figures may differ from the actual values. Use them as reference values to identify the presence of interference gases and the degree of interference influence.



CAUTION

- A false alarm may occur with measurements performed in an environment where strong interference gases are present.

<ESR-X13P (O₂)>

| Gas name | Chemical formula | Gas concentration | Reading |
|------------------|--|-------------------|------------------------|
| Hydrogen | H ₂ | 2 vol% | -2.8 % O ₂ |
| Carbon monoxide | CO | 2,980 ppm | 0.2 % O ₂ |
| Sulfur dioxide | SO ₂ | 1,010 ppm | 0.3 % O ₂ |
| Hydrogen sulfide | H ₂ S | 292 ppm | 0.1 % O ₂ |
| Methane | CH ₄ | 50 vol% | -0.03 % O ₂ |
| Isobutane | HC (i-C ₄ H ₁₀) | 50 vol% | -0.14 % O ₂ |

<ESR-A13i (H₂S)>

| Gas name | Chemical formula | Gas concentration | Reading |
|-------------------|--|-------------------|---------|
| Sulfur dioxide | SO ₂ | 25.0 ppm | 0.0 ppm |
| Hydrogen chloride | HCl | 3.2 ppm | 0.0 ppm |
| Ammonia | NH ₃ | 38.6 ppm | 0.0 ppm |
| Ozone | O ₃ | 0.48 ppm | 0.0 ppm |
| Chlorine | Cl ₂ | 2.0 ppm | 0.0 ppm |
| Methane | CH ₄ | 1.26 vol% | 0.0 ppm |
| Isobutane | HC (i-C ₄ H ₁₀) | 0.45 vol% | 0.0 ppm |
| Isobutylene | C ₄ H ₈ | 1,000 ppm | 0.1 ppm |

<ESR-A13P (CO)>

| Gas name | Chemical formula | Gas concentration | Reading |
|-------------------|--|-------------------|---------|
| Hydrogen | H ₂ | 100 ppm | 11 ppm |
| Sulfur dioxide | SO ₂ | 30 ppm | 0 ppm |
| Hydrogen sulfide | H ₂ S | 30 ppm | 0 ppm |
| Hydrogen chloride | HCl | 11.7 ppm | -1 ppm |
| Hydrogen cyanide | HCN | 1.8 ppm | -1 ppm |
| Ammonia | NH ₃ | 255 ppm | 1 ppm |
| Ozone | O ₃ | 1.8 ppm | 0 ppm |
| Chlorine | Cl ₂ | 0.8 ppm | 0 ppm |
| Methane | CH ₄ | 1.25 vol% | 0 ppm |
| Isobutane | HC (i-C ₄ H ₁₀) | 0.45 vol% | -1 ppm |

<ESF-A24R2 (H₂S)>

| Gas name | Chemical formula | Gas concentration | Reading |
|-------------------|------------------|-------------------|---------|
| Carbon monoxide | CO | 3,020 ppm | 182 ppm |
| Carbon dioxide | CO ₂ | 20 vol% | -1 ppm |
| Sulfur dioxide | SO ₂ | 100 ppm | 20 ppm |
| Hydrogen chloride | HCl | 15 ppm | -2 ppm |
| Ammonia | NH ₃ | 400 ppm | 1 ppm |
| Ozone | O ₃ | 1.1 ppm | -1 ppm |
| Chlorine | Cl ₂ | 5.0 ppm | 1 ppm |

<ESF-B242 (NH₃)>

| Gas name | Chemical formula | Gas concentration | Reading |
|-------------------|------------------|-------------------|----------|
| Carbon dioxide | CO ₂ | 2,500 ppm | 1.8 ppm |
| Sulfur dioxide | SO ₂ | 10 ppm | -5.3 ppm |
| Hydrogen sulfide | H ₂ S | 3.0 ppm | -2.5 ppm |
| Hydrogen chloride | HCl | 3.2 ppm | -2.6 ppm |
| Ozone | O ₃ | 2.2 ppm | 4.5 ppm |
| Chlorine | Cl ₂ | 1.6 ppm | -0.8 ppm |

<ESF-C930 (Cl₂)>

| Gas name | Chemical formula | Gas concentration | Reading |
|-------------------|------------------|-------------------|-----------|
| Carbon monoxide | CO | 2,970 ppm | 0.00 ppm |
| Carbon dioxide | CO ₂ | 2,500 ppm | 0.01 ppm |
| Hydrogen sulfide | H ₂ S | 8.0 ppm | -0.04 ppm |
| Hydrogen chloride | HCl | 15 ppm | 0.02 ppm |
| Hydrogen cyanide | HCN | 7.8 ppm | -0.01 ppm |
| Ammonia | NH ₃ | 75 ppm | -0.02 ppm |
| Ozone | O ₃ | 2.4 ppm | 0.24 ppm |
| Methane | CH ₄ | 100 vol% | -0.02 ppm |

<ESF-B249 (O₃)>

| Gas name | Chemical formula | Gas concentration | Reading |
|-------------------|------------------|-------------------|-----------|
| Carbon monoxide | CO | 2,950 ppm | 0.00 ppm |
| Carbon dioxide | CO ₂ | 2,500 ppm | 0.02 ppm |
| Sulfur dioxide | SO ₂ | 0.50 ppm | 0.01 ppm |
| Hydrogen sulfide | H ₂ S | 1.0 ppm | -0.04 ppm |
| Hydrogen chloride | HCl | 15 ppm | 0.58 ppm |
| Ammonia | NH ₃ | 75 ppm | -0.06 ppm |
| Chlorine | Cl ₂ | 1.5 ppm | 2.01 ppm |
| Methane | CH ₄ | 50,000 ppm | 0.00 ppm |

<ESF-A24E2 (HCl)>

| Gas name | Chemical formula | Gas concentration | Reading |
|------------------|------------------|-------------------|-----------|
| Carbon monoxide | CO | 2,950 ppm | 0.07 ppm |
| Carbon dioxide | CO ₂ | 50,000 ppm | -0.02 ppm |
| Sulfur dioxide | SO ₂ | 10 ppm | 0.34 ppm |
| Hydrogen sulfide | H ₂ S | 1.6 ppm | 1.14 ppm |
| Ammonia | NH ₃ | 400 ppm | -0.19 ppm |
| Ozone | O ₃ | 2.4 ppm | -0.05 ppm |
| Chlorine | Cl ₂ | 2.5 ppm | 0.40 ppm |
| Methane | CH ₄ | 25,000 ppm | -0.01 ppm |

<ESF-A24D4 (SO₂)>

| Gas name | Chemical formula | Gas concentration | Reading |
|-------------------|------------------|-------------------|----------|
| Carbon monoxide | CO | 3,020 ppm | 16.4 ppm |
| Carbon dioxide | CO ₂ | 20 vol% | 0.1 ppm |
| Hydrogen sulfide | H ₂ S | 1,010 ppm | 0.7 ppm |
| Hydrogen chloride | HCl | 15 ppm | 0.1 ppm |
| Ammonia | NH ₃ | 400 ppm | -0.1 ppm |
| Ozone | O ₃ | 1.1 ppm | -0.8 ppm |
| Chlorine | Cl ₂ | 5.0 ppm | 0.1 ppm |
| Methane | CH ₄ | 100 vol% | -0.1 ppm |

<ESF-A24D (HCN) Japan Ex model, ESF-A24DX (HCN) ATEX/IECEx model >

| Gas name | Chemical formula | Gas concentration | Reading |
|-------------------|------------------|-------------------|----------|
| Carbon monoxide | CO | 3,040 ppm | 15.5 ppm |
| Carbon dioxide | CO ₂ | 20 vol% | 0.3 ppm |
| Sulfur dioxide | SO ₂ | 6.0 ppm | 20.4 ppm |
| Hydrogen sulfide | H ₂ S | 1.0 ppm | 3.6 ppm |
| Hydrogen chloride | HCl | 15 ppm | 16.1 ppm |
| Ammonia | NH ₃ | 400 ppm | 0.3 ppm |
| Ozone | O ₃ | 1.8 ppm | -8.5 ppm |
| Chlorine | Cl ₂ | 1.5 ppm | -2.9 ppm |
| Methane | CH ₄ | 100 vol% | 0.4 ppm |

12-6 Radio law certification



This product is certified as complying with radio laws in individual countries and regions as follows. The following actions are prohibited by radio laws. The user and/or retailer may be subject to punishment if prohibited actions are committed.

- Use in countries or regions in which radio law certification has not been obtained
- Sale in countries or regions in which radio law certification has not been obtained
- Disassembly or modification of the product
- Removal of certification labels from the product

If this product is used aboard marine vessels, the radio laws of the country bordering the territorial waters shall apply. In such cases, use shall be prohibited in countries or regions in which radio law certification has not been obtained.

Check to confirm that industrial, scientific, and medical equipment (e.g., microwave ovens), on-premises radio stations for mobile identification used in plant manufacturing lines (radio stations requiring a license), and specified low-power radio stations are not operated in the frequency band (2.4 GHz) used by the product. If the product causes radio interference to a radio station for mobile identification, take measures to eliminate radio interference—for example, using the product in a different location or stopping radio emissions.

Wireless specifications

| | |
|--|--|
| Wireless communication | Protocol: Bluetooth Low Energy Version: Ver. 4.2 Frequency: 2,402 MHz to 2,480 MHz Modulation: FSK Output: Maximum 6 dBm |
| Radio law certification (Country/region) | Details |
| Radio Act (Japan) | This product contains radio equipment certified to comply with technical standards in accordance with the Radio Act. Accordingly, a radio station license is not required when using this product.  Construction design certification number: 001-A07864 Wireless frequency: 2,402 MHz to 2,480 MHz Maximum wireless output: 6 dBm |
| RE Directive (EU countries) |  We declare that this equipment complies with the basic requirements of Directive 2014/53/EU and other relevant provisions. Connect to the network with radio waves of frequency 2.4 GHz band and maximum output 6 dBm. |
| FCC compliance (United States) | This device complies with part 15 of the FCC Rules. Operation is subject to the following two conditions: (1) This device may not cause harmful interference, and (2) this device must accept any interference received, including interference that may cause undesired operation. FCC CAUTION Changes or modifications not expressly approved by the party responsible for compliance could void the user's authority to operate the equipment. |

| | |
|------------------------|---|
| | <p>Note: This equipment has been tested and found to comply with the limits for a Class A digital device, pursuant to part 15 of the FCC Rules. These limits are designed to provide reasonable protection against harmful interference when the equipment is operated in a commercial environment. This equipment generates, uses, and can radiate radio frequency energy and, if not installed and used in accordance with the instruction manual, may cause harmful interference to radio communications. Operation of this equipment in a residential area is likely to cause harmful interference in which case the user will be required to correct the interference at his own expense.</p> <p>This equipment complies with FCC radiation exposure limits set forth for an uncontrolled environment and meets the FCC radio frequency (RF) Exposure Guidelines. This equipment has very low levels of RF energy that is deemed to comply without testing of specific absorption rate (SAR).</p> |
| IC compliance (Canada) | <p>This device complies with Industry Canada's license-exempt RSSs. Operation is subject to the following two conditions: This device may not cause interference; and This device must accept any interference, including interference that may cause undesired operation of the device.</p> <p>Le présent appareil est conforme aux CNR d'Industrie Canada applicables aux appareils radio exempts de licence. L'exploitation est autorisée aux deux conditions suivantes: l'appareil ne doit pas produire de brouillage; l'utilisateur de l'appareil doit accepter tout brouillage radioélectrique subi, même si le brouillage est susceptible d'en compromettre le fonctionnement.</p> <p>This equipment complies with IC radiation exposure limits set forth for an uncontrolled environment and meets RSS-102 of the IC radio frequency (RF) Exposure rules. This equipment has very low levels of RF energy that is deemed to comply without testing of specific absorption rate (SAR).</p> <p>Cet équipement est conforme aux limites d'exposition aux rayonnements énoncées pour un environnement non contrôlé et respecte les règles d'exposition aux fréquences radioélectriques (RF) CNR-102 de l'IC. Cet équipement émet une énergie RF très faible qui est considérée comme conforme sans évaluation du débit d'absorption spécifique (DAS).</p> |
| ACMA (Australia) | <p>Model: GX-9000, GX-9000H</p>  |

12-7 Limited Warranty and Limitation Liability

RIKEN KEIKI CO., LTD. (RIKEN) warrants the product to be free from defects in material and workmanship under normal use and service for a period of the number of years to be listed in "Table: List of warranty years", beginning on the date of shipment to the buyer. This warranty extends only to the sale of new and unused products to the original buyer. RIKEN's warranty obligation is limited, at RIKEN's option, to repair or replacement of a defective product that is returned to a RIKEN KEIKI Quality control center located in Japan within the warranty period. In no event shall RIKEN's liability hereunder exceed the purchase price actually paid by the buyer for the Product.

This warranty does not include:

- a) fuses, disposable batteries or the routine replacement of parts due to the normal wear and tear of the product arising from use;
- b) any product which in RIKEN's opinion, has been misused, altered, neglected or damaged, by accident or abnormal conditions of operation, handling or use;
- c) any damage or defects attributable to repair of the product by any person other than an authorized dealer, or the installation of unapproved parts on the product; or

The obligations set forth in this warranty are conditional on:

- a) proper storage, installation, calibration, use, maintenance and compliance with the product manual instructions and any other applicable recommendations of RIKEN;
- b) the buyer promptly notifying RIKEN of any defect and, if required, promptly making the product available for correction. No goods shall be returned to RIKEN until receipt by the buyer of shipping instructions from RIKEN; and
- c) the right of RIKEN to require that the buyer provide proof of purchase such as the original invoice, bill of sale or packing slip to establish that the product is within the warranty period.

THE BUYER AGREES THAT THIS WARRANTY IS THE BUYER'S SOLE AND EXCLUSIVE REMEDY AND IS IN LIEU OF ALL OTHER WARRANTIES, EXPRESS OR IMPLIED, INCLUDING BUT NOT LIMITED TO ANY IMPLIED WARRANTY OF MERCHANTABILITY OR FITNESS FOR A PARTICULAR PURPOSE. RIKEN SHALL NOT BE LIABLE FOR ANY SPECIAL, INDIRECT, INCIDENTAL, OR BASED ON CONTRACT, TORT OR RELIANCE OR ANY OTHER THEORY.

Since some countries or states do not allow limitation of the term of an implied warranty, or exclusion or limitation of incidental or consequential damages, the limitations and exclusions of this warranty may not apply to every buyer. If any provision of this warranty is held invalid or unenforceable by a court of competent jurisdiction, such holding will not affect the validity or enforceability of any other provision.

Contacting RIKEN KEIKI

Email us at: intdept@rikenkeiki.co.jp

Visit RIKEN KEIKI website at: <https://www.rikenkeiki.com/>

JAPAN: +81-3-3966-1113

Table: List of warranty years

| Product warranty | | |
|-------------------------|---|------------------------|
| 3 years | | |
| Sensor warranty | | |
| Sensor model | Detection target gas | Warranty period |
| NCF-6322P | Methane (CH ₄) Japan Ex model, isobutane (HC (i-C ₄ H ₁₀)), hydrogen (H ₂), acetylene (C ₂ H ₂) | 3 years |
| NCF-6322P M | Methane (CH ₄) ATEX/IECEx model | 3 years |
| TEF-7520P | Methane (CH ₄), isobutane (HC (i-C ₄ H ₁₀)), hydrogen (H ₂) | 3 years |
| IRF-4341 | Methane (CH ₄) | 3 years |
| IRF-4345 | Isobutane (HC (i-C ₄ H ₁₀)) | 3 years |
| IRF-4443 | Carbon dioxide (CO ₂) | 3 years |
| IRF-4433 | Carbon dioxide (CO ₂) | 3 years |
| ESR-X13P | Oxygen (O ₂) | 3 years |
| ESR-A13i | Hydrogen sulfide (H ₂ S) low concentration | 3 years |
| ESR-A13P | Carbon monoxide (CO) | 3 years |
| ESF-A24R2 | Hydrogen sulfide (H ₂ S) high concentration | 3 years |
| ESF-B242 | Ammonia (NH ₃) | 2 years |
| ESF-C930 | Chlorine (Cl ₂) | 3 years |
| ESF-B249 | Ozone (O ₃) | 1 year |
| ESF-A24E2 | Hydrogen chloride (HCl) | 3 years |
| ESF-A24D4 | Sulfur dioxide (SO ₂) | 3 years |
| ESF-A24D | Hydrogen cyanide (HCN) Japan Ex model | 3 years |
| ESF-A24DX | Hydrogen cyanide (HCN) ATEX/IECEx model | 3 years |
| PIF-001 | Volatile organic compounds (VOC, 10.6 eV, ppb) | 1 year |
| PIF-002 | Volatile organic compounds (VOC, 10.6 eV, ppm) | 1 year |
| PIF-003 | Volatile organic compounds (VOC, 10.0 eV, ppm) | 1 year |

Revision history

| Issue | Revision details | Issue date |
|-------|---|------------|
| 0 | First issue | 2023/11/6 |
| 1 | Cl2 sensor model changed to ESF-C930, 3-1 Aluminum trunk case added, DoC updated | 2024/3/6 |
| 2 | 2-4 Explosion-proofing guideline compliance corrected | 2024/3/14 |
| 3 | DoC updated | 2024/5/31 |
| 4 | ATEX/IECEX model CH4 sensor NCF-6322P⇒NCF-6322P M, Recommended sensor replacement interval of VOC sensor updated, 8-6-3 Replacing of the main unit's filter/sensor addition | 2025/5/7 |
| 5 | VOC conversion gas list deleted, 6-4-3 Volatile organic compound (VOC) conversion gas selection correction | 2025/6/9 |
| 6 | Information on JG type approval addition, 8-6-1 Periodic replacement parts corrected, CE declaration deleted, 9-3 Product disposal corrected | 2025/6/11 |
| 7 | ESF-A24DX (HCN) ATEX/IECEX model addition | 2025/12/25 |
| 8 | IRF-4433 (CO ₂) addition | 2026/4/10 |