



PT0E-1669

**Gas Suction Pump Unit  
RP-3R/RP-3R (Pro)  
RP-3R (S)/RP-3R (Pro/S)  
Operating Manual  
(PT0E-166)**

**RIKEN KEIKI Co., Ltd.**

2-7-6 Azusawa, Itabashi-ku, Tokyo, 174-8744, Japan

Phone : +81-3-3966-1113

Fax : +81-3-3558-9110

E-mail : [intdept@rikenkeiki.co.jp](mailto:intdept@rikenkeiki.co.jp)

Web site : <https://www.rikenkeiki.co.jp/>

## Contents

1.	Product Overview	
1-1.	Introduction .....	3
1-2.	Intended use .....	4
1-3.	DANGER, WARNING, CAUTION, and NOTE.....	4
1-4.	Checking standards and explosion-proof specifications .....	4
2.	Important Safety Information	
2-1.	Danger items .....	5
2-2.	Warnings .....	5
2-3.	Precautions .....	7
2-4.	Safety information .....	8
3.	Product Configuration	
3-1.	Main unit and standard accessories.....	11
3-2.	Part names and functions.....	11
3-2-1.	RP-3R or RP-3R (Pro).....	11
3-2-2.	RP-3R (S) or RP-3R (Pro/S) .....	13
4.	Usage Procedures	
4-1.	Usage note .....	15
4-2.	Preparations for startup.....	15
4-3.	Battery insertion and replacement.....	15
4-4.	Attaching the GX-3R or GX-3R Pro.....	17
4-4-1.	RP-3R or RP-3R (Pro).....	17
4-4-2.	RP-3R (S) or RP-3R (Pro/S) .....	19
4-5.	Removing the GX-3R or GX-3R Pro .....	21
4-5-1.	RP-3R or RP-3R (Pro).....	21
4-5-2.	RP-3R (S) or RP-3R (Pro/S) .....	21
4-6.	Startup and shutdown procedures .....	22
4-7.	Switching pump suction flow rates .....	22
4-8.	Fault alarms .....	23
5.	Maintenance	
5-1.	Maintenance intervals and items.....	24
5-2.	Cleaning procedure .....	25
5-3.	Filter replacement.....	25
5-4.	Periodic replacement parts list .....	26
6.	Storage and Disposal	
6-1.	Procedures for storage or when not in use for extended periods ...	27
6-2.	Procedure for reuse.....	27
6-3.	Product disposal.....	27
7.	Troubleshooting.....	29
8.	Product Specifications.....	30

# Product Overview

## 1-1. Introduction

Thank you for purchasing the RP-3R/RP-3R (Pro)/RP-3R (S)/RP-3R (Pro/S) Gas Suction Pump Unit (“product” hereinafter). Please confirm that the model number of the product you purchased matches the model number of the product covered by this manual.

The product should be used only by fully-trained personnel. The maintenance procedures described in this manual should be performed only by fully-trained personnel. Any maintenance procedure not described in this manual must be performed by Riken Keiki or our certified service engineers. Please contact Riken Keiki.

This manual describes how to use the product and provides product specifications. Make sure you have read and fully understood the contents of this manual before using the product. This applies both to first-time users and those who have previously used the product. Keep this manual in a safe place for future reference.

The contents of this manual are subject to change without notice to allow product improvements. Any duplication or reproduction of this manual without permission is prohibited, whether in whole or in part.

The product is designed to be used by being attached to the GX-3R/GX-3R Pro Portable Gas Monitor (available separately). Refer to the following manuals for the separately sold products along with this manual:

- 1) GX-3R Portable Gas Monitor Operating Manual (PT0E-176)
- 2) GX-3R Pro Portable Gas Monitor Operating Manual (PT0E-177)



Regardless of the warranty period, Riken Keiki does not accept any liability for accidents or damage resulting from use of the product. Be sure to read the warranty policy set forth on the warranty.

## 1-2. Intended use

The product is designed to be attached to the GX-3R/GX-3R Pro Portable Gas Monitor (available separately) to draw in gas using the built-in pump. The RP-3R and RP-3R (S) can be connected to the GX-3R. The RP-3R (Pro) and RP-3R (Pro/S) can be connected to the GX-3R Pro.

## 1-3. DANGER, WARNING, CAUTION, and NOTE

This manual uses the following headings to ensure safe and effective work:

 <b>DANGER</b>	This indicates situations in which improper handling may result in fatal or serious injury to persons or serious damage to property.
 <b>WARNING</b>	This indicates situations in which improper handling may result in serious injury to persons or serious damage to property.
 <b>CAUTION</b>	This indicates situations in which improper handling may result in minor injury to persons or minor damage to property.
<b>NOTE</b>	This indicates handling tips.

## 1-4. Checking standards and explosion-proof specifications

The product specifications will vary depending on the specific standards and explosion-proof certification. Check actual product specifications before use. For CE/UKCA marking models, please refer to the “Declaration of Conformity” provided at the end of this manual.

Check the nameplates affixed as shown in the following figures for product specifications.

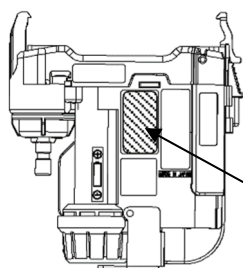

Type examination certificate marking

Nameplate for explosion-proof electrical equipment type certified (Japanese explosion-proof specifications) product

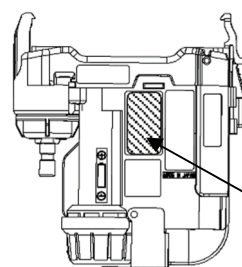

Ex marking/  
CE marking  
UKCA marking

Nameplate for ATEX/IECEx/UKEX specifications

# Important Safety Information

## 2-1. Danger items



### DANGER

#### Explosion-proof

- Do not modify or alter circuits or the configuration.
- When carrying the product to use in potentially hazardous locations, follow the following general safety precautions to prevent hazards due to static electricity buildups:
  - ① Wear antistatic work clothing and conductive footwear (antistatic work shoes).
  - ② For use indoors, make sure the space has a conductive floor (leakage resistance not exceeding 10 MΩ).
- The product is rated as follows:  
Power supply: 1.5 V DC



RP-3



RP-3R (Pro)



RP-3R (S)



RP-3R (Pro/S)

## 2-2. Warnings



### WARNING

#### If an abnormality occurs

If an abnormality is discovered in the product, contact Riken Keiki immediately.

Visit our website for information on the nearest Riken Keiki office.

Website: <https://www.rikenkeiki.co.jp/>



## **WARNING**

### **Usage**

- When measuring inside manholes or enclosed locations, never lean over the manhole entrance or attempt to peer inside. There is a danger that oxygen-deficient air or other gases may be discharged from such locations.
- Oxygen-deficient air may be discharged from the gas outlet. Never breathe in this air. High-concentration (LEL or higher) gas may be discharged. Be sure to maintain a safe distance from flame sources.

### **Battery level check**

- The battery may become depleted if not used for a long period of time. Always replace with a new battery before use.
- If a low battery voltage alarm is issued during use, turn off the power and move immediately to a nonhazardous location to replace the battery.

### **Miscellaneous**

- Do not dispose of the product into fire. Do not attempt to wash the product, either in a washing machine or an ultrasonic cleaning machine.
- Do not block the buzzer opening. Doing so will muffle or silence the audible warning.
- The product is designed to draw in gas at atmospheric pressure. There is a danger that detection target gas may leak from inside the product if an excessive pressure is applied to the gas inlet of the product. Be careful to avoid excessive pressure during use.
- Do not connect directly to locations pressurized above atmospheric pressure. Doing so may result in damage to the internal pipes.

## 2-3. Precautions



### CAUTION

- Avoid use in locations where the product may be splashed with oil or chemicals. Avoid deliberate immersion in water.
- Avoid using the product in locations where the product may be splashed with oil, chemicals, or other liquids.
- Take care to keep water such as rainwater from entering via the suction part.
- Do not place the product in locations where water or mud may accumulate. Placing the product in such locations may result in water or mud entering via the buzzer opening or gas connector, resulting in malfunctions.
- Avoid use in locations where temperatures are below  $-20^{\circ}\text{C}$  or exceed  $50^{\circ}\text{C}$ .
- The operating temperature range for the product is between  $-20^{\circ}\text{C}$  and  $+50^{\circ}\text{C}$ . Avoid use under conditions beyond the operating range.
- Avoid using the product for extended periods in locations exposed to direct sunlight.
- Avoid storing the product inside parked vehicles in hot weather.
- Do not use walkie-talkies or other radio transmitters near the product.
- The product's functions may be affected by radio waves emitted from walkie-talkies or other radio transmitters used nearby. Do not use walkie-talkies or other radio transmitters close to the product.
- Avoid using the product close to devices that emit strong electromagnetic waves (e.g., high frequency or high voltage devices).
- Be sure to perform regular maintenance.
- The product is a safety device and must be regularly maintained to ensure safety. Continuing to use the product without regular maintenance may prevent accurate gas detection.
- Pressing buttons unnecessarily may change the settings, preventing alarms from activating correctly. Operate the gas monitor using only the procedures described in this operating manual.

## 2-4. Safety information

Observe the following points to ensure performance as an explosion-proof product:

### Product overview

- The RP-3R series (RP-3R, RP-3R (Pro), RP-3R (S), and RP-3R (Pro/S)) pump units are suction pumps that draw in and feed gas to the GX-3R or GX-3R Pro. Although the GX-3R and GX-3R Pro are diffusion type gas monitors, they can be used as suction type monitors when connected to the RP-3R/RP-3R (Pro)/RP-3R (S)/RP-3R (Pro/S).
- The user should not attempt to replace the chamber unit.
- The built-in micropump is used to draw in gas.
- Only AA alkaline batteries (LR6) manufactured by Toshiba can be used with the product.

<ATEX/IECEX/UKEX specifications>

<b>Explosion-proof construction</b>	Intrinsically safe explosion-proof construction
<b>Explosion-proof class</b>	<ul style="list-style-type: none"><li>• Ex ia IIC T4 Ga -20°C ≤ Ta ≤ +50°C (using L6 battery)</li><li>Ex ia IIC T4/T3 Ga -20°C ≤ Ta ≤ +40°C/+50°C (using MN1500 battery)</li><li>•  II 1 G Ex ia IIC T4 Ga -20°C ≤ Ta ≤ +50°C (using L6 battery)</li><li>II 1 G Ex ia IIC T4/T3 Ga -20°C ≤ Ta ≤ +40°C/+50°C (using MN1500 battery)</li></ul>
<b>Electrical specifications</b>	Alkaline battery: Toshiba LR6 or Duracell MN1500
<b>Certificate numbers</b>	<ul style="list-style-type: none"><li>• IECEX: IECEX PRE 17.0070</li><li>• ATEX: Presafe 17 ATEX 11584</li><li>• UKEX: DNV 22 UKEX 25921</li></ul>
<b>Applicable standards</b>	<ul style="list-style-type: none"><li>• IEC 60079-0:2017</li><li>• EN IEC 60079-0:2018</li><li>• BS EN IEC 60079-0:2018</li><li>• IEC 60079-11:2011</li><li>• EN 60079-11:2012</li><li>• BS EN 60079-11:2012</li></ul>



### WARNING

- Do not disassemble or modify the product.
- Do not replace the dry battery in a hazardous area.
- Use only a Toshiba AA alkaline battery (LR6) or Duracell AA alkaline battery (MN1500).



## Product code

INST. No. 00 0 0 0 0 0 0 0 0 0  
          A B C       D    E

- A: Year of manufacture (0 to 9)
- B: Month of manufacture (1 to 9 for January to September, X for October, Y for November, Z for December)
- C: Manufacturing lot
- D: Serial number
- E: Factory code

### <Japanese explosion-proof specifications>

<b>Explosion-proof construction</b>	Intrinsically safe explosion-proof construction
<b>Explosion-proof class</b>	Ex ia IIC T4 Ga
<b>Ambient temperature</b>	-20°C to +50°C
<b>Rating</b>	Power supply: 1.5 V DC (Toshiba LR6 battery ×1)
<b>Certificate number</b>	RP-3R : DEK18.0040 RP-3R(Pro) : DEK18.0041 RP-3R(S) : DEK20.0030 RP-3R(Pro/S) : DEK20.0031
<b>Applicable standards</b>	JNIOSH-TR-46-1: 2015 JNIOSH-TR-46-6: 2015
<b>Enclosure protection class</b>	IP20 Protection against human access: finger Protection against hazardous water ingress: no protection



## **WARNING**

- Check to confirm that the product model indicated on the nameplate is correct. The nameplate also includes the following information:
  - Product model: RP-3R/RP-3R (Pro)/RP-3R (S)/RP-3R (Pro/S)
  - Manufacturer: Riken Keiki Co., Ltd.
  - Explosion-proof class: Ex ia IIC T4 Ga
  - Ambient temperature: -20°C to +50°C
  - Battery type: Toshiba LR6
  - Warning: Do not remove the battery in hazardous locations.
- To ensure required explosion-proof performance, the RP-3R and RP-3R (S) must be connected to the explosion-proof electrical equipment type certified GX-3R. The RP-3R (Pro) and RP-3R (Pro/S) must be connected to the explosion-proof electrical equipment type certified GX-3R Pro.



## **RIKEN KEIKI Co., Ltd.**

**2-7-6 Azusawa, Itabashi-ku, Tokyo, 174-8744, Japan**

**Phone: +81-3-3966-1113**

**Fax: +81-3-3558-9110**

**E-mail: [intdept@rikenkeiki.co.jp](mailto:intdept@rikenkeiki.co.jp)**

**Website: <https://www.rikenkeiki.co.jp>**

# Product Configuration

## 3-1. Main unit and standard accessories

Open the box and packaging and inspect the product and accessories.  
If anything is missing, contact Riken Keiki.

### Main unit

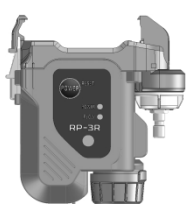

RP-3R



RP-3R (Pro)

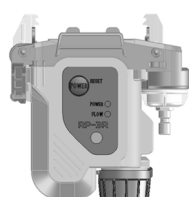

RP-3R (S)

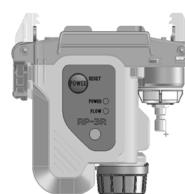

RP-3R (Pro/S)

### Standard accessories

AA alkaline battery (Toshiba LR6): ×1



Tapered nozzle: ×1



## 3-2. Part names and functions

### 3-2-1. RP-3R or RP-3R (Pro)

\* This illustration depicts the RP-3R (Pro).

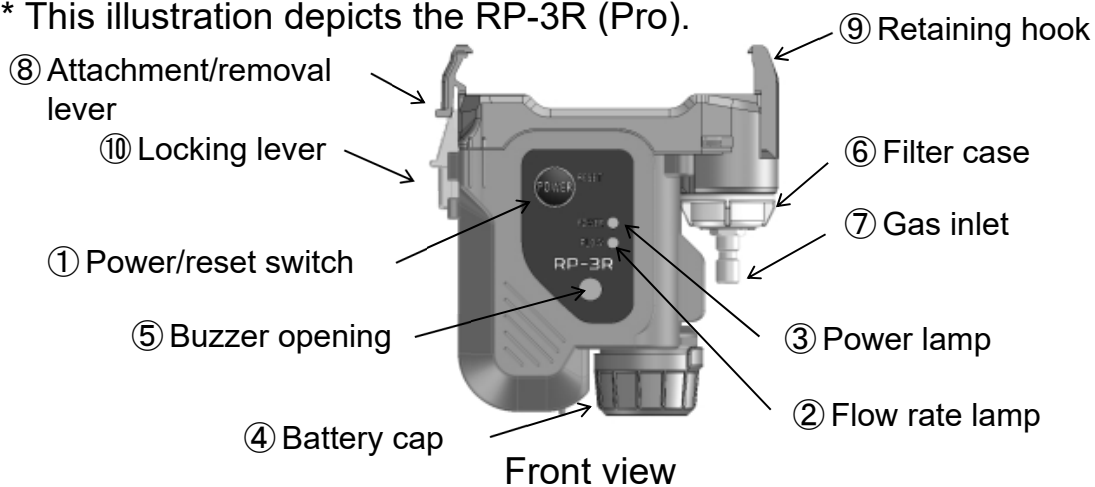

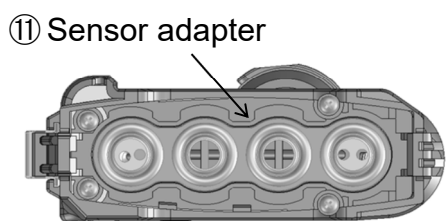

Top view

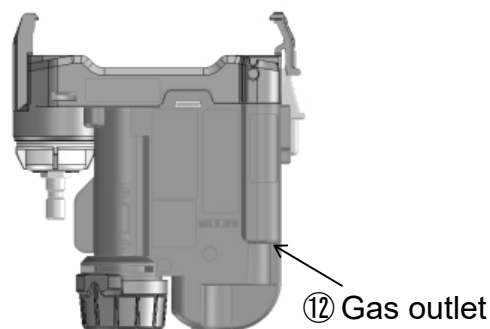

Rear view

①	<b>Power/reset switch (POWER/RESET)</b>	Turns the power on and off. Used to reset the low flow rate alarm
②	<b>Flow rate lamp (FLOW)</b>	Steady illumination (yellow) in High mode Flashing (yellow) in Low mode Flashing rapidly (yellow) when a low flow rate alarm is issued
③	<b>Power lamp (POWER)</b>	Steady illumination (green) when the power is on Flashing (green) when the battery level is low
④	<b>Battery cap</b>	Cap for the battery compartment
⑤	<b>Buzzer opening</b>	Opening from which the buzzer sounds
⑥	<b>Filter case</b>	Contains filters. Remove to replace the filters. Open only to replace the filters.
⑦	<b>Gas inlet</b>	Gas inlet
⑧	<b>Attachment/removal lever</b>	Used to attach or remove the GX-3R or GX-3R Pro to or from the product
⑨	<b>Retaining hook</b>	Used to attach or remove the GX-3R or GX-3R Pro to or from the product
⑩	<b>Locking lever</b>	Used to secure the GX-3R or GX-3R Pro to the product
⑪	<b>Sensor adapter</b>	Used to connect the GX-3R or GX-3R Pro sensor unit
⑫	<b>Gas outlet</b>	Gas outlet



**CAUTION**

- Avoid prodding the buzzer opening with sharp objects. Doing so may result in damage or failure.
- Do not remove the panel sheet from the indication panel.

## 3-2-2. RP-3R (S) or RP-3R (Pro/S)

\* This illustration depicts the RP-3R (Pro/S).

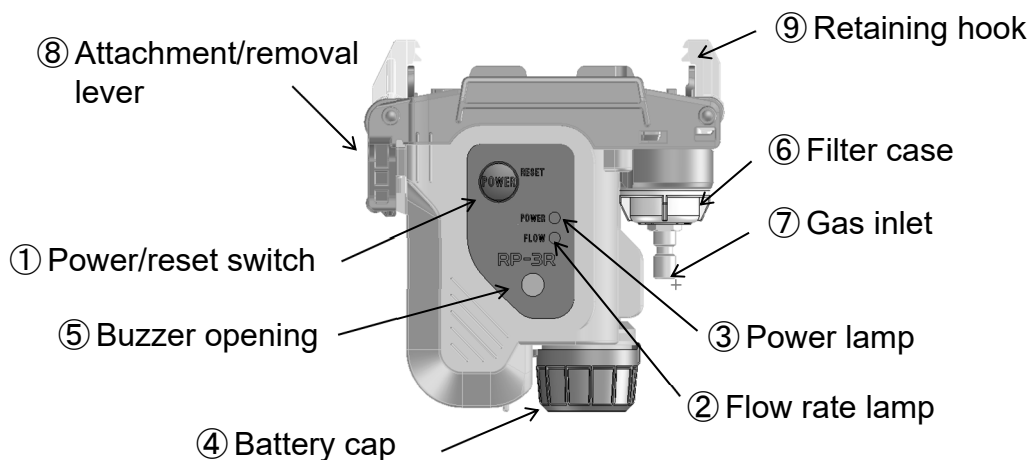

Front view

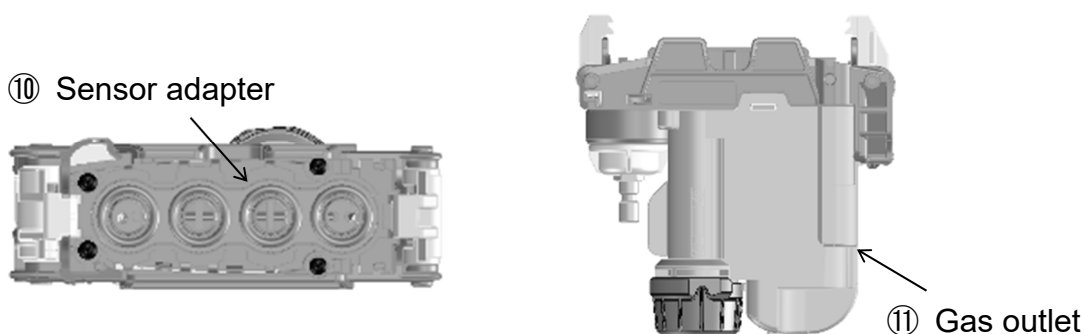

Top view

Rear view

①	<b>Power/reset switch (POWER/RESET)</b>	Turns the power on and off. Used to reset the low flow rate alarm
②	<b>Flow rate lamp (FLOW)</b>	Steady illumination (yellow) in High mode Flashing (yellow) in Low mode Flashing rapidly (yellow) when a low flow rate alarm is issued
③	<b>Power lamp (POWER)</b>	Steady illumination (green) when the power is on Flashing (green) when the battery level is low
④	<b>Battery cap</b>	Cap for the battery compartment
⑤	<b>Buzzer opening</b>	Opening from which the buzzer sounds
⑥	<b>Filter case</b>	Contains filters. Remove to replace the filters. Open only to replace the filters.
⑦	<b>Gas inlet</b>	Gas inlet

⑧	<b>Attachment/ removal lever</b>	Used to attach or remove the GX-3R or GX-3R Pro to or from the product
⑨	<b>Retaining hook</b>	Used to attach or remove the GX-3R or GX-3R Pro to or from the product
⑩	<b>Sensor adapter</b>	Used to connect the GX-3R or GX-3R Pro sensor unit
⑪	<b>Gas outlet</b>	Gas outlet



### **CAUTION**

- Avoid prodding the buzzer opening with sharp objects. Doing so may result in damage or failure.
- Do not remove the panel sheet from the indication panel.

# Usage Procedures

## 4-1. Usage note

The operating precautions apply to both users who have previously used the product and first-time users. Failure to observe these precautions may result in failure of the product and/or inability to detect gas correctly.

## 4-2. Preparations for startup

Observe the following precautions before starting gas detection. Otherwise, the product cannot be used correctly.

- Check to confirm that the battery level is sufficient.
- Check to confirm that the filters are not dirty.
- Cover the gas inlet with the product power turned on. Confirm that a low flow rate alarm occurs within five seconds. If no alarm occurs, check to confirm that the product is attached correctly to the GX-3R or GX-3R Pro.
- Attach the tapered nozzle to the gas inlet of the product.

## 4-3. Battery insertion and replacement

When using the product for the first time or if the battery level is low, insert a new AA alkaline battery.



### CAUTION

#### Battery replacement

- Always turn off the power for the product before replacing the battery.
- Replace the battery only in nonhazardous locations.
- Always replace with a new battery.
- Note the polarity when inserting a new battery.
- The battery may fall out if the battery cap is not properly secured (tightened).

#### Battery

- Do not use rechargeable batteries.



## CAUTION

- Use the following battery types:

<Japanese explosion-proof specifications>

To ensure explosion-proof performance, use an AA alkaline battery (Toshiba LR6) indicated on the certificate of conformity for electrical equipment used in potentially explosive atmospheres.

<ATEX/IECEX specifications>

Use only a Toshiba AA alkaline battery (LR6) or Duracell AA alkaline battery (MN1500).

- ① Push the battery cap in and rotate to the position indicated in the following diagram to remove.

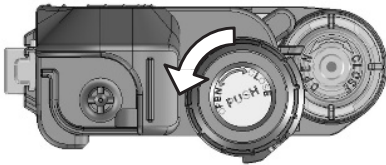

- ② Insert a new battery. Note the polarity.

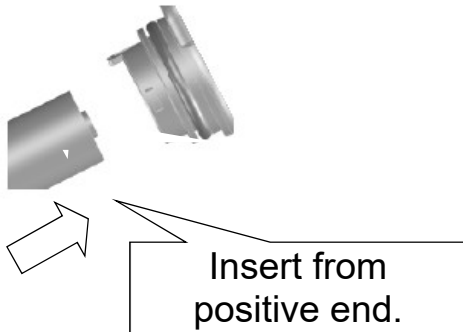

- ③ Push the battery cap in and rotate to the position indicated in the following diagram.

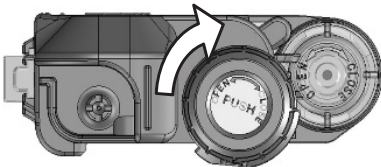



## 4-4. Attaching the GX-3R or GX-3R Pro

### 4-4-1. RP-3R or RP-3R (Pro)

Attach the GX-3R or GX-3R Pro for the RP-3R or RP-3R (Pro) as described here. The illustration in the procedure here depicts the RP-3R (Pro).

#### NOTE

Check to confirm beforehand that the locations where the product makes contact with the GX-3R or GX-3R Pro (e.g., grooves and clips) are free of dirt, foreign material, and scratches. Also check to confirm that the rubber seal on the product is not distorted. The product may not be able to be used correctly if the rubber seal is distorted. Contact Riken Keiki to request replacement of the rubber seal.

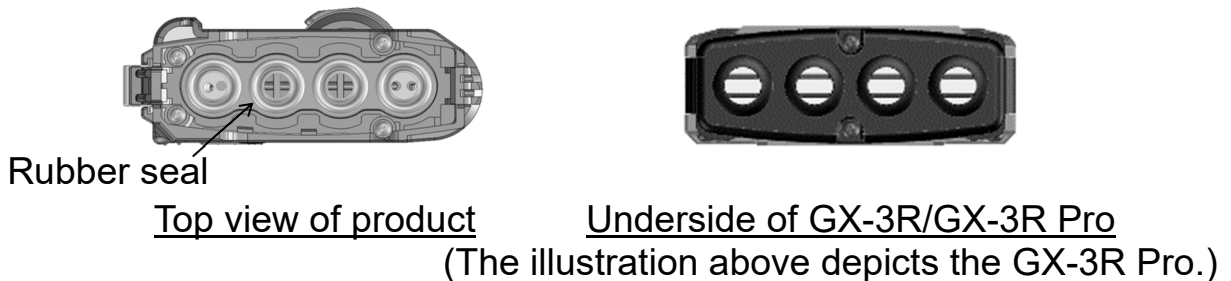

- ① Push down the locking lever.

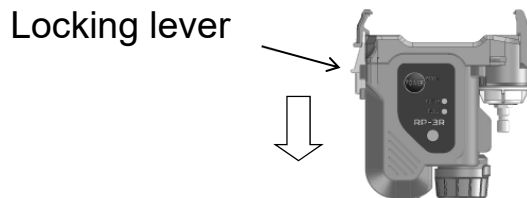

- ② Attach the GX-3R or GX-3R Pro to the product.

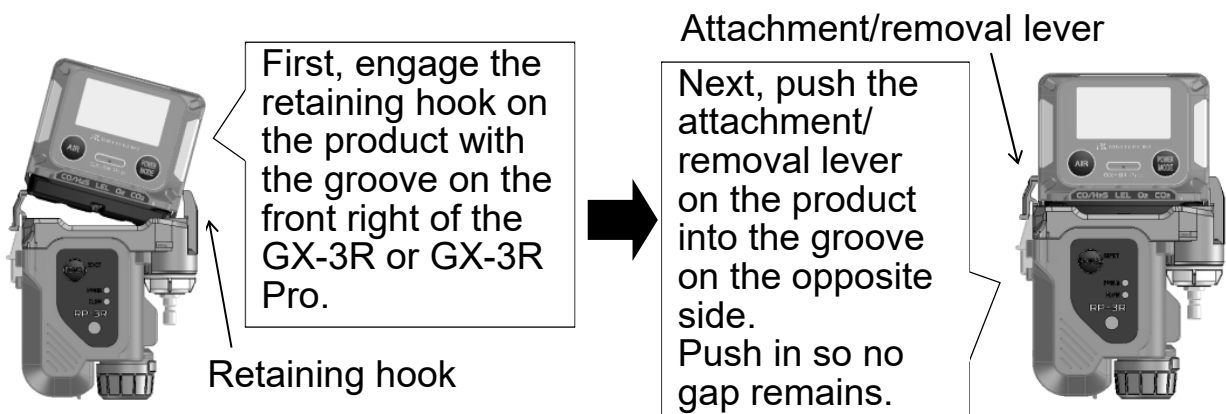

## NOTE

Make sure the GX-3R/GX-3R Pro does not scrape against the rubber seal on the product during attachment.

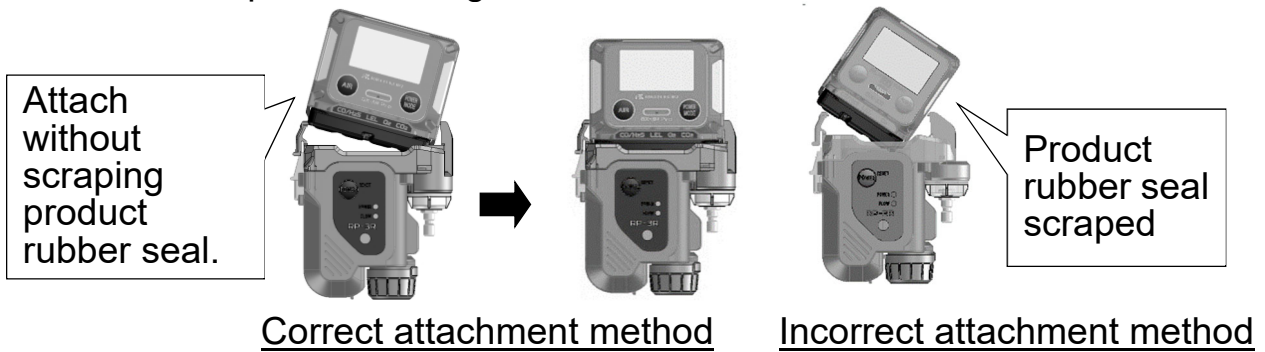

- ③ Check to confirm that the locking lever lifts up and the attachment/removal lever and retaining hook are secure.

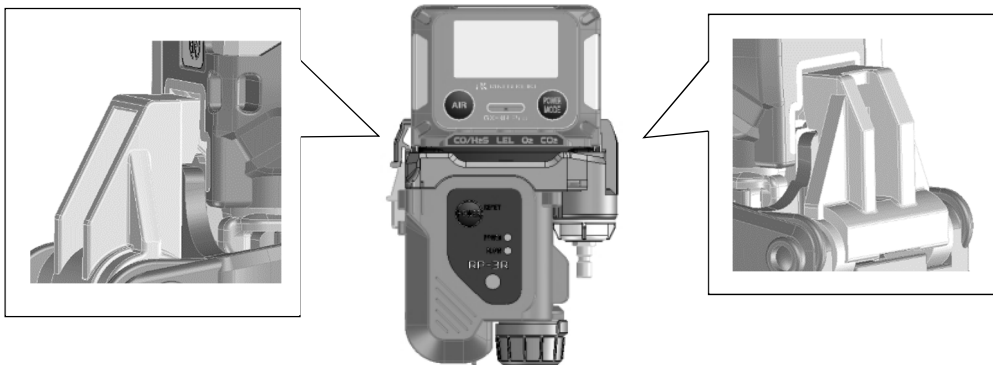

## 4-4-2. RP-3R (S) or RP-3R (Pro/S)

Attach the GX-3R or GX-3R Pro for the RP-3R (S) or RP-3R (Pro/S) as described here. The illustration in the procedure here depicts the RP-3R (Pro/S).

### NOTE

Check to confirm beforehand that the locations where the product makes contact with the GX-3R or GX-3R Pro (e.g., grooves and clips) are free of dirt, foreign material, and scratches. Also check to confirm that the rubber seal on the product is not distorted. The product may not be able to be used correctly if the rubber seal is distorted. Contact Riken Keiki to request replacement of the rubber seal.

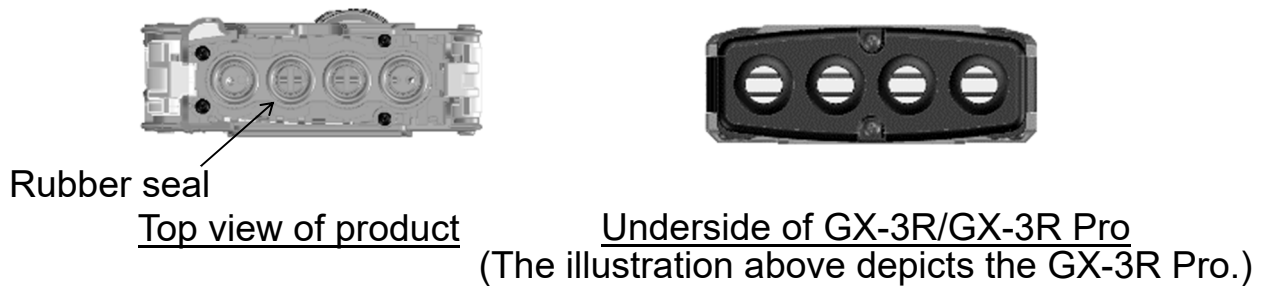

- ① Press the part marked “PUSH” on the attachment/removal lever on the side of the product.

Attachment/  
removal lever

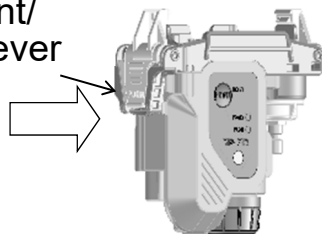

- ② While pressing the attachment/removal lever, attach the GX-3R or GX-3R Pro from directly above the product.

Attach  
from  
directly  
above.

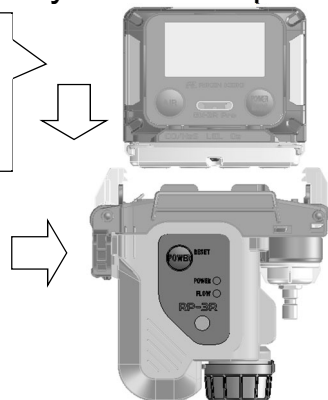

Push in so  
no gap  
remains.

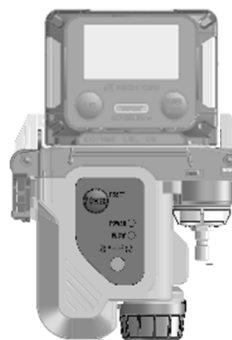

## NOTE

Make sure the GX-3R/GX-3R Pro does not scrape against the rubber seal on the product during attachment.

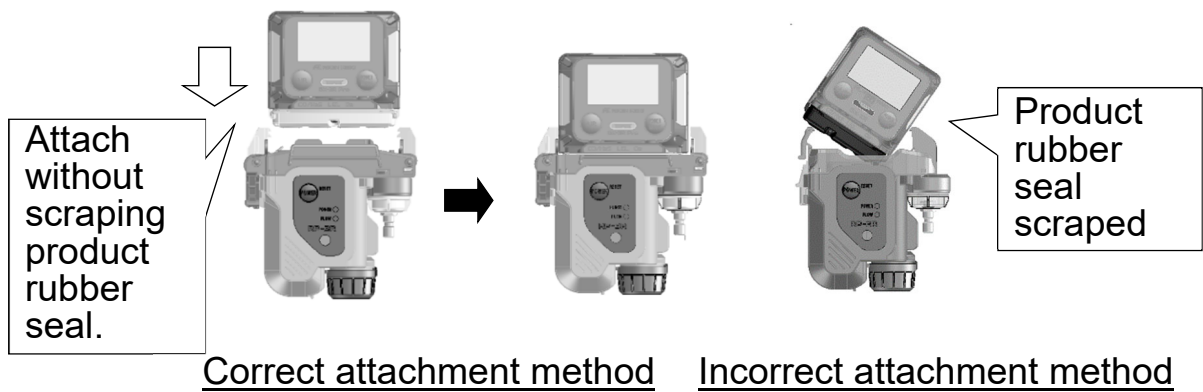

- ③ Check to confirm that the attachment/removal lever and retaining hook are secure.

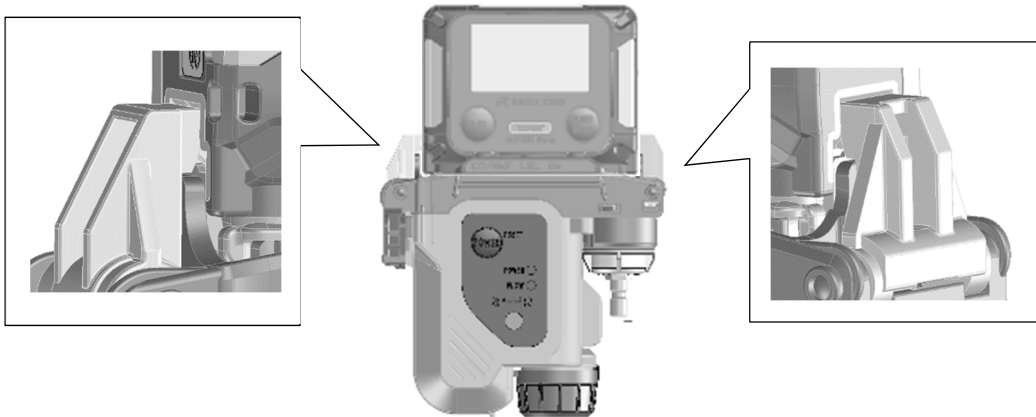

## 4-5. Removing the GX-3R or GX-3R Pro

### 4-5-1. RP-3R or RP-3R (Pro)

- ① Push down the locking lever on the product and the attachment/removal lever at the same time.

Attachment/  
removal lever  
Locking lever

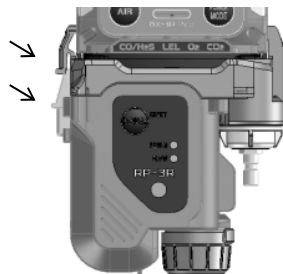

- ② Remove the GX-3R or GX-3R Pro from the product.



### 4-5-2. RP-3R (S) or RP-3R (Pro/S)

- ① Press the part marked "PUSH" on the attachment/removal lever on the side of the product.

Attachment/  
removal lever

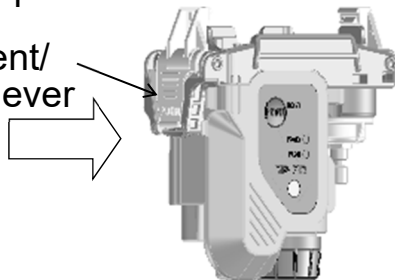

- ② Remove the GX-3R or GX-3R Pro from the product while pressing on the attachment/removal lever.



## 4-6. Startup and shutdown procedures

### Turning on the power

Press and hold the power switch (POWER/RESET) for approximately one second until the power lamp (POWER) illuminates in green and you hear a short beep.

#### NOTE

- Release the switch once the power lamp (POWER) illuminates and the product beeps.
- Use in cold conditions will reduce battery performance and operating times.
- You may hear an intermittent driving sound when starting up the pump in cold conditions. This is normal and does not indicate a malfunction.
- Check to confirm that the pipes are not blocked before turning on the power. Low flow rates cannot be detected for approximately 10 seconds after starting the pump in cold conditions.
- Once the product power is turned on, cover the gas inlet, and confirm that the low flow rate alarm occurs within five seconds before starting use. If no alarm occurs, check to confirm that the rubber seal on the product sensor adapter is not deformed and that the product is attached correctly to the GX-3R/GX-3R Pro.

### Turning off the power

Press and hold the power switch (POWER/RESET) for approximately three seconds until the power lamp (POWER) goes out and you hear a long beep. Release the switch once the product beeps.

## 4-7. Switching pump suction flow rates

This product lets you set the pump suction flow rate to High mode (approximately 500 mL/min) or Low mode (approximately 350 mL/min). The suction flow rate is indicated by the flow rate lamp (FLOW).

- Flow rate lamp (FLOW) steadily illuminates in yellow: High mode
- Flow rate lamp (FLOW) flashes in yellow: Low mode

### Suction flow rate Low mode

Press and hold the power switch (POWER/RESET) for approximately one second until the flow rate lamp (FLOW) begins flashing in yellow. Release the switch once the flow rate lamp (FLOW) begins flashing in yellow.

## Suction flow rate High mode

Press and hold the power switch (POWER/RESET) for approximately one second until the flow rate lamp (FLOW) illuminates steadily in yellow. Release the switch once the flow rate lamp (FLOW) illuminates steadily in yellow.

### NOTE

- In cold conditions (-10°C or below), suction flow rate Low mode automatically switches to suction flow rate High mode.
- In cold conditions (-10°C or below), suction flow rate High mode cannot be switched to suction flow rate Low mode.

## 4-8. Fault alarms

### Low flow rate alarm

Issues an alarm on detecting low suction flow rate. 《Self-latching operation》

<Indications>

**Alarm lamp**

Low flow rate alarm lamp (LOW FLOW) flashes rapidly in yellow.

**Buzzer**

Buzzer sounds intermittently.

<Alarm resetting procedure>

Check the filters and replace if dirty. After eliminating the cause of the alarm, press the power switch (POWER/RESET) to reset the alarm.

### Low battery voltage alarm

Issues an alarm on detecting low battery voltage. 《Auto reset operation》

<Indications>

**Alarm lamp**

Power lamp (POWER) flashes in green.

<Alarm resetting procedure>

Turn off the power and eliminate the cause of the alarm, such as by replacing with a new battery in a nonhazardous location.

# Maintenance

The product is an important safety and disaster prevention device. Maintain the product at regular intervals to ensure performance and improve disaster-prevention and safety reliability.

## 5-1. Maintenance intervals and items

- Daily maintenance: Perform maintenance before commencing work.
- Monthly maintenance: Perform maintenance by testing the alarms once a month.
- Regular maintenance: Perform maintenance at least once a year (ideally, at least once every six months).

Maintenance item	Maintenance details	Daily maintenance	Monthly maintenance	Regular maintenance
Battery level check	Check to confirm adequate battery power.	○	○	○
Filter check	Check to confirm that the filters are not dirty or clogged.	○	○	○

### <Maintenance service>

- Riken Keiki provides services related to regular maintenance, adjustment, and servicing.
- The main items of the maintenance service are as follows. For more information, contact Riken Keiki.

### Major service details

- Filter check : Checking that the filters are not dirty or clogged.  
Replacement if dirty or clogged
- Alarm test : Confirming that the alarm lamps and buzzer function correctly
- Product cleaning and repair (visual inspection) : Checking the product exterior for dirt and cleaning/repairing visible areas. Replacing parts if cracked or damaged
- Product operation check : Checking switch operations and individual functions
- Consumable parts replacement : Replacing filters and other consumable parts



## 5-2. Cleaning procedure

The product must be cleaned if it becomes too dirty. Turn off the power and wipe off any dirt with a cloth. Do not use water or organic solvents to clean the product. Doing so may cause malfunctions.



### CAUTION

- Do not use water or organic solvents such as alcohol or benzene when wiping the product. These substances may discolor or damage the surface of the product.
- Do not use high-pressure air to clean the product. Doing so may cause malfunctions.

## 5-3. Filter replacement

- ① Rotate the filter case 90 degrees counterclockwise to remove from the main unit.
- ② The product has two filters (primary and secondary filters) sandwiching a metal mesh. Turn the main unit upside down and allow the filters to drop out onto your hand. The filters detach from the main unit. If the filters do not readily come off, remove with tweezers and replace.

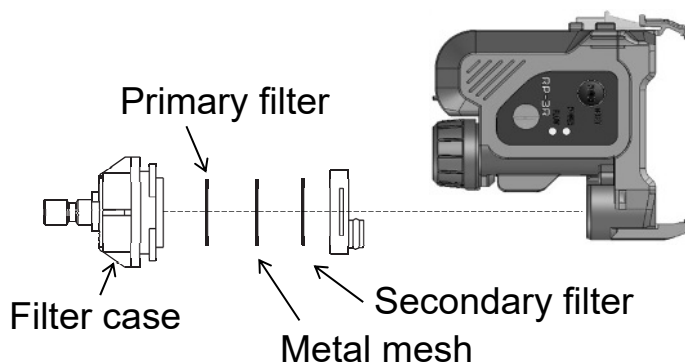

### CAUTION

- Leakage may occur if not properly tightened, resulting in incorrect gas measurements. The same will occur if microscopic foreign matter is trapped between filters.

## 5-4. Periodic replacement parts list

Name	Check interval	Replace-ment interval	Quantity (per unit)	Remarks
AA alkaline battery	-	-	1	Part No.: 2753 3007 80
Filter	3 months	6 months	2	Part No.: 4181 9573 10 (set of 10)
Metal mesh	-	-	1	Part No.: 4181 9574 90 (set of 10)
Pump	6 months	1 to 2 years	1	*
Rubber seals	-	3 to 6 years	1 set	*

\* A functional check by a qualified service engineer is required after replacement. To ensure safety and the stable operation of the product, request checking by a qualified service engineer. Contact Riken Keiki to request checking.

### NOTE

The above replacement intervals are guidelines only. Replacement intervals may vary depending on actual operating conditions. These intervals do not constitute warranty periods. The replacement timing may vary depending on the results of daily and regular maintenance.

# Storage and Disposal

## 6-1. Procedures for storage or when not in use for extended periods

The product must be stored in the following environment:

- ① In a dark place at normal temperature and humidity and away from direct sunlight
- ② In a place free of gases, solvents, and vapor

Store the product in the original product packaging box, if available. If the box is no longer available, store the product away from dust, etc.



### CAUTION

- If you do not intend to use the product for extended periods, store with the battery removed. Battery leaks may result in fire or injury.
- Even if you do not intend to use the product for extended periods, turn the power on at least once every six months to check pump suction (by running the product for approximately three minutes). Grease inside the pump motor may solidify and prevent operation if the product is not operated for extended periods.

## 6-2. Procedure for reuse

Contact Riken Keiki before resuming use of the product after extended storage.

## 6-3. Product disposal

Dispose of the product as industrial waste (incombustible) in accordance with local regulations.

<Disposal in EU member states>

When disposing of the product in an EU member state, dispose of the battery separately.

The battery removed from the battery compartment must be handled in accordance with waste sorting and collection or recycling systems stipulated by the regulations of EU member states.

---

## NOTE

### **Crossed-out recycle dustbin mark**

This pictogram is affixed to products which contain batteries that fall under EU Battery Directive 2006/66/EC. Such batteries need to be disposed of as specified by the latest directive. This pictogram indicates that the batteries need to be separated from ordinary waste and disposed of appropriately.

---



# Troubleshooting

This troubleshooting section does not cover the causes of all problems that may occur with the product. It provides brief explanations to assist in determining the causes of common problems. If you encounter symptoms not addressed here or if problems persist even after taking corrective action, contact Riken Keiki.

Symptoms	Cause	Action
The power cannot be turned on.	The battery is depleted.	Replace with a new battery in a nonhazardous location.
	The POWER/RESET switch was not held down long enough.	Press and hold the POWER/RESET switch for approximately one second until you hear a short beep.
Abnormal operation	Effects of sudden surge noise	Turn off the power and restart.
The switch does not work.	Effects of sudden surge noise	Remove the battery in a nonhazardous location, reinsert, then restart the product.
Low battery voltage alarm indication	The battery level is low.	Turn off the power and replace with a new battery in a nonhazardous location.
Low flow rate alarm indication	Water or oil is aspirated into the interior.	Check the filters and replace if dirty.
	The filters or tapered nozzle is clogged.	<ul style="list-style-type: none"> <li>• Check the filters and replace if dirty.</li> <li>• Check to confirm that the filter case is fitted correctly. If not, fit correctly.</li> <li>• Check the tapered nozzle for clogging. Remove any clogs.</li> </ul>
	The pump is deteriorated.	Contact Riken Keiki to request pump replacement.

# Product Specifications

Model	RP-3R	RP-3R (Pro)	RP-3R (S)	RP-3R (Pro/S)
<b>Suction flow rate</b>	High mode: Approximately 500 mL/min Low mode: Approximately 350 mL/min			
<b>Alarm indications</b>	<Low flow rate alarm>		FLOW lamp rapid flashing (yellow)	
	<Low battery voltage alarm>		POWER lamp flashing (green)	
<b>Power supply</b>	AA alkaline battery ×1 Explosion-proof electrical equipment type certified specifications: Toshiba LR6 ATEX/IECEX specifications: Toshiba LR6 or Duracell MN1500			
<b>Continuous operating time</b>	High mode: Approximately 10 hours Low mode: Approximately 16 hours (at 25°C, with no alarms and a new battery)			
<b>Operating temperature range</b>	-20°C to +50°C (no sudden changes)			
<b>Operating humidity range</b>	Up to 95% RH (no condensation)			
<b>External dimensions</b> (Main unit only)	Approximately 82 (W) × 96 (H) × 29 (D) mm		Approximately 93 (W) × 95 (H) × 29 (D) mm	Approximately 94 (W) × 95 (H) × 29 (D) mm
<b>Weight</b>	Approximately 120 g		Approximately 130 g	
<b>Explosion-proof</b>	Intrinsically safe explosion-proof construction Explosion-proof electrical equipment type certified Ex ia IIC T4 Ga (-20 to +50°C, Toshiba LR6) ATEX/UKEX II1G Ex ia IIC T4 Ga (-20°C to +50°C, Toshiba LR6) II1G Ex ia IIC T4 Ga (-20°C to +40°C, Duracell MN1500) II1G Ex ia IIC T3 Ga (-20°C to +50°C, Duracell MN1500) IECEX Ex ia IIC T4 Ga (-20°C to +50°C, Toshiba LR6) Ex ia IIC T4 Ga (-20°C to +40°C, Duracell MN1500) Ex ia IIC T3 Ga (-20°C to +50°C, Duracell MN1500)			
<b>Standard accessories</b>	AA alkaline battery ×1, tapered nozzle			
<b>Options</b> (Available separately)	Float-type gas collector, filters (set of 10), metal meshes (set of 10)			

## Revision history

Issue	Revision	Issue date
0	First issue	2019/3/18
1	NOTE added in 4-7	2019/3/20
2	1-4 and 2-4 added, 4-2 and 5-1 corrected, NOTE added in 4-4 and 4-6	2019/7/29
3	Declaration of Conformity	2019/11/26
4	Declaration of Conformity	2020/4/1
5	RP-3R(S) and RP-3R(Pro/S) added Declaration of Conformity	2020/8/5
6	Type approval number added, Declaration of Conformity	2020/10/30
7	NOTE added in 4-6, 5-4 corrected	2021/5/10
8	Declaration of Conformity	2021/10/29
9	Safety information, Declaration of Conformity	2022/11/24



# EU-Declaration of Conformity

Document No.: 320CE22076



We, RIKEN KEIKI Co., Ltd. 2-7-6, Azusawa, Itabashi-ku, Tokyo, 174-8744 Japan declare under our sole responsibility that the following product conforms to all the relevant provisions.

Product Name: Gas Suction Pump Unit  
Model: RP-3R, RP-3R (Pro), RP-3R (S), RP-3R (Pro/S)  
RP-3R (G)

Council Directives		Applicable Standards
2014/30/EU	EMC Directive	EN 50270:2015
2014/34/EU	ATEX Directive	EN IEC 60079-0:2018 EN 60079-11:2012
2011/65/EU <sup>[1]</sup>	RoHS Directive	EN IEC 63000:2018

<sup>[1]</sup>Including substances added by Commission Delegated Directive (EU) 2015/863

EU-Type examination Certificate No. Presafe 17 ATEX 11584

Notified Body for ATEX DNV Product Assurance AS (NB 2460)  
Veritasveien 1  
1363 Høvik  
Norway

Auditing Organization for ATEX DNV Product Assurance AS (NB 2460)  
Veritasveien 1  
1363 Høvik  
Norway

The marking of the product shall include the following:

 II 1 G Ex ia IIC T4 Ga -20°C≤Ta≤+50°C(use w/LR6 battery)  
 II 1 G Ex ia IIC T4 Ga -20°C≤Ta≤+40°C(use w/MN1500 battery)  
 II 1 G Ex ia IIC T3 Ga -20°C≤Ta≤+50°C(use w/ MN1500 battery)

Place: Tokyo, Japan

Date: Jun. 29, 2022

Takakura Toshiyuki  
General manager  
Quality Control Center





# UK-Declaration of Conformity

Document No.: 320UK22042



We, RIKEN KEIKI Co., Ltd. 2-7-6, Azusawa, Itabashi-ku, Tokyo, 174-8744, Japan declare under our sole responsibility that the following product conforms to all the relevant provisions.

Product Name: Gas Suction Pump Unit  
Model: RP-3R, RP-3R (Pro), RP-3R (S), RP-3R (Pro/S), RP-3R (G)

Regulations	UK designated Standards
Electromagnetic Compatibility Regulations 2016 (S.I. 2016/1091)	BS EN 50270:2015
The Equipment and Protective Systems Intended for Use in Potentially Explosive Atmospheres Regulations 2016 (S.I. 2016/1107) (UKEX)	BS EN IEC 60079-0:2018 BS EN 60079-11:2012
The Restriction of the Use of Certain Hazardous Substances in Electrical and Electronic Equipment Regulations 2012 (S.I. 2012/3032)	BS EN IEC 63000:2018

UK-Type examination Certificate No. DNV 22 UKEX 25921

Approved Body for UKEX DNV Business Assurance UK Ltd (AB8501)  
4th Floor Vivo Building, 30 Stamford Street,  
London SE1 9LQ, United Kingdom

Auditing Organization for UKEX DNV Business Assurance UK Ltd (AB8501)  
4th Floor Vivo Building, 30 Stamford Street,  
London SE1 9LQ, United Kingdom

The marking of the product shall include the following:

 II 1 G Ex ia IIC T4 Ga -20°C≤Ta≤+50°C(use w/LR6 battery)  
 II 1 G Ex ia IIC T4 Ga -20°C≤Ta≤+40°C(use w/MN1500 battery)  
 II 1 G Ex ia IIC T3 Ga -20°C≤Ta≤+50°C(use w/MN1500 battery)

Place: Tokyo, Japan

Date: Nov. 18, 2022

Takakura Toshiyuki  
General manager  
Quality Control Center