



Smart transmitter/Gas Detector Head

SD-3

Safety Manual

Document Number: PT2E-306(Rev.12)

[NOTE] The SD-3 is certified for functional safety (IEC 61508:2010 Part 2 and Part 3).
To ensure certified functionality, maintain the product as described in this document.

RIKEN KEIKI Co., Ltd.

2-7-6 Azusawa, Itabashi-ku, Tokyo, 174-8744, Japan









Phone : +81-3-3966-1113



Fax : +81-3-3558-9110

E-mail : intdept@rikenkeiki.co.jp

Web site : <https://www.rikenkeiki.co.jp/>

Revision history

Rev.	Details	Approved	Checked	Created
0	New document	KOGURE Shinsuke	MUTOU Hiroki	SAIKI Yuki
		Jun 25, 2021	Jun 25, 2021	Jun 25, 2021
1	Only rev up to match the Japanese version	KOGURE Shinsuke	MUTOU Hiroki	SAIKI Yuki
		Jun 25,2021	Jun 25,2021	Jun 25,2021
2	Add SD-3EC 	KOGURE Shinsuke	MUTOU Hiroki	SAIKI Yuki
		Nov 16,2021	Nov 16,2021	Nov 16,2021
3	P8 2-4 Change Diagnosis response 15s -> 20s. P11 2-15 Product service life. Chang to the sensor and Oter than the Sensor 	KOGURE Shinsuke	MUTOU Hiroki	SAIKI Yuki
		Dec 2,2021	Dec 2,2021	Dec 2,2021
4	P8 2-6 Proof test Add wording P11 2-11 Reliability data update P12 2-19 H/W,S/W version update 	KOGURE Shinsuke	MUTOU Hiroki	SAIKI Yuki
		Jun 28,2022	Jun 28,2022	Jun 28,2022
5	P4 Change wording 1-1 Ambient conditions P5 Add 1-3 Applicable standards P6 Add Table 2 Environmental condition P9 Add item in 2-3 Safety accuracy P12 Update 2-11 Reliability data P13 Add item 2-19 H/W S/W version 	KOGURE Shinsuke	MUTOU Hiroki	SAIKI Yuki
		Jan 10,2023	Jan 10,2023	Jan 10,2023
6	P12 Update 2-11 Reliability data P13 Delete item and Version UP 2-19 H/W S/W version 	KOGURE Shinsuke	HIRAO Keisuke	SAIKI Yuki
		Apr 27,2023	Apr 27,2023	Apr 27,2023
7	P12 Update 2-11 Reliability data 	KOGURE Shinsuke	HIRAO Keisuke	SAIKI Yuki
		May 17,2023	May 17,2023	May 17,2023
8	P7 Change to Table2.Environmental condition P13 Update 2-11 Reliability data P14 Update 2-19 H/W S/W version 	KOGURE Shinsuke	HIRAO Keisuke	SAIKI Yuki
		Aug 4,2023	Aug 4,2023	Aug 4,2023
9	Change from "operating manual" to "SD-3 Series Export Specifications Technical Manual for SIL and FM Specifications (PT2E-287) rev.7"  Update 2-19 Identification of hardware/software configurations Update 2-11 Reliability data	KOGURE Shinsuke	HIRAO Keisuke	SAIKI Yuki
		Aug 10,2023	Aug 10,2023	Aug 10,2023

10	Update note of Table2		KOGURE Shinsuke	HIRAO Keisuke	SAIKI Yuki
			Aug 16,2023	Aug 16,2023	Aug 16,2023
11	Update 1-1 Ambient conditions		KOGURE Shinsuke	HIRAO Keisuke	SAIKI Yuki
			Aug 17,2023	Aug 17,2023	Aug 17,2023
12	Update 1-1 Ambient conditions Update 2-19 Identification of hardware/software configurations		KOGURE Shinsuke	HIRAO Keisuke	SAIKI Yuki
			Aug 21,2023	Aug 21,2023	Aug 21,2023

Contents

1	Purpose.....	5
1-1	Ambient conditions.....	5
1-2	Regulations and applicable standards (functional safety).....	5
1-3	Applicable standards (other than functional safety standards)	6
1-4	Magnetic field threshold limit values (immunity level)	7
2	Usage Instructions.....	9
2-1	Safety Functions.....	9
2-2	Non-functional safety features.....	9
2-3	Safety accuracy	11
2-4	Diagnosis response	11
2-5	Setup.....	11
2-6	Proof test	11
2-7	Maintenance	13
2-8	Repairs and replacements.....	13
2-9	Storage, Relocation, and Disposal	13
2-10	Startup time (initialization time)	13
2-11	Reliability data.....	14
2-12	Operation mode	14
2-13	Availability rate.....	14
2-14	Power source.....	14
2-15	Product service life	14
2-16	Requested parameter settings	14
2-17	Limitations on installation and operating environments	15
2-18	Application limitations	15
2-19	Identification of hardware/software configurations.....	15
2-20	Product Specifications	15
2-21	Error codes and message	15
2-22	Operator interfaces.....	15
2-23	Prohibited items.....	16
2-24	Terminology and abbreviations.....	16

Safety Manual

1 Purpose



This Safety Manual can be used at SIL2 in HFT 0 and SIL 3 in HFT 1. (SIL 3 Capable)
This document discusses topics for which the user is responsible if the SD-3 (this product), a certified device, functions as or is part of a configuration functioning as a safety instrument. These topics include proof testing, repairs and replacement, reliability data, product service life, environmental limitations, operational limitations, and various parameters. To ensure product safety, carefully read this document and all related documents.

This product monitors combustible gases, toxic gases, and oxygen concentrations at sampling points.

This safety device is designed to prevent gas-related accidents and injury by outputting a current (4 - 20 mA) to indicate the gas concentrations detected.

Classified as a sensor (subsystem) for safety devices, this product outputs 4 - 20 mA current according to the gas concentrations detected, or HART protocol signals when requested by the upstream system, to a logic section of the upstream system.

This product was developed for use as a single sensor in a SIL2 loop (IEC 61508).

- 1-1 Ambient conditions  
- | | | |
|------------------------------------|-------------------------------------|---|
| Operating temperature range | : -40 to +70 °C (no sudden changes) | |
| Absolute Maximum temperature range | : -45 to +75 °C (no sudden changes) |  |
| Operating humidity range | : 10 to 90 %RH (no condensation) | |
| Storage temperature range | : -10 to +40 °C (no sudden changes) | |
| Storage humidity range | : 10 to 90 %RH (no condensation) | |
- See Table 2. for SD-3EC and SD-3ECB
- 1-2 Regulations and applicable standards (functional safety)
IEC 61508:2010 Parts 1 to 7
Functional Safety of Electrical/Electronic/Programmable Electronic
Safety-Related Systems





1-3 Applicable standards (other than functional safety standards)

	Japanese explosion-proof	General provisions in 2015 technological standards Flameproof enclosures in technological standard 2018
△5	EMC related	EN 50270:2015 (Type 2) BS EN 50270:2015 (Type 2)
	IECEx standards	IEC 60079-0:2017 IEC 60079-1:2014
△5	ATEX related	EN IEC 60079-0:2018 EN 60079-1:2014 BS EN IEC 60079-0:2018 BS EN 60079-1:2014
	Performance related	IEC/EN 60079-29-1 EN 45544-3 EN 50104
	HART	HART7

1-4 Magnetic field threshold limit values (immunity level)
EN 50270:2015 request level

Table 1 Immunity test requirements: EN 50270:2015 (Type 2)

Item	Test Procedure	Specification	Criteria
Electrostatic discharges	EN 61000-4-2:2009	±6 kV (CD: contact discharge) ±8 kV (AD: air discharge)	A
Radio-frequency electromagnetic field	EN 61000-4-3:2006 +A1:2008 +A2:2010	10 V/m: 80 – 1,000 MHz 10 V/m: 1.4 - 2 GHz 3 V/m: 2 - 2.7 GHz 80 %AM, 1 kHz (unmodulated, rms)	A
Electrical fast transient/burst (DC power) (Earth line) (I/O signal)	EN 61000-4-4:2004 +A1:2010	(DC power, earth line) ±2 kV (5/50 ns, 5 kHz) (I/O Signal) ±1 kV (5/50 ns, 5 kHz)	A
Surges (DC power) (I/O signal)	EN 61000-4-5:2006	(DC power) ±2 kV (line to ground) ±1 kV (line to line) (1.2/50 (8/20) µs) (I/O signal) ±1 kV (line to ground) (1.2/50 (8/20) µs)	B
Radio-frequency common mode (I/O signal)	EN 61000-4-6:2009	0.15 - 80 MHz, 10 V (unmodulated, rms) 80 %AM, 1 kHz	A
Power frequency magnetic field	EN 61000-4-8:2010	50/60 Hz, 30 A/m (rms)	A
Voltage dips	EN61000-4-29	0 % residual voltage / 1,000 ms duration 40 % residual voltage / 1,000 ms duration	C
Short interruptions	EN61000-4-29	0 % residual voltage / 20 ms duration	C

Table2. Environmental condition     

Model	Gas type	Operating temperature range ※1	Absolute Maximum temperature range※1	Operating humidity range ※1	storage conditions ※1	note
ESF-A24P	CO	-25~55°C	-30~60°C	20~90%RH	-10°C~+40°C 0%RH~ 90%RH	-
ESF-A24R	H2S	-25~55°C	-30~60°C	20~90%RH	-10°C~+40°C 0%RH~ 90%RH	-
ESF-B22	NH3	-25~55°C	-30~60°C	30~80%RH	-10°C~+40°C 0%RH~ 90%RH	-
ESF-A24A	NO2	-25~55°C	-30~60°C	20~90%RH	-10°C~+40°C 0%RH~ 90%RH	-
ESF-X24P2	O2	-25~55°C	-30~60°C	20~90%RH	-10°C~+40°C 0%RH~ 90%RH	-
ESF-C92	CL2	-20~55°C	-25~60°C	30~80%RH	-10°C~+40°C 0%RH~ 90%RH	-

※1 No sudden changes in temperature or condensation (no fluctuations of 10°C or more per hour).

If the temperature fluctuates more than 10°C or more per hour, please use optional accessories.

2 Usage Instructions

2-1 Safety Functions

The following items are the safety functions of this product.

- Monitors combustible gases, toxic gases, and oxygen concentrations at sampling points.
- Safe status means the current is output to the upstream system according to the concentrations of the combustible gases, toxic gases, or oxygen being monitored. The product outputs 4 - 20 mA signals and HART protocol signals (*).
- 4 - 20 mA output

The relationship between the measured gas concentrations and 4 - 20 mA output is proportional. The output is 4 mA at F.S ×0 %, and when concentration is full scale, the output is 20mA at F.S×100 %.

* HART output is not included in the safety functions.

2-2 Non-functional safety features

The following features are not functional safety features:

- HART output
- Contact output (optional)
- RS485 output (optional)

System example

An example of a system that controls a solenoid valve via PLCs to create a shut off.

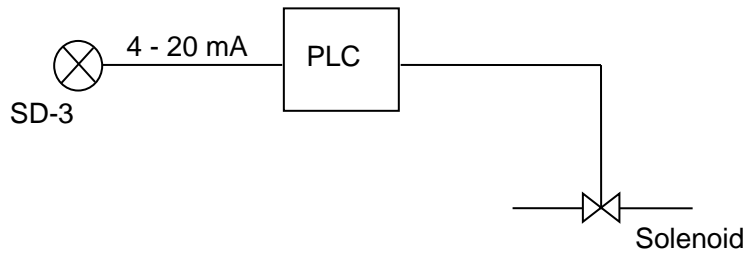

<SD-3>

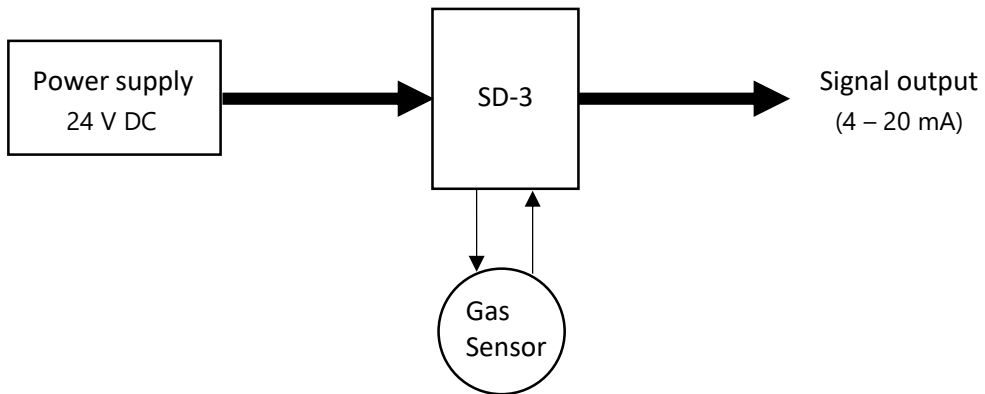

<SD-3SC+GD-3>

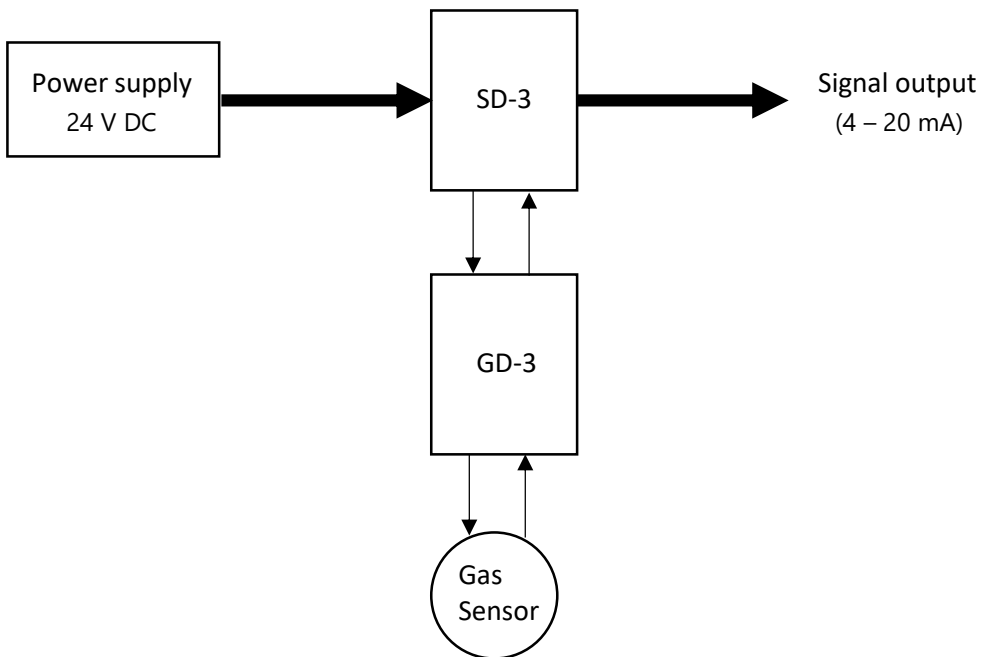

2-3 Safety accuracy

Safety accuracy: 20 %

*The FMEDA failure rate includes failures of internal parts causing deviations exceeding this accuracy.

Applicable sensors: NCF series

Gas response: 50 % of response time is within 20 seconds

90 % of response time is within 60 seconds

Applicable sensors: IRF series

Gas response: 50 % of response time is within 20 seconds

90 % of response time is within 60 seconds



Applicable sensors: ESF(Toxic) series

Gas response: 50 % of response time is within 60 seconds

90 % of response time is within 150 seconds



Applicable sensors: ESF(O2) series

Gas response: 20 % of response time is within 10 seconds

90 % of response time is within 45 seconds

2-4 Diagnosis response

ROM/RAM check self-diagnostic: 24 hours

Maximum response time for self-diagnostic results other than the above: 20 seconds

*This indicates that notification is output within this time with regard to part failures detected by the self-diagnostic.s. Note that this is the combined total time for the self-diagnostic test interval and failure response time.

2-5 Setup

Refer to '5.Usage Instruction' in the "SD-3 Series Export Specifications Technical Manual for SIL and FM Specifications (PT2E-287) rev.7". Also test the parameters already set.



2-6 Proof test

Proof test details: Calibration, adjustment of 4 - 20 mA output values, sensor replacement, etc.



Do not replace the sensor by yourself.
 (Refer to '7-7-2 Replacement of periodic replacement parts' in the
 "SD-3Series Export Specifications Technical Manual for SIL and FM
 Specifications (PT2E-287) rev.7" for the frequency for replacing
 sensors.) 

Proof test standards: Must allow/perform calibration.
 Alarm delay times and gas response times must meet performance
 expectations.

MTTR: 24 hours

Tools used: Refer below

Tools used	Specifications	Maintenance
Calibration gas	Depends on gas type.	Must be traceable.
Calibration adapter	Dedicated calibration adapter for IRF sensors (4283 9011 00) Dedicated calibration adapter for combustible F sensors (4283 9012 70)  Dedicated calibration adapter for ESF sensors (4283 9013 40)	Undamaged
Pump	One with flow rate of 0.5 L/min or more One meeting explosion-proof specifications	Maintenance by the manufacturer
Flowmeter	One capable of measuring to 0.1 L tolerances One with markings allowing identification of flow rate settings and tolerances It is also possible to adjust the flow rate with a pump equipped with a flowmeter	Maintenance by the manufacturer
Piping	For general combustible gases – Material: Polyurethane Internal diameter: 4 mm Pipe length: Within 1 m For organic solvent gases – Material: Teflon Internal diameter: 4 mm Pipe length: Within 1 m For strongly adsorptive gases – Material: Teflon Internal diameter: 4 mm Pipe length: Within 10 cm	Undamaged

Proof test procedure

- 1) Bypass the safety function and take appropriate action to avoid a false trip.
- 2) Use HART communications to retrieve any diagnostics and take appropriate action.
- 3) Send a HART command to the gas detector to go to the high alarm current output and verify that the analog current reaches that value.*1
- 4) Send a HART command to the gas detector to go to the low alarm current output and verify that the analog current reaches that value.*2
- 5) Inspect the gas detector for any leaks, visible damage, or contamination.
- 6) Perform a two-point calibration of the gas detector over the full working range.
- 7) Remove the bypass and otherwise restore normal operation

*1 This tests for compliance voltage problems such as a low loop power supply voltage or increased wiring resistance. This also tests for other possible failures.

*2 This tests for possible quiescent current related failures.

* Functionality anticipates disabling of product functions when performing the proof test.

* Keep a record of proof test results.

(Refer to the “SD-3 Series Export Specifications Technical Manual for SIL and FM Specifications (PT2E-287) rev.7” for more information.) 

*This product may malfunction if the proof test is not performed correctly. The proof test must be performed by trained service personnel.

2-7 Maintenance

For maintenance items other than the proof test, refer to ‘7. Maintenance’ in the “SD-3 Series Export Specifications Technical Manual for SIL and FM Specifications (PT2E-287) rev.7”. 

2-8 Repairs and replacements

Refer to ‘7-7 Parts replacement’ in the “SD-3 Series Export Specifications Technical Manual for SIL and FM Specifications (PT2E-287) rev.7”. 

2-9 Storage, Relocation, and Disposal

Refer to ‘8. Storage, Relocation, and Disposal’ in the “SD-3 Series Export Specifications Technical Manual for SIL and FM Specifications (PT2E-287) rev.7”. 





2-10 Startup time (initialization time)

Refer to ‘5.Usage Instruction’ in the “SD-3 Series Export Specifications Technical Manual for SIL and FM Specifications (PT2E-287) rev.7”. 

2-11 Reliability data

Failure rates, failure modes, and other information are recorded in the following FMEDA report.

<H/W Version 2.1 or earlier>

	Model	FMEDA report Report No.:
	SD-3EC	RK 21/04-192 R003 V3R3   

<H/W Version 2.2 or later> 

Model	FMEDA report Report No.:
SD-3RI	RK 19/01-130 R001 V3R5
SD-3NC	RK 20/05-036 R002 V2R5
SD-3EC	RK 21/04-192 R003 V3R4
SD-3ECB	RK 22/05-277 R004 V1R5

Refer to the separate 'FMEDA Report'.

To satisfy SIL2, use at HFT = 0. To satisfy SIL3, use at HFT = 1.

2-12 Operation mode

Low frequency operation request mode (frequency of operation requests is once annually or less)

2-13 Availability rate

Availability rate: Constantly available

2-14 Power source

Rating: 24 V DC

Allowable range: 18.0 to 30.0 V DC

2-15 Product service life

Product service life: 10 years (Other than the sensor).

3 years (sensor)



The reliability data in the FMEDA report is valid only during this period.

2-16 Requested parameter settings

- The 4 - 20 mA output value in the event of a use involving burnout (failure) is 3.6 mA or less or 21 mA or greater.
- From a security perspective, use a write protect function that prevents changes in settings via HART protocol signals.

- The above requirements must be met for applications involving functional safety.

2-17 Limitations on installation and operating environments







Installation: Refer to '4. Installation' in the "SD-3 Series Export Specifications Technical Manual for SIL and FM Specifications (PT2E-287) rev.7". 

Operating environment: Refer to '10. Product Specifications' in the "SD-3 Series Export Specifications Technical Manual for SIL and FM Specifications (PT2E-287) rev.7". 

2-18 Application limitations

Refer to '5.Usage Instruction' in the "SD-3 Series Export Specifications Technical Manual for SIL and FM Specifications (PT2E-287) rev.7". 

2-19 Identification of hardware/software configurations





SD-3EC(H2S):			
Software Version	Ver 2.1		
Hardware Version	Ver 2.1		

SD-3RI

SD-3NC

SD-3EC(H2S,CO,O2)

SD-3ECB(CL2,NH3,NO2)

Software Version	Ver 2.2		
Hardware Version	Ver 2.2		

2-20 Product Specifications

Refer to '10. Product Specifications' in the "SD-3 Series Export Specifications Technical Manual for SIL and FM Specifications (PT2E-287) rev.7". 

2-21 Error codes and message

Corrective action and procedures when faults or errors occur

Refer to '9.Troubleshooting' in the "SD-3 Series Export Specifications Technical Manual for SIL and FM Specifications (PT2E-287) rev.7". 

2-22 Operator interfaces

Refer to '5.Usage Instruction' in the "SD-3 Series Export Specifications Technical Manual for SIL and FM Specifications (PT2E-287) rev.7". 

2-23 Prohibited items

Modification of this product is prohibited.

2-24 Terminology and abbreviations

Term

Safety	Freedom from unacceptable risk of harm.
Functional Safety	The ability of a system to carry out the actions necessary to achieve or to maintain a defined safe state for the equipment under control of system
Basic Safety	The equipment must be designed and manufactured such that it protects against resulting fire and explosion under explosive atmosphere
Safety Assessment	The investigation to arrive at a judgment - based on evidence - of the safety achieved by safety-related systems
Fail-Safe State	State that the defined fail-safe
Fail Safe	Failure that go to the defined fail-safe state without a demand from the process
Fail Dangerous	Failure that does not respond to a demand from the process (i.e. being unable to go to the defined fail-safe state). Failure that deviates the process signal or the actual output by more than 15% of span, drifts away from the user defined threshold (Trip Point) and that leaves the output within active scale.
Fail Dangerous Undetected	Failure that is dangerous and that is not being diagnosed by automatic stroke testing.
Fail Dangerous Detected	Failure that is dangerous but is detected by automatic stroke testing.
Fail Annunciation Undetected	Failure that does not cause a false trip or prevent the safety function but does cause loss of an automatic diagnostic and is not detected by another diagnostic.
Fail Annunciation Detected	Failure that does not cause a false trip or prevent the safety function but does cause loss of an automatic diagnostic or false diagnostic indication.
Fail No Effect	Failure of a component that is part of the safety function but that has no effect on the safety function.
Low demand mode	Mode, where the frequency of demands for operation made on a safety-related system is no greater than twice the proof test frequency.

Abbreviations

FMEDA	<u>Failure Modes, Effects and Diagnostic Analysis</u>
HFT	<u>Hardware Fault Tolerance</u> Tolerance that to keep executing the function requested under the hardware fault and error condition
MOC	<u>Management of Change</u> Management of change the hardware or software elements, and keep traceability
PFDavg	<u>Average Probability of Failure on Demand</u>
SFF	<u>Safe Failure Fraction</u> The fraction of the overall failure rate of a device that results in either a safe fault or a diagnosed unsafe fault.
SIF	<u>Safety Instrumented Function</u> A set of equipment intended to reduce the risk due to a specific hazard.
SIL	<u>Safety Integrity Level</u> Discrete level (one out of a possible four) for specifying the safety integrity requirements of the safety functions to be allocated to the E/E/PE safety-related systems where Safety Integrity Level 4 has the highest level of safety integrity and Safety Integrity Level 1 has the lowest.
SIS	<u>Safety Instrumented System</u> Implementation of one or more Safety Instrumented Functions. A SIS is composed of any combination of sensor(s), logic solver(s), and final element(s).