



PT2E-2658

Indoor Carbon Dioxide Monitor

RI-600

Operating Manual

RIKEN KEIKI Co., Ltd.

2-7-6 Azusawa, Itabashi-ku, Tokyo, 174-8744, Japan

Phone : +81-3-3966-1113

Fax : +81-3-3558-9110

E-mail : intdept@rikenkeiki.co.jp

Web site : <https://www.rikenkeiki.co.jp/english/>

Contents

1. Outline of the Product.....	3
Preface.....	3
Purpose of use.....	3
Definition of DANGER, WARNING, CAUTION and NOTE	4
Method of confirmation for CE/UKCA marking type	4
2. Important Notices on Safety.....	5
2-1. Danger cases.....	5
2-2. Warning cases	6
2-3. Precautions.....	6
3. Product Components.....	7
3-1. Main unit and standard accessories.....	7
3-2. Names and functions for each part	9
4. How to Install	11
4-1. Precautions for installation points	11
4-2. Precautions for system designing	12
4-3. Installation of main unit.....	14
4-4. Precautions for wiring	16
5. How to Use	19
5-1. Before using the monitor	19
5-2. Preparation for start-up	19
5-3. Basic operating procedures.....	20
5-4. Power-on	21
5-5. Modes	22
5-6. User mode	23
5-7. Power-off	25
6. Alarm Activation and Functions	26
6-1. Gas alarm activation.....	26
6-2. Fault alarm activation	27
6-3. External output operation	27
7. Maintenance	28
7-1. Maintenance intervals and items.....	28
7-2. Maintenance (regular maintenance) mode	29
8. Storage and Disposal	44
8-1. Procedures to store the monitor or leave it for a long time.....	44
8-2. Procedures to relocate the monitor or use it again	44
8-3. Disposal of products	44
9. Troubleshooting.....	45
10. Product Specifications.....	47
10-1. List of specifications	47
11. Appendix	48
11-1. Detection principle of Non-Dispersive Infrared Ray	48
11-2. Definition of terms.....	48

1

Outline of the Product

Preface

Thank you for choosing our indoor carbon dioxide monitor RI-600 (hereinafter referred to as the monitor). Please check that the model number of the product you purchased is included in the specifications on this manual.

This manual describes how to use the monitor properly and its specifications. Not only the first-time users but also the users who have already used the monitor must read and understand the operating manual and use this product as described in this manual.

Note that the contents of this manual are subject to change without notice for product improvement. It is also prohibited to copy or reproduce this manual, in whole or in part, without permission.

Regardless of warranty period, we shall not make any indemnification for accidents and damage caused by using the monitor.

Make sure to read the warranty policy specified on the warranty.



Purpose of use

This carbon dioxide monitor measures carbon dioxide in the air. While displaying measured carbon dioxide concentration on the LCD, the monitor converts it to an analog signal of 4 - 20 mA to output and outputs a gas contact to ventilate the room at a gas alarm state which carbon dioxide concentration rises over preset concentration (alarm setpoint).

The monitor is a safety unit, not an analyzer which performs quantitative/qualitative analysis/measurement for gas. Check the specifications before use and conduct measurement properly in accordance with purposes.

Definition of DANGER, WARNING, CAUTION and NOTE

Throughout this manual, the following indications are used to ensure safe and effective work.

 DANGER	This message indicates that improper handling may cause serious damage on life, health or assets.
 WARNING	This message indicates that improper handling may cause serious damage on health or assets.
 CAUTION	This message indicates that improper handling may cause minor damage on health or assets.
NOTE	This message indicates advice on handling.

Method of confirmation for CE/UKCA marking type

The CE/UKCA marking is labeled on the detector in case of comply with CE/UKCA mark. Please confirm the instrument specification before using. Please refer Declaration of Conformity that is at the end of this manual if you have CE/UKCA marking type.

You can confirm instrument specification to see the CE/UKCA mark as follows.

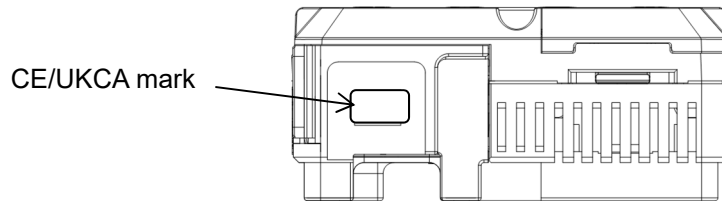

CE/UKCA mark label (Bottom of instrument)
(DC specification only)

2

Important Notices on Safety

To maintain the performance of the monitor and use it safely, observe the following instructions with WARNING and CAUTION.

**WARNING**

- If an abnormality is found in the monitor, contact RIKEN KEIKI immediately. Visit our Web site to find your nearest RIKEN KEIKI office.
Web site: <https://www.rikenkeiki.co.jp/>

2-1. Danger cases

**DANGER**

- This is not an explosion-proof unit. Never attempt to measure a gas in an atmosphere over the lower explosive limit.

2-2. Warning cases



WARNING

- Before turning on the monitor, always check that the voltage is compliant with the specifications. Operating on an unstable power supply may cause malfunctions.
- Do not operate this monitor in a place where combustible/explosive gases or vapors are present. Operating the monitor in such an environment will lead to extreme dangers.
- Perform span adjustment at fixed intervals.
- Do not run the power cable and remote sensor cable of the monitor in parallel with cables of high-frequency or high-voltage and other device's power cables. It may cause malfunctions.
- If a cable of high-frequency or high-voltage and the power cable need to intersect with each other, it should be orthogonally connected.
- When wiring, be careful not to apply any stresses on the cables by pulling, tightening or twisting, etc.
- Do not disassemble/modify the monitor. It may invalidate the warranty of the performance. Changing the settings without understanding them may cause alarm malfunctions. Please use the monitor properly in accordance with the operating manual.
- Do not use the monitor with it attached to a control device, equipment, etc.

2-3. Precautions



CAUTION

- Do not use a device, such as a transceiver, which transmits a radio wave near the monitor or its cables. It may affect the measurement. If a transceiver or other radio wave transmitting device is used, it must be used in a place away from the monitor where it disturbs nothing.
- Restarting the monitor within five seconds after turning it off may cause errors.
- This is not a control unit. It is not allowed to use the external output of the monitor to control other units.
- This is a safety unit. Never fail to perform a regular maintenance to ensure safety. Continuing to use the monitor without performing maintenance will compromise the sensitivity of the sensor, thus resulting in inaccurate gas detection.
- Do not pick the sensor or buzzer opening with a sharp-pointed item. The unit may cause malfunction or get damaged, possibly resulting in incorrect measurements.
- Do not let the monitor draw in water. Do not also install the monitor in a place where the monitor may get wet. Ignoring this may cause malfunction because the monitor is not water- and drip-proof.
- This is a precision device. Do not give strong shock or vibration to the monitor.
- When the case is opened for wiring or other operation, do not touch inner parts. When wiring, be sure that excessive pressure is not applied to the power cable and remote sensor cable.
- Do not block the vent for the sensor.

3

Product Components

3-1. Main unit and standard accessories

After opening the carton box, check the monitor and accessories.
If there is anything missing, contact RIKEN KEIKI.

Main unit

For names and functions of individual parts of the monitor and LCD display, see "3-2. Names and functions for each part" (P.9).

RI-600 main unit

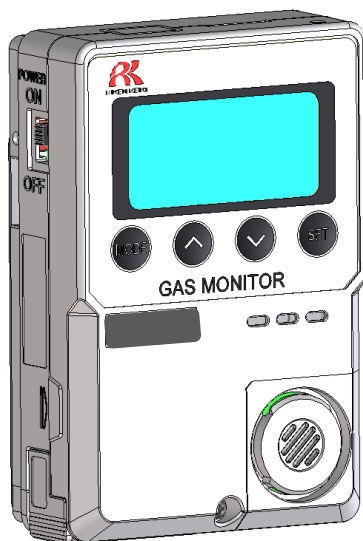

Sensor unit (Remote type)

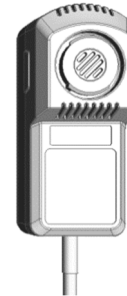

NOTE

- Which type to use - sensor integrated type or sensor unit supplied type (remote type) - can be ordered at the time of purchase.
 - The sensor integrated type does not include the sensor unit (remote type).
 - The cable length for the remote type can be selected from 3, 5, 10 and 20 m.
 - The remote type can be selected only 0-2vol%/0-5vol%.
-

Standard accessories

- Cross-recessed pan head machine screw (2 pcs.)
- Cross-recessed round head wood screw (2 pcs.)
- 3.2 m AC power cable (1 pc.) *Supplied only with AC specification
- Operating manual (1 pc.)



CAUTION

- The main unit and sensor unit (remote type) are precision devices. Be careful not to drop the monitor when installing or uninstalling the main unit or sensor unit. Dropping the monitor may compromise its original performance or cause malfunctions.

Optional accessories

- Installation board (1 pc.)
- Gas calibration cap (1 pc.)

Outline drawing

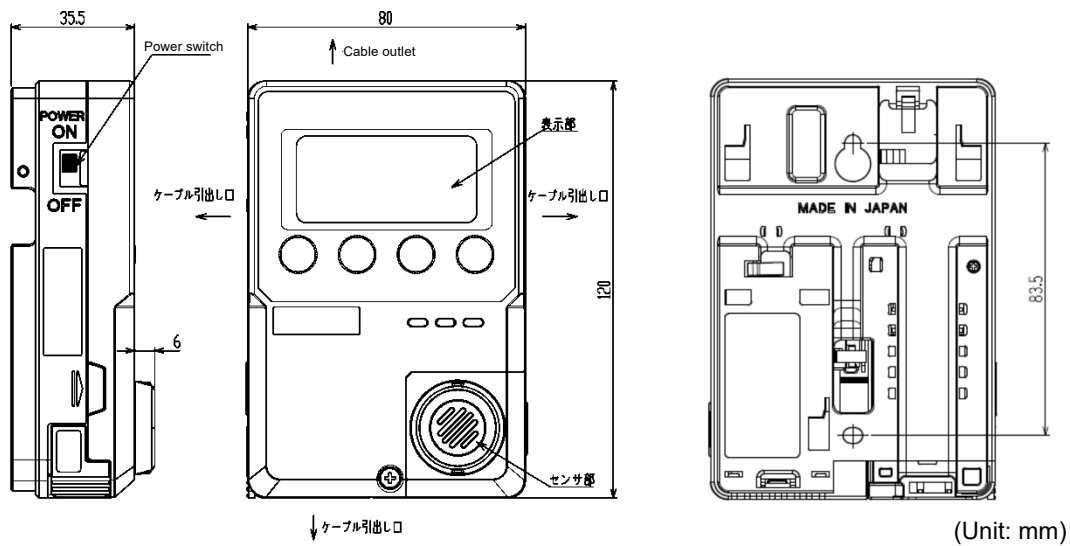

Main unit

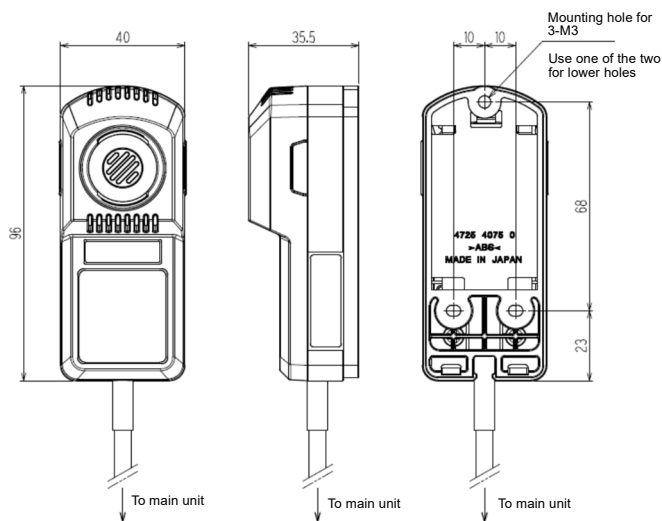

Remote sensor

3-2. Names and functions for each part

This section describes the names and functions of the individual parts and LCD display that make up the monitor.

Main unit

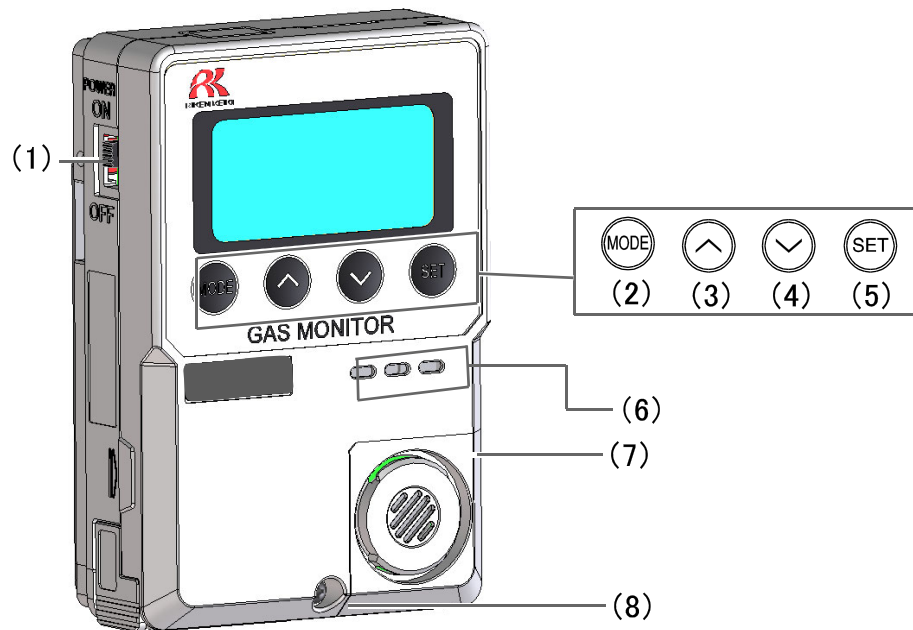

Name	Major function
(1) Power switch	Turns the power ON/OFF. Slide the switch up to power on and down to power off.
(2) MODE button	Hold down this button to enter the user mode. It is also used to cancel or skip during setup.
(3) ^ button	Used to change the screen and increase numerical values during setup.
(4) v button	Used to change the screen and decrease numerical values during setup.
(5) SET button	Used to confirm the setting.
(6) Buzzer sound opening	Emits operation and judgment sounds. (Do not block it.)
(7) Sensor part	Detects a gas to be detected. The sensor is inside the cover.
(8) Screw	Loosen this screw to open the case.

Display

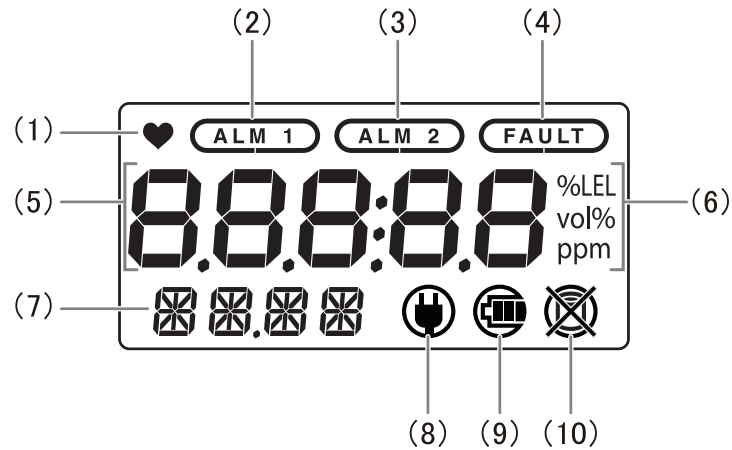

Name	Major function
(1) Operating state display	Displays the operating status. Blinks at a normal state.
(2) 1st alarm display	Lights up or flash in orange at a first alarm state.
(3) 2nd alarm display	Lights up or flash in red at a second alarm state.
(4) Fault alarm display	Lights up in red at a fault alarm state.
(5) Concentration value display Maintenance indicator	Displays the gas concentration. Maintenance items and others are displayed during setup.
(6) Unit display	Displays the unit (ppm/vol%) according to the specification.
(7) Gas name display Maintenance display	Displays the gas name. Maintenance items and others are displayed during setup.
(8) AC/DC power display	Lights up when the monitor is operating on AC or DC power.
(9) This is not used for the monitor.	
(10) This is not used for the monitor.	

4

How to Install

4-1. Precautions for installation points

When installing the monitor, never fail to observe the following precautions. Ignoring the precautions may damage the monitor, resulting in inaccurate gas detection.



CAUTION

- This is a precision device. Because the monitor may not provide the specified performance in some places (environments), check the environment in the installation site, and then take appropriate actions if necessary. Because the monitor plays an important role for safety and disaster prevention, it must be installed in appropriate points.
- Do not install this product in any of the following locations.
 - Place exposed to direct sunlight or outside
 - Place exposed to water
 - Place exposed to ventilation from an air conditioner, etc.
 - Place exposed to soot, smoke or steam
 - Place where the temperature drops below 0°C or rises over 40°C or the temperature changes suddenly
 - Place with high humidity like a bathroom
 - Place with bad ventilation such as behind a curtain or under the shadow.

<Do not install the monitor in a place with vibrations or shocks.>

The monitor consists of sensitive electronic parts. The monitor must be installed in a stable place without vibrations or shocks, etc. and it cannot drop.

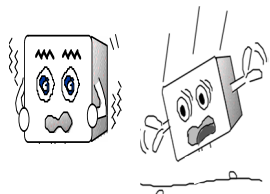

<Do not install the monitor in a place exposed to water, oil or chemicals, etc.>

When selecting installation points, avoid a place where the monitor is exposed to liquids such as water, oil, or chemicals.



<Do not install the monitor in a place where the temperature drops below 0°C or rises over 40°C.>

The operating temperature of the monitor is 0 to +40°C. Install the monitor in a stable place not exceeding the operating temperature range.

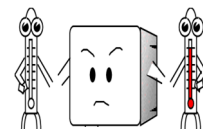

<Do not install the monitor in a place exposed to direct sunlight or sudden changes in the temperature.>

Avoid a place where the monitor is exposed to direct sunlight or radiant heat (infrared rays emitted from a high-temperature object), and where the unit temperature changes suddenly. Condensation may be formed inside the monitor, or the monitor cannot adjust to sudden changes in the temperature.

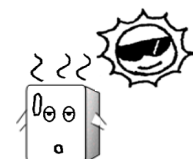

<Keep the monitor (and its cables) away from noise source devices.>

When selecting installation points, avoid a place where high-frequency/high-voltage devices exist.

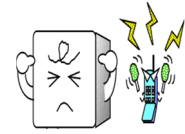

<Do not install the monitor in a place where maintenance of the monitor cannot be performed or where handling the monitor involves dangers.>

Regular maintenance of the monitor must be performed. Do not install the monitor in a place where the machinery must be stopped when maintenance is performed in its inside, where parts of the machinery must be removed to perform maintenance, or where the monitor cannot be removed because racks or other things prevent access to it. Do not install the monitor in a place where maintenance involves dangers, for example, near a high-voltage cable.

4-2. Precautions for system designing

Note the following precautions for system designing of the monitor.



CAUTION

- An unstable power supply and noise may cause malfunctions or false alarms.

Using a stable power supply

The external output and alarm contact of the monitor may be activated when the power is turned on, when momentary blackout occurs, or when the system is being stabilized. In such cases, use a UPS (uninterruptible power system), or take appropriate actions on the receiving side. The monitor must be provided with the following power supply.

Power supply voltage	100 - 120 VAC ±10% (50/60 Hz) or 24 VDC±10%
Allowed time of momentary blackout	Up to 10 milliseconds (To recover from the momentary blackout for 10 milliseconds or more, restart the monitor.) Example of actions To ensure continuous operation and activation, install a UPS (uninterruptible power system), etc. outside the monitor.
Others	Do not use it with a power supply of large power load or high-frequency noise. Example of actions Use a line filter, etc. to avoid the noise source if necessary.

Proper use of alarm contact

The alarm contact of the monitor is used to transmit signals to activate an air-conditioning control.



CAUTION

- The b contact (break contact) under de-energized state may be opened momentarily by a physical shock, such as external force.
When the b contact is selected for the alarm contact, take appropriate actions to prepare for a momentary activation, for example, add signal delay operation (approximately one second) to the receiving side of the b contact.

The specifications for the external output gas alarm contact of the monitor are based on the resistance load conditions. If inductive load is used at the alarm contact, the following errors will occur easily because counter electromotive force is generated at the contact.

- Deposition, defective insulation or defective contact at the relay contact
- Damage of any electric parts due to high-voltage generated inside the monitor
- Abnormal operations by an out-of-control CPU

If load is to be activated, appropriate measures must be taken to stabilize the operation of the monitor and protect the alarm contact referring to the following information.

- Relay it with an external relay at a lower voltage of 100 VAC or below (contact amplification). At the same time, the surge absorbing part SK1 suitable for the specifications must be attached to the external relay.
- In addition, the surge absorbing part SK2 must be attached to the loaded side of the external relay if necessary.
- It may be recommended that the surge absorbing part should be attached to the contact for certain load conditions. It must be attached to an appropriate position by checking how the load is activated.

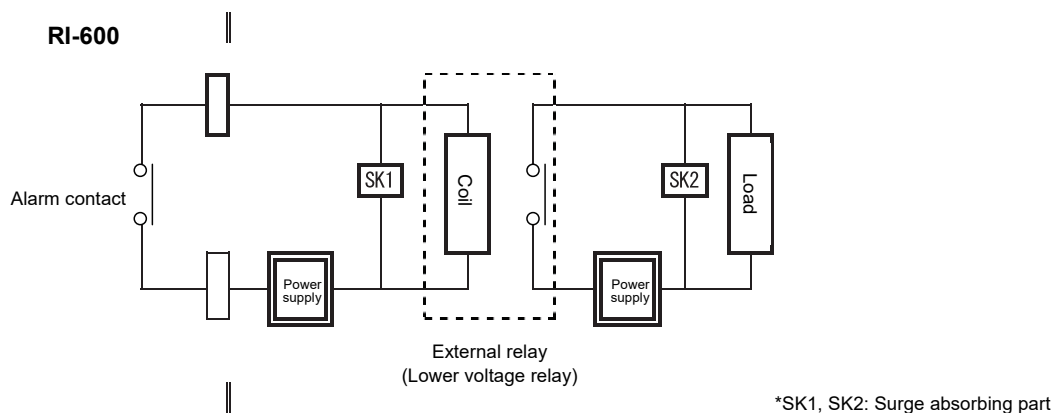

CAUTION

- In principle, do not activate inductive load at the alarm contact of the monitor. In particular, never use the inductive load to activate a fluorescent lamp or motor, etc.
- If inductive load is activated, relay it with an external relay (contact amplification). However, because the coil of an external relay also involves inductive load, select a relay at a lower voltage (100 VAC or below), and then protect the contact of the monitor with an appropriate surge absorbing part, such as a CR circuit.

4-3. Installation of main unit

Install the main unit on the wall 50 to 180 cm up from the floor.

If wall screws are available, remove the screw at the lower part of the main unit to open the cover and install the unit using the mounting holes on the back of the unit.



CAUTION

- Install the sensor in a place not directly exposed to ventilation from an air conditioner.
- Sudden changes in the temperature may cause the readings not to come back.



NOTE

- To install the main unit to the wall with screws, use the mounting holes on the back of the unit according to the following procedure.
 - (1) Loosen the screw at the lower part of the main unit and open the surface cover of the case.
 - (2) Push the both sides of the monitor until it clicked.
 - (3) Open the surface cover.
 - (4) Fix the main unit with two screws (M4) through the mounting holes.
 - (5) Put the surface cover back on the case and tighten the screw at the lower part of the main unit.

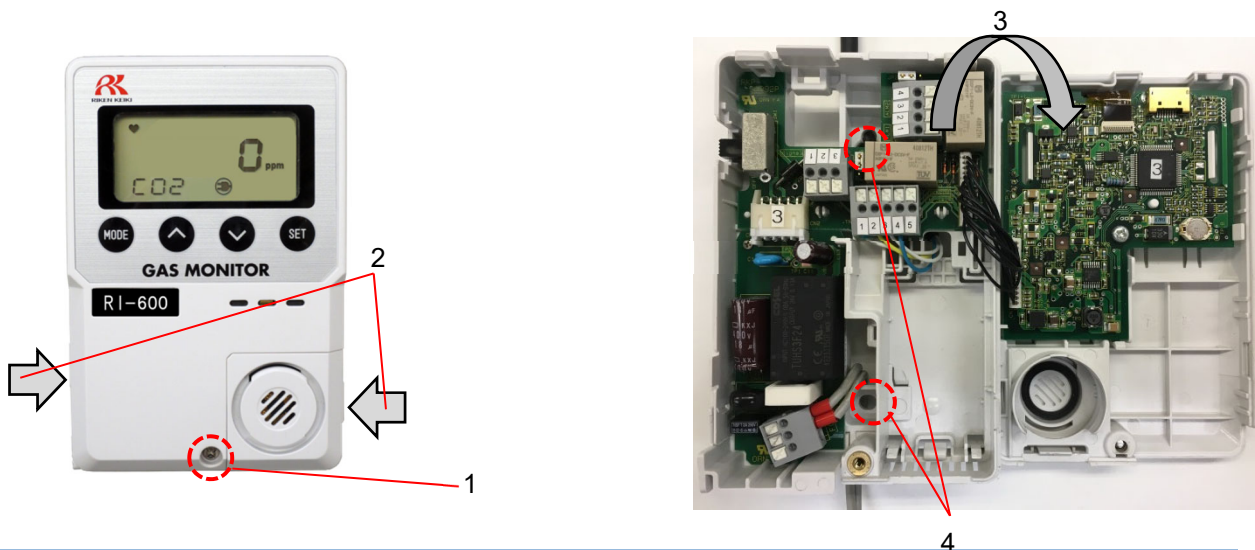

<Installation of Remote Sensor>

Tighten the screws through one upper mounting hole and one of the two lower mounting holes.

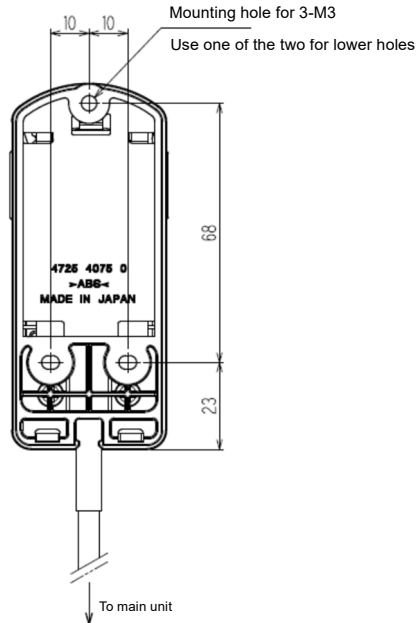

NOTE

- To install the remote sensor to the wall using screws, use the mounting holes on the back of the sensor according to the following procedure.
 - (1) Open the surface cover of the remote sensor.
 - (2) Fix the sensor with two screws (M3) through the mounting holes (one upper mounting hole and one of the two lower mounting holes).
 - (3) Put the cover back on the remote sensor.

<Maintenance Space>

If the installation board (option) is used, secure an installation space above the unit so that it can be installed by sliding.

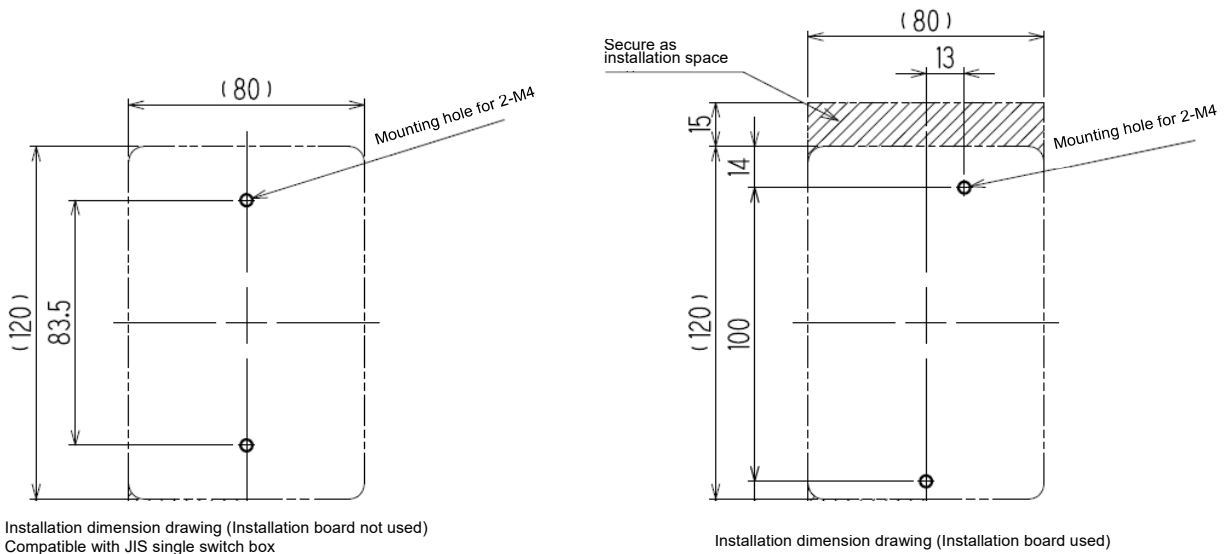

4-4. Precautions for wiring

If the monitor operates on AC or DC power, or inductive load is used at the alarm contact, wiring work is required.

The following cables are recommended for wiring the monitor with the power supply, signal cable and contact.

<Recommended Cables>

For AC power	Solid wire/stranded wire: 0.2 - 1.5 mm ²
For DC power	CVVS: 0.2 - 1.5 mm ²
For signal cable (4 - 20 mA/0 - 1 V)	CVVS: 0.2 - 1.5 mm ²
For contact	Cable such as CVV (0.2 - 1.5 mm ²) Up to 4 cores



CAUTION

- Be careful not to damage the internal electronic circuit when wiring. In addition, be careful not to apply stresses on the monitor when (overweight) cables are installed.
- The power and signal cables must be wired separately from the motor power cables.
- When stranded wires are used, prevent wires from contacting each other.

<Cable Connection Conditions>

Connectable cable, bare wire length and connection tools are as follows:

- Cable: 0.2 - 1.5 mm²
- Bare wire length: 10 - 11 mm
- Connecting tools: Dedicated screwdrivers manufactured by WAGO and equivalent (edge width 3.0 to 4.5 mm x 0.5 mm)



CAUTION

The specified bare wire length must be observed when the wire insulation is peeled off.

- Improper clamping of the wire due to a shorter bare wire length may cause defective electric conduction or heating.
- Catching the wire insulation due to a shorter bare wire length may cause defective electric conduction or heating.
- Exposing the wire due to a longer bare wire length may cause defective insulation or a short circuit.
- Be careful not to break up the wire. If the wire is broken up when inserted to the terminal, this may cause defective insulation or heating.

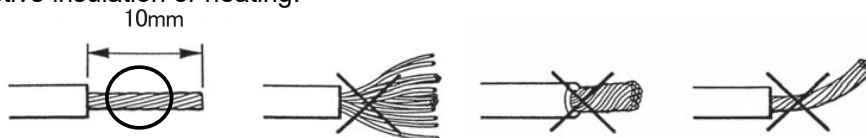

<Compatible Bar Terminal>

For a bar terminal, the following items are available.

- Bar terminal (ferrule): Model 216 Series (manufactured by WAGO)
- Crimping tool: Model VarioCrimp 4 (206-204) (manufactured by WAGO)



CAUTION

- A bar terminal of the specified model must be used. Using other bar terminals invalidates the warranty of the performance.

How to connect to terminal plate

When cables (wires) are connected to the terminal plate inside the main unit, use the dedicated screwdriver or a compatible flathead screwdriver.

When connecting a stranded wire, be sure to press the push button and open the spring while connecting the wire.

1 Push the push button straight downward using the compatible screwdriver or equivalent to open the spring.

2 Insert a wire with a specified bare wire length (10 mm) until the end of it reaches the deepest point.

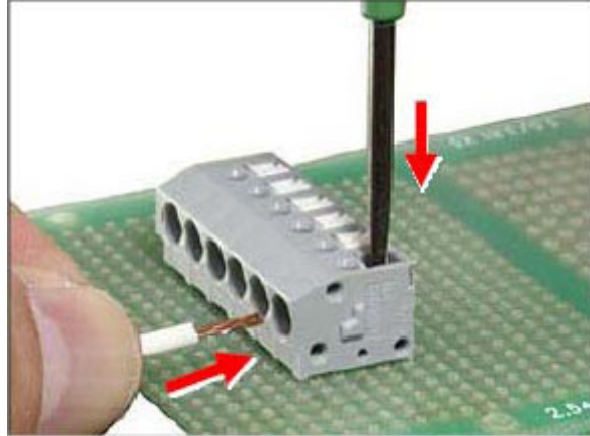

3 Release the screwdriver.
The wire is connected.



CAUTION

- Never fail to use the correct tool.
- Do not insert more than one wire into one wiring hole. If the total size (mm²) of two or more wires is within the maximum wire connection range of the terminal plate, it may cause reduced spring clamping force, defective insulation due to clogged wire sheath, defective contact or coming off of wires.

NOTE

<Compatible Screwdriver>

When opening the spring, use the compatible screwdriver manufactured by WAGO or equivalent (a screwdriver with an edge width of 3.0 to 4.5 mm x 0.5 mm which can fully open the spring: See the table below). In doing this work, be careful not to apply excessive force. Ignoring this may damage the housing/push buttons or cause dropping off of the push buttons.

Compatible screwdriver manufactured by WAGO	
Screwdriver (M) straight type	210-120J
Screwdriver (M) straight type (short shaft & grip)	210-350/01 210-657
Screwdriver (M) straight type (insulated shaft type)	210-720

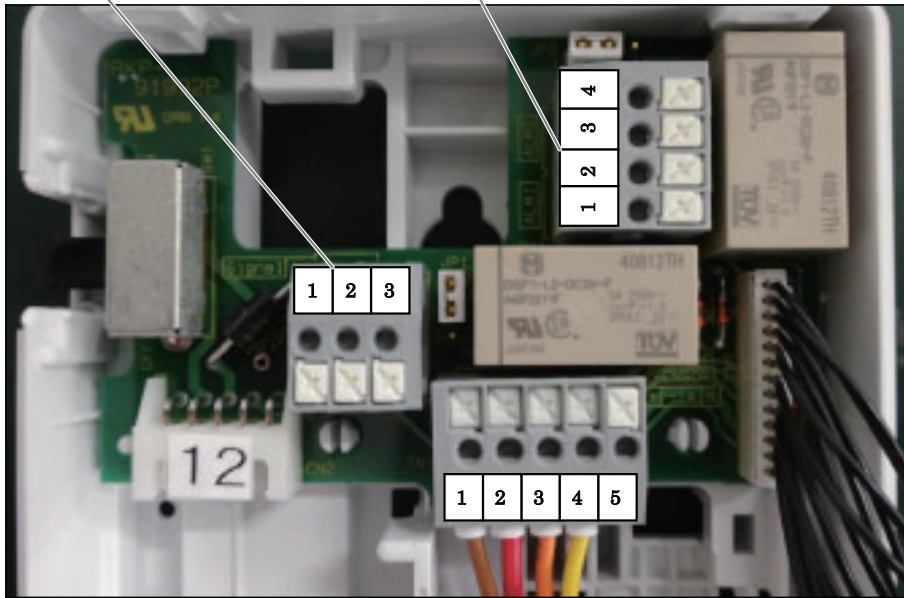

Figure of terminal plate

The overview of the terminal plate inside the main unit is as follows:

For external output signal
(4 - 20 mA/0 - 1 V) (TN2)
1: (+)
2: (-)

For contact (TN3)
1 - 2: ALM1 (First)
3 - 4: ALM2 (Second)



<For Connecting AC Power>

AC power (TND)
100 - 120 VAC \pm 10% (50 Hz/60 Hz)
1: L
2: N
3: Not used

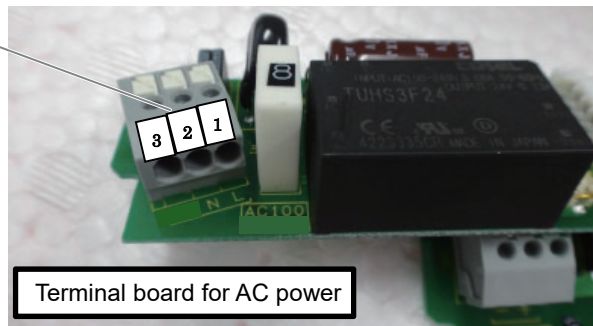

<For Connecting DC Power>

DC power (TND)
24 VDC \pm 10%
1: (+)
2: (-)
3: N.C

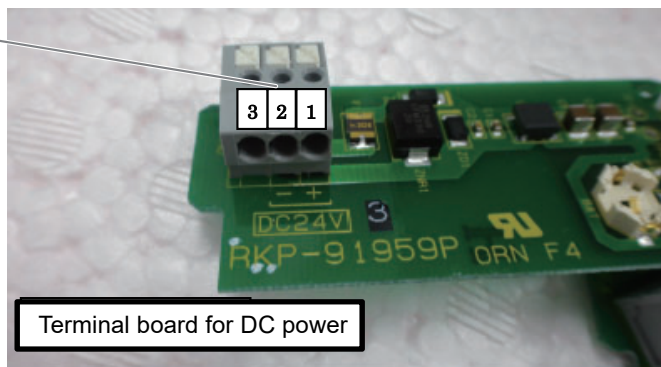

5

How to Use

5-1. Before using the monitor

Not only the first-time users but also the users who have already used the monitor must follow the operating precautions.

Ignoring the precautions may damage the monitor, resulting in inaccurate gas detection.



CAUTION

- After you received the monitor, start using the monitor within the specified operation start limit of its sensor.

5-2. Preparation for start-up

Check the following points before starting carbon dioxide concentration monitoring.

- Before turning on the power, check that the monitor is installed properly and the external wiring is done properly.
- Check that the power supply voltage is compliant with the specifications.
- Because the external contact may be activated during the adjustment, take measures to prevent an activated contact from having influences on external circuits.

5-3. Basic operating procedures

Normally, the detection mode is activated after the power is turned on.

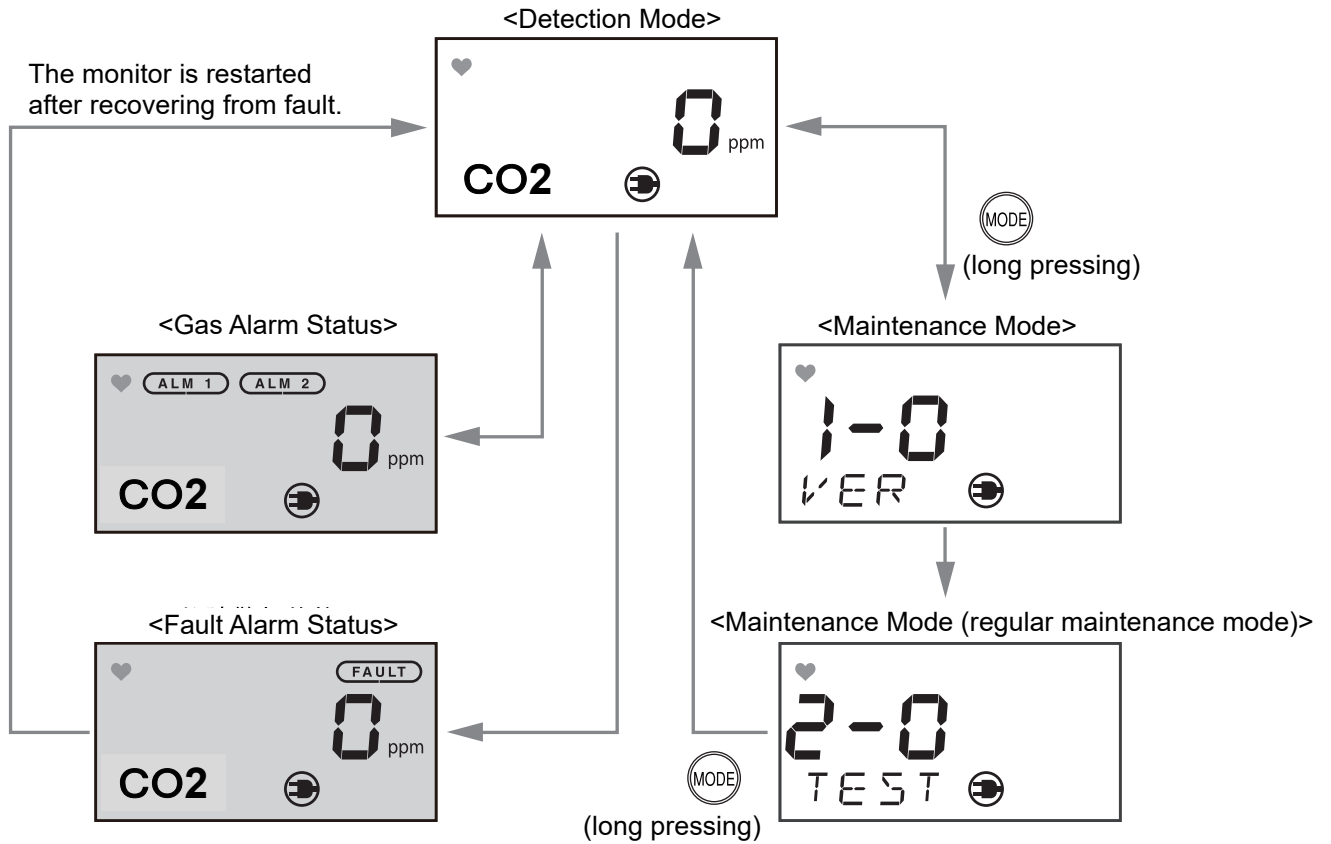

WARNING

- When the monitor enters each mode from the detection mode while an alarm is activated, the alarm contact is released.

5-4. Power-on

- Before turning on the power switch, check that the monitor is installed properly.
- Slide the power switch up to power on and down to power off.
- Turn on the power switch.
- After the monitor completes the start-up, it enters the detection mode.

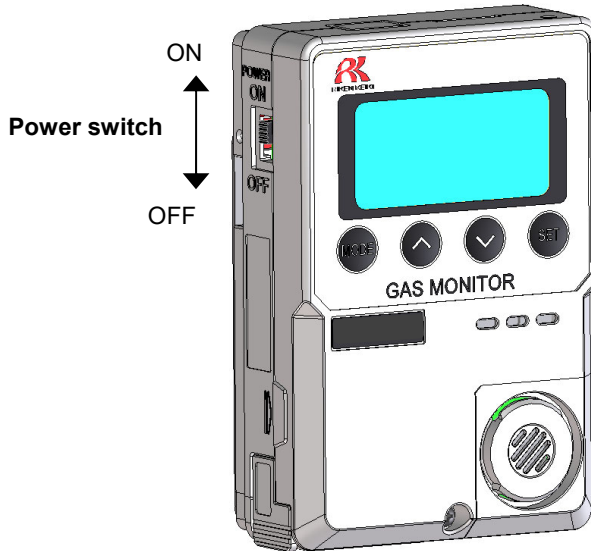

<Start-up Procedures (approximately 25 seconds for system check of the monitor and alarm deactivation)>

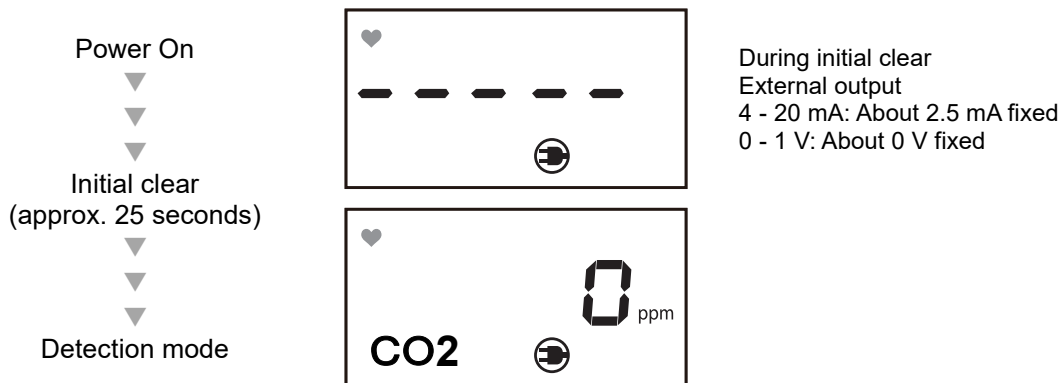

CAUTION

- Do not turn off the monitor during the initial clear. When turning it on again, abnormal operation may occur.
- After initial clear, perform calibration.
- In a normal air release environment, CO2 concentration is hundreds of ppm. Since the readings is not zero even in the normal state, attention is paid.
- When there are many people, and ventilation is insufficient, setting environment, please be careful because CO2 concentration may exceed 1000ppm(0.1vol%).

5-5. Modes

Mode	Item	LCD display	Details
Detection mode	—	Gas concentration Gas name	Normal state
Maintenance mode (User)	Version display	1-0 VER	Indicate the program version.
	Fresh air adjustment	1-1 AIR	Not used.
	Setting display	1-2 CONF	Show the typical settings. 1-20: First Alarm Setpoint (ALM1) 1-21: Second Alarm Setpoint (ALM2) 1-22: Alarm Delay Time (DELY) 1-23: Zero Suppression Value (SUPP) 1-24: Not used (----) 1-26: Not used (----) 1-27: Alarm Summary (AL-S)
	Regular maintenance mode switching	1-3 MMOD	Switch to the regular maintenance mode.
Maintenance mode (Regular maintenance)	Gas introduction display	2-0 TEST	2-00: Gas Test (GAS) 2-01: Alarm Test (ALM) 2-02: Fault Alarm Test (FALT) 2-03: Display Test (LCD) 2-04: Not used (----)
	Zero adjustment	2-1 ZERO	Perform the zero adjustment.
	Span adjustment	2-2 SPAN	Perform the span adjustment.
	Zero/span initialization	2-3 SDEF	Not used.
	Environmental setting	2-4 SET	2-40: Not used (----) 2-41: Not used (----) 2-42: Alarm Value Setting (AL-P) 2-43: Alarm Delay Time Setting (AL-D) 2-44: Alarm Pattern Setting (AL-T) 2-45: Zero Suppression Type Setting (SP-T) 2-46: Zero Suppression Value Setting (SAPP) 2-47: Not used (----) 2-48: External Output Adjustment (MA20) 2-49: Not used (----) 2-4A: Date/Time Setting (DATE) 2-4b: Not used (----) 2-4C: Not used (----) 2-4d: Buzzer ON/OFF Setting (BZZR) 2-4E: Gas Alarm Contact ON/OFF (AL-R) 2-4F: External Output Signal ON/OFF (MA-O) 2-4H: LCD Backlight ON/OFF (LCD)
	Display	2-5 DISP	2-50: Not used (----) 2-51: Not used (----) 2-52: Calibration Curve Number Display (GSEL) 2-53: Fault Detail Display (FALT) 2-54: Not used (----)
	Factory mode switching	2-6 FMOD	Not used.
	User mode switching	2-7 UMOD	Return to the user mode.

5-6. User mode



WARNING

- After adjustment is completed, never fail to press the **MODE** button to return to the detection mode. (If the monitor remains in the user mode, it automatically returns to the detection mode in ten hours.)

Detection mode

Press the **MODE** button for three seconds.



User mode

1-0. VER

Indicate the program version.

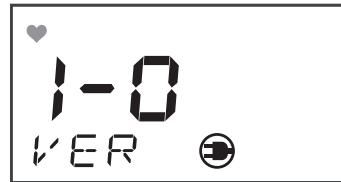

1-1. AIR

Not used.



1-2. CONF

Display various setting values.



1-3. MMOD

Switch to the regular maintenance mode.

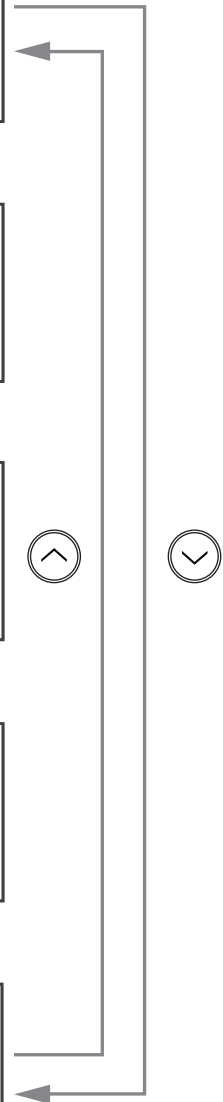

<Setting Display "1-2">

This is used to check the setting of typical menus.

1-2. CONF
Press the **SET** button.



First Alarm Setpoint Display
Press the **SET** button to display the first alarm setpoint.



Second Alarm Setpoint Display



Alarm Delay Time Display (seconds)



Zero Suppression Value Display



**Zero Follower
ON/OFF Display**
Not used.

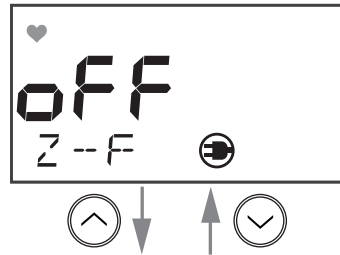

**Air Pressure
Correction ON/OFF
Display**
Not used.

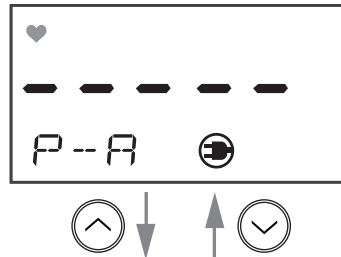

Alarm Summary

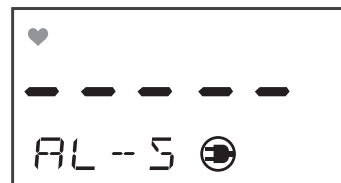

5-7. Power-off

Slide the power switch down to power off.

After turning off the power switch of the monitor, turn off the power supply (100 VAC or 24 VDC) of the monitor.



CAUTION

- When the monitor is turned off, an alarm may be triggered on the upper (central) system. Before turning off the monitor, the inhibit (point skip) on the upper (central) system must be activated. Decide whether the power can be turned off by checking the operation of the devices connected to the external output or external contact output terminal of the monitor.

6

Alarm Activation and Functions

6-1. Gas alarm activation

A gas alarm is activated when detected gas concentration reaches the preset alarm setpoint.

NOTE

- The alarm setpoint (first alarm and second alarm) is factory-set. The setting values can be changed in the maintenance mode (P.29).
- Although the alarm delay time (standard: 2 seconds) works in the monitor to prevent a false activation, it can be cancelled in the maintenance mode (P.29) if not needed.

Display operation

<Concentration Display>

In case of over the detection range (Over Scale), "〇〇〇〇" is displayed on the LCD.

<During Power-on>

The LCD is continuously displayed.

<Alarm Display (ALM1: Yellow Backlight), (ALM2: Red Backlight)>

The alarm consists of two steps. The yellow or red backlight lights up when the respective alarm setpoint value is reached to or exceeded. (Default: Backlight is off)

Contact activation

When gas concentration reach or is above the alarm setpoint value, the contact is activated and after the gas concentration fall down below the alarm setpoint value, the contact activation is reset automatically. In case of measuring range : 0-2000ppm/0-5000ppm/0-10000ppm specification, hysteresis of 50ppm is provided.

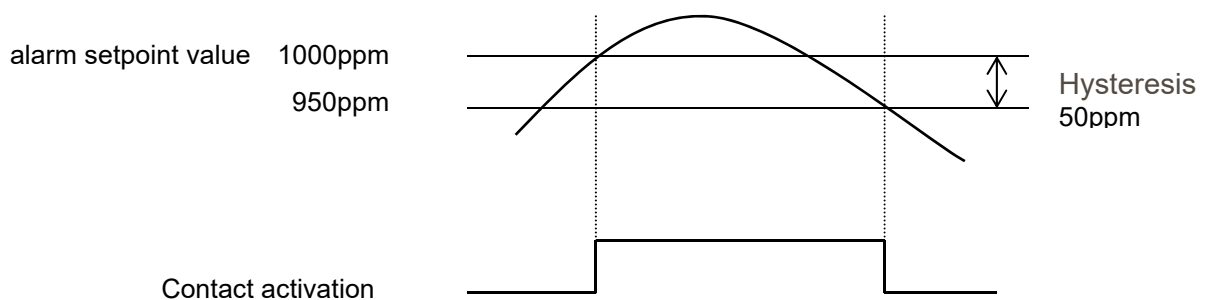

6-2. Fault alarm activation

A fault alarm is triggered when an abnormality is detected in the monitor. After a fault alarm is triggered, FAULT is displayed and the backlight (red) lights up on the LCD. (An error message is displayed on the LCD. Determine the causes and take appropriate actions.)

After the monitor is successfully returned from the fault, it restarts with the process normally performed right after it is turned on (initial clear).

If the monitor has problems and is repeatedly malfunctioning, contact RIKEN KEIKI immediately.

NOTE

- For information on malfunctions (error messages), see "Troubleshooting" (P.45).

6-3. External output operation

The monitor outputs an analog signal of 4 - 20 mA according to CO2 concentration display on the LCD

Gas concentration VS External output

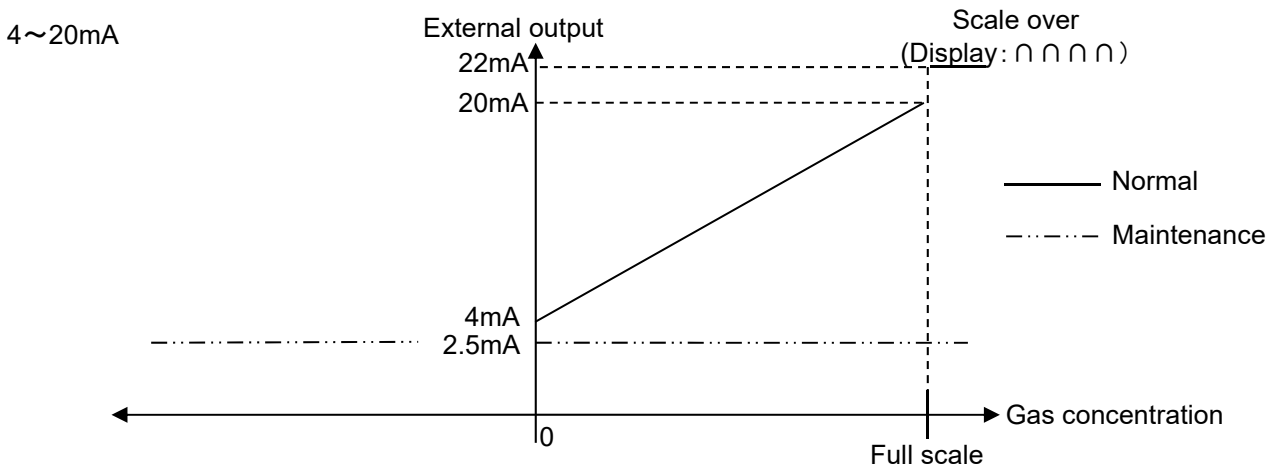

< 4 - 20 mA Output Table >

Status	External output (4 - 20 mA)	Remarks
Initial	2.5mA	Fixed values
Normal	4.0~20.0mA	Depending on gas concentration
Scale over	22mA	Fixed values
Trouble	0.5mA	Fixed values
Maintenance mode menu	2.5mA	Fixed values
Air calibration	2.5mA	Fixed values
Alarm setpoint check	2.5mA	Fixed values
Alarm summary check	2.5mA	Fixed values
Date/time check and setting	2.5mA	Fixed values
Alarm test	4.0~20.0 mA	Depending on test value

7

Maintenance

The monitor is an important instrument for the purpose of safety. To maintain the performance of the monitor and improve the reliability of safety, perform a regular maintenance.

7-1. Maintenance intervals and items

This is a safety unit. Never fail to perform daily and regular maintenance before use.

- Daily maintenance: Perform maintenance before commencing each work.
- Regular maintenance: Perform maintenance once or more for every six months to maintain the performance as a safety unit.

Maintenance item	Maintenance content	Daily maintenance	Regular maintenance
Power supply check	Check that the LCD display lights up.	○	○
Concentration display check	Check that the concentration display value does not become the abnormal concentration or abnormal variation. *The CO ₂ concentration is also present in the hundreds of ppm under the general air environment.	○	○
Alarm test	Inspect the alarm circuit by using the alarm test function.	—	○
Span Adjustment	Perform span adjustment using a calibration gas.	—	○
Gas alarm check	Check the gas alarm using a calibration gas.	—	○



WARNING

- If an abnormality is found in the monitor, contact RIKEN KEIKI immediately.

About maintenance services

We provide services on regular maintenance including such as span adjustment, other adjustments and maintenance.

To make the calibration gas, dedicated tools, such as a gas cylinder of the specified concentration and gas sampling bag must be used.

Our qualified service engineers have expertise, knowledge, etc. on the dedicated tools used for services, along with other products.

To maintain the safety operation of the monitor, please use our maintenance service.

Typical maintenance services are listed as follows. For details, please contact RIKEN KEIKI.

<Typical Maintenance Services>

Item	Services
Power supply check	Checks the power supply voltage. Checks that the LCD display lights up. (Verifies that relevant points can be identified on the system.)
Concentration display check	Check that the concentration display value does not become the abnormal concentration or abnormal variation. *The CO2 concentration is also present in the hundreds of ppm under the general air environment.
Alarm test	Inspects the alarm circuit by using the alarm test function. Checks the alarm display (Checks the activation each for ALM1 and ALM2.)
Span adjustment	Performs span adjustment using a calibration gas.
Gas alarm check	Checks the gas alarm by using the calibration gas. Checks the alarm. (Checks triggering of alarm when the alarm setpoint is reached.)
Cleaning and repair of the unit	Checks dust or damage on the surface, cover or internal parts of the unit, and cleans or repairs such parts as needed. (Visual diagnosis) Replaces parts which are cracked or damaged.
Unit operation check	Operates the buttons to check the operation of functions and parameters, etc.
Replacement of consumable parts	Replaces consumable parts, such as a sensor.

7-2. Maintenance (regular maintenance) mode

The maintenance mode allows for checking the status of the monitor and adjusting and changing the settings.



WARNING

- When the adjustment is completed, press the **MODE** button to return to the measuring state. The monitor automatically returns to the measuring state in 10 hours.

Mode	Item	LCD display	Details
Maintenance mode (Regular maintenance)	Gas introduction display	2-0 GAS TEST	2-00: Gas Test 2-01: Alarm Test 2-02: Fault Alarm Test 2-03: Display test 2-04: Not used (----)
	Zero adjustment	2-1 ZERO	Perform the zero adjustment.
	Span adjustment	2-2 SPAN	Perform the span adjustment.
	Zero/span initialization	2-3 SDEF	Not used.
	Environmental setting	2-4 SET	2-40: Not used (----) 2-41: Not used (----) 2-42: Alarm Value Setting (AL-P) 2-43: Alarm Delay Time Setting (AL-D) 2-44: Not used (----) 2-45: Zero Suppression Type Setting (SP-T) 2-46: Zero Suppression Value Setting (SAPP) 2-47: Not used (----) 2-48: External Output Adjustment (MA20) 2-49: Not used (----) 2-4A: Date/Time Setting (DATE) 2-4b: Not used (----) 2-4C: Not used (----) 2-4d: Buzzer ON/OFF Setting (BZZR) 2-4E: Gas Alarm Contact ON/OFF (AL-R) 2-4F: External Output Signal ON/OFF 2-4H: LCD Backlight ON/OFF (LCD)
	Display	2-5 DISP	2-50: Not used (----) 2-51: Not used (----) 2-52: Calibration Curve Number Display (GSEL) 2-53: Fault Detail Display (FALT) 2-54: Not used (----)
	Factory mode switching	2-6 F MODE	Not used.
User mode switching	2-7 U MODE	Return to the user mode.	

<Regular Maintenance Mode>

User mode

Press the **SET** button in "1-3. M MOD".

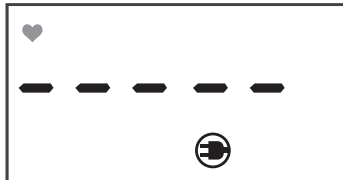

(long pressing)



Then press the **SET** button again for three seconds.

2-0. GAS TEST

Perform a test with the gas. Similar to the detection condition, the reading changes and an alarm is displayed after gas is introduced, but the "ALM1" and "ALM2" do not flash and the contact is not activated.

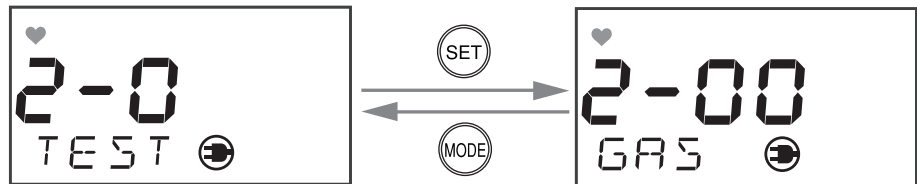

2-1. ZERO

Perform the zero adjustment.

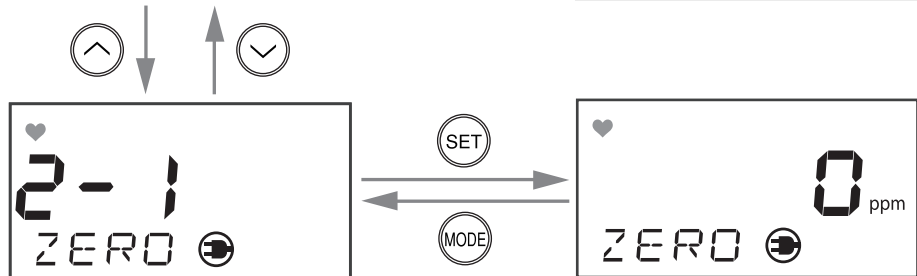

2-2. SPAN

Perform the span adjustment.

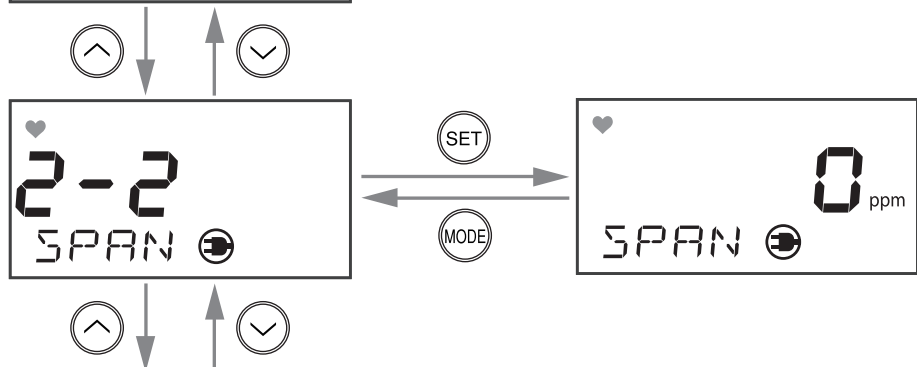

2-3. SDEF
Not used.

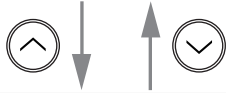
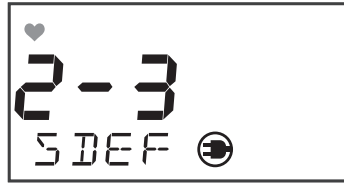

2-4. SET
Specify various settings.

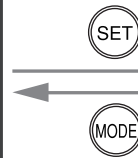

2-5. DISP
Provide various detail displays.

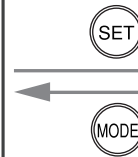

2-6. F MODE
Not used.

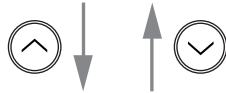
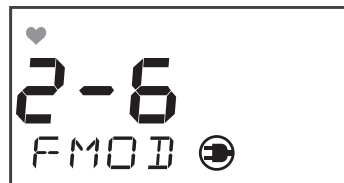

2-7. U MODE
Return to the user mode.

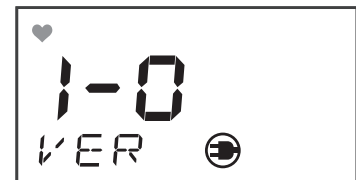
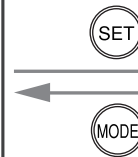

<Gas Introduction Display>

2-0. GAS TEST
 Perform a test with the gas.
 Similar to the detection mode, the reading changes and an alarm is displayed after the gas is introduced, but the contact is not activated.

2-00. GAS
 Perform the gas test.

2-01. ALM
 Perform the alarm test.
 Use the Δ button to increase the display value to the alarm setpoint to trigger an alarm.

2-02. FALT
 Conduct a fault alarm test.
 Use the Δ or ∇ button to enable the function to trigger an alarm.

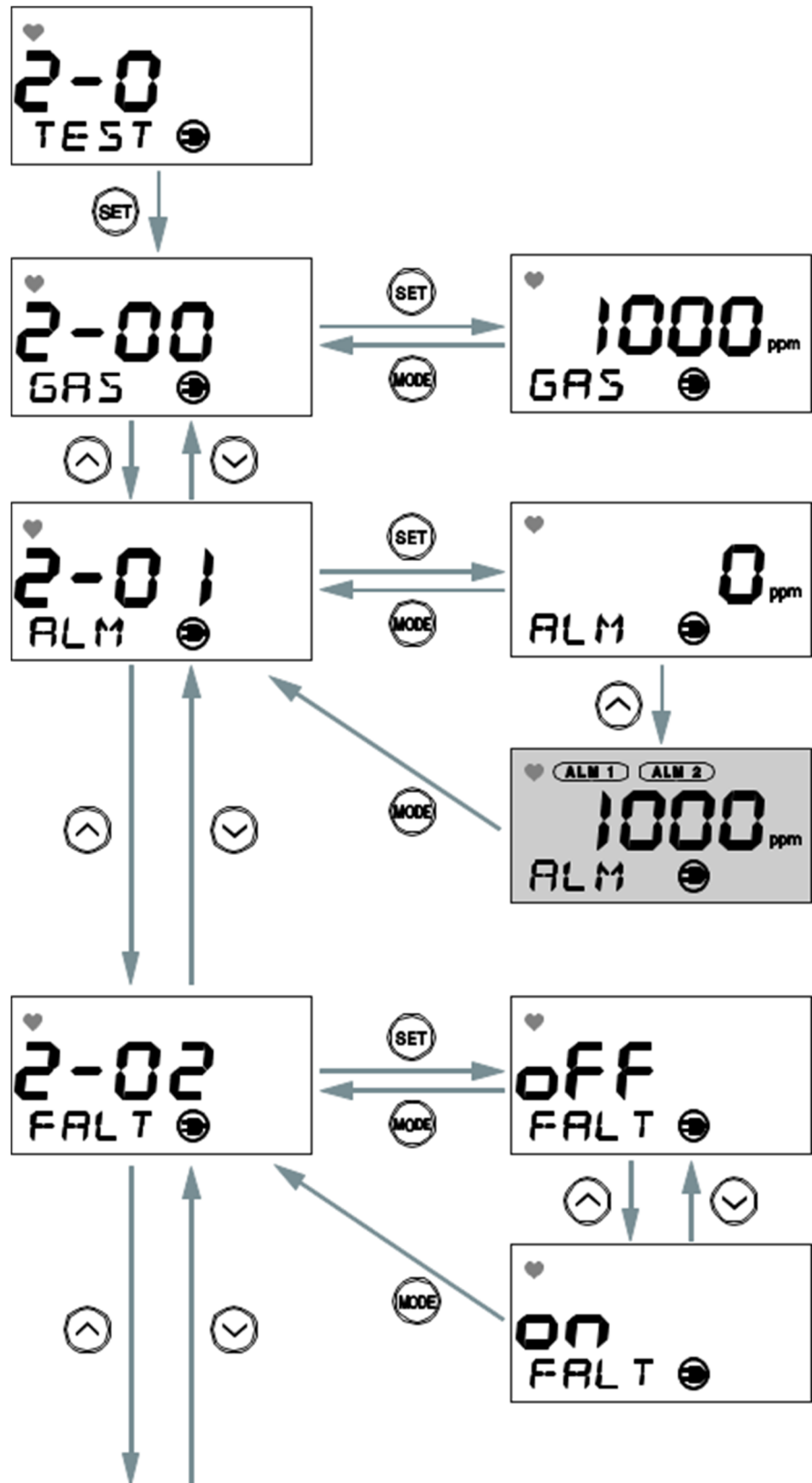

2-03. LCD
Perform the LCD display test.

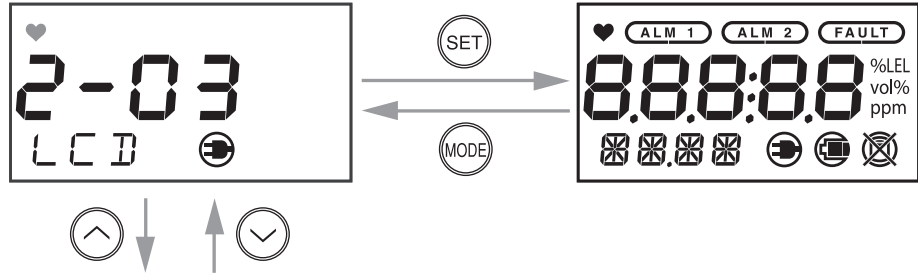

2-04.
Not used.

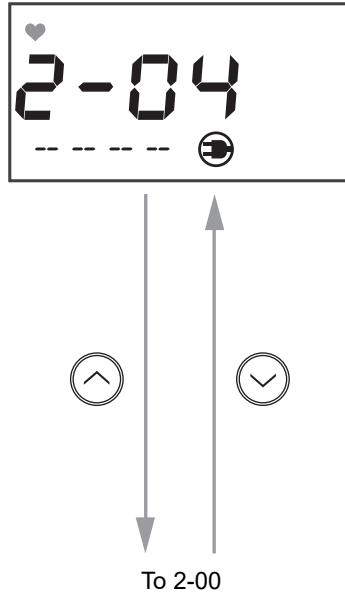

<Zero Adjustment>

2-1. ZERO
Perform the zero adjustment.

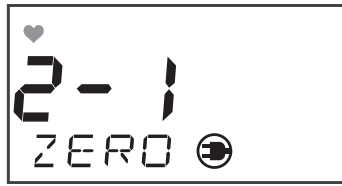

The current concentration is displayed.

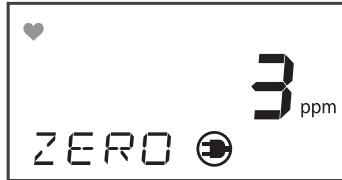

Supply zero adjustment gas to the sensor.

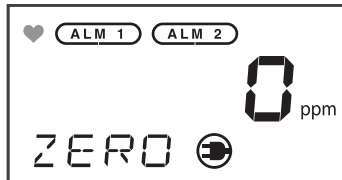

Press the **SET** button.

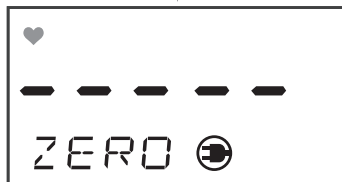

"PASS" is displayed when adjustment is completed, and "FAIL" is displayed when it fails.



Zero adjustment will end.



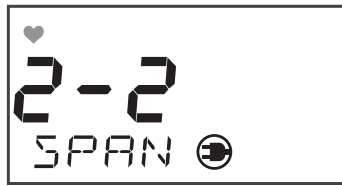

2-2. SPAN

Perform the span adjustment.



The current concentration is displayed.



Use the  or  button to adjust the reading to the span adjustment gas concentration and press the **SET** button.

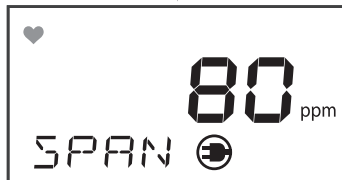

"PASS" is displayed when adjustment is completed, and "FAIL" is displayed when it fails.



Span adjustment will end.



<Environmental Setting>

2-4. SET
Specify various settings.



2-40.
Not used.

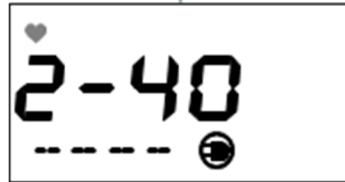

2-41.
Not used.

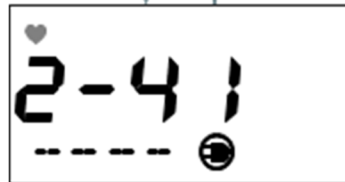

2-42. AL-P
Set the alarm setpoint (first, second).
Use the or button to set the alarm setpoint and press the **SET** button to confirm it.

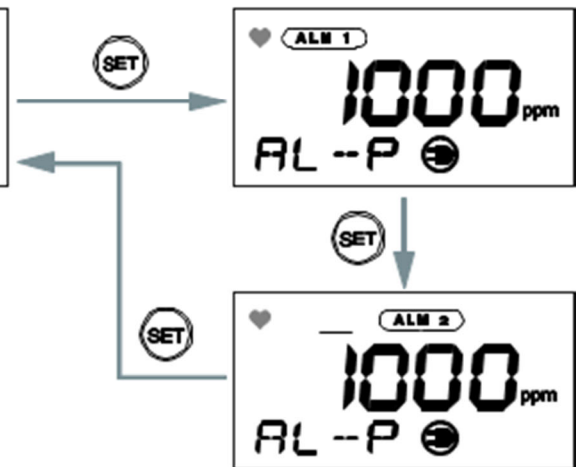
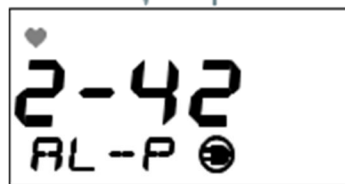

2-43. AL-D
Set the alarm delay time (seconds).
Use the or button to set the time (seconds) and press the button to confirm it.



2-44. AL-T
Not used.

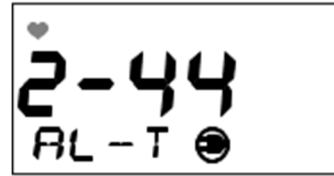

2-45. SP-T
Not used.

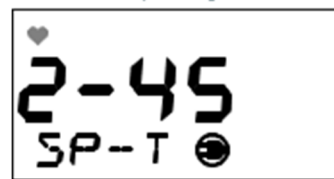

2-46. SAPP
S Not used.



2-47.
Not used.



2-48. MA20
Adjust the external output (4 mA, 20 mA). Connect an ammeter. Then, use the Δ or ∇ button to select the value and press the **SET** button to confirm it.

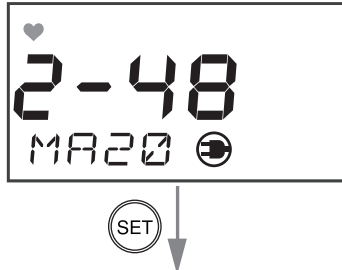

2-48. MA20
Adjust the external output (4 mA, 20 mA). Connect an ammeter. Then, use the Δ or ∇ button to select the value and press the **SET** button to confirm it.

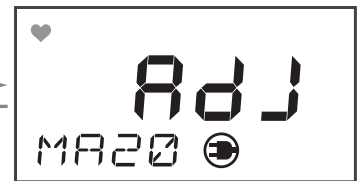
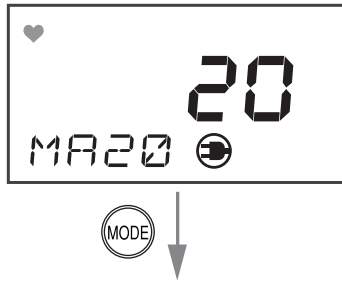
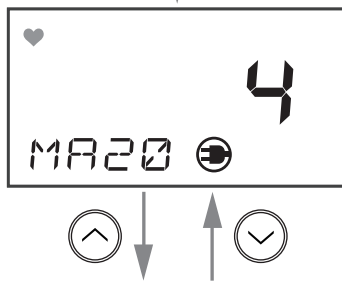

Connect an ammeter. Then, use the Δ or ∇ button to adjust output (4 mA) and press the **SET** button to confirm it.

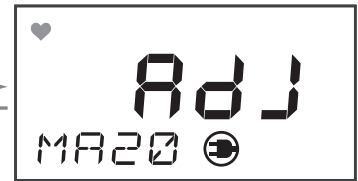



Connect an ammeter. Then, use the Δ or ∇ button to adjust output (20 mA) and press the **SET** button to confirm it.

2-49. SSET
Not used.



2-4A. DATE

Set the date/time.
Use the  or  button to select each value in the order of year, month, day, hour and minute and press the **SET** button to confirm it.

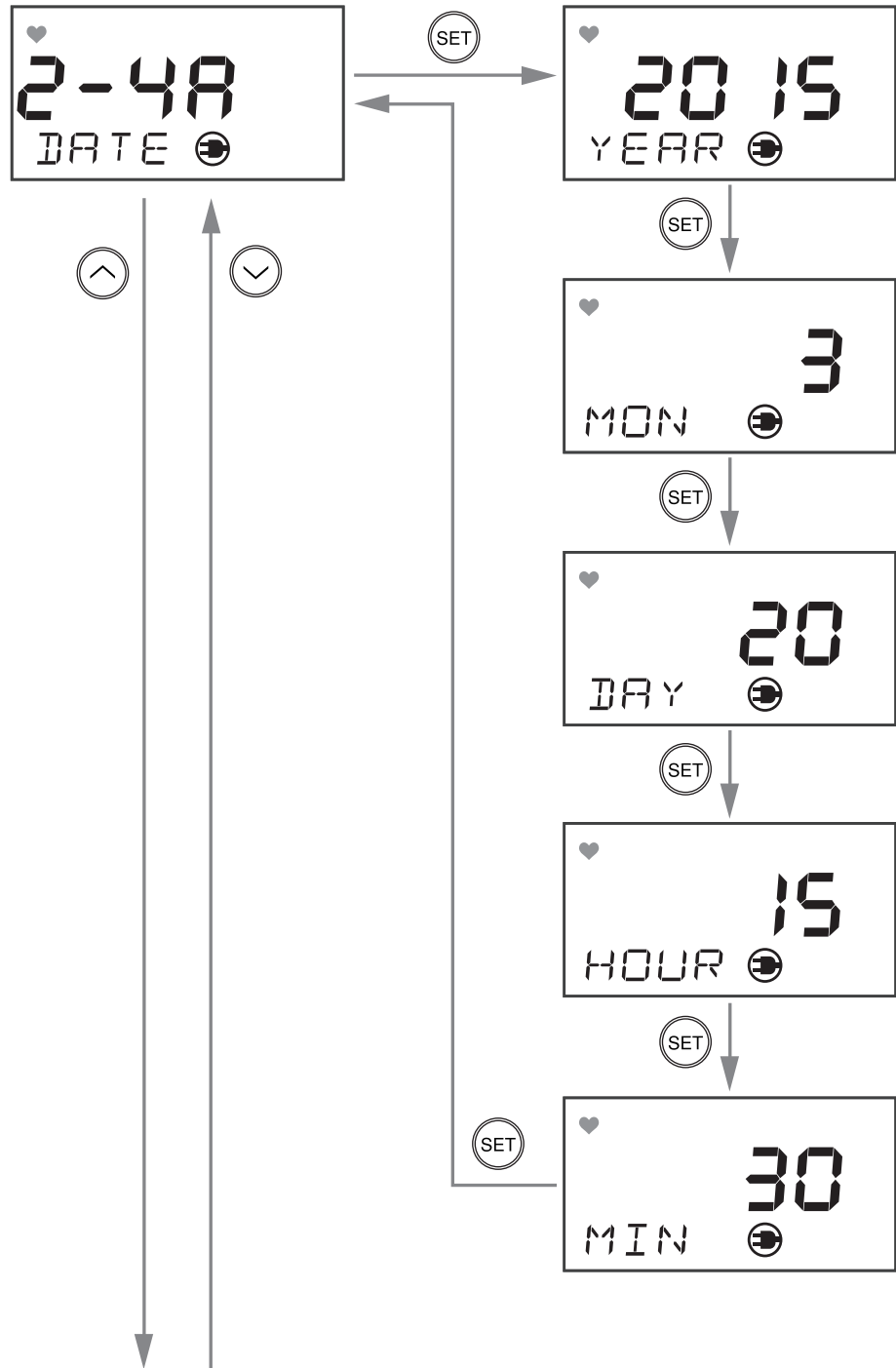

2-4b. P-A
Not used.

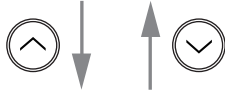

2-4c. ACAL
Not used.



2-4d. BZZR
Set the buzzer to ON/OFF.

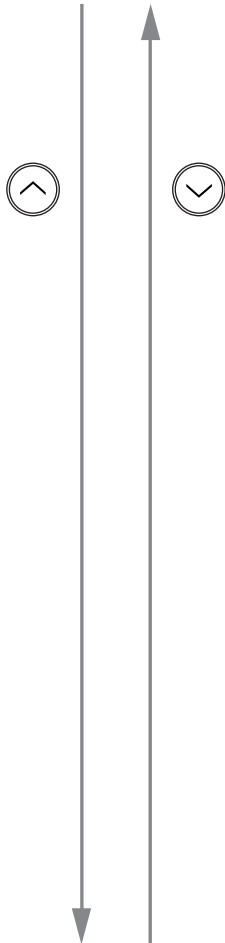

SET

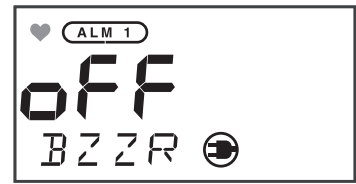
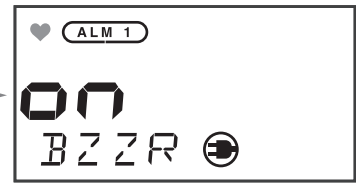

SET

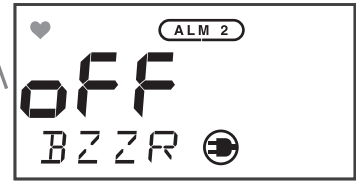
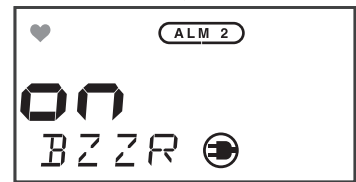

SET

2-4E. AL-R
Set the gas alarm state contact to ON/OFF.

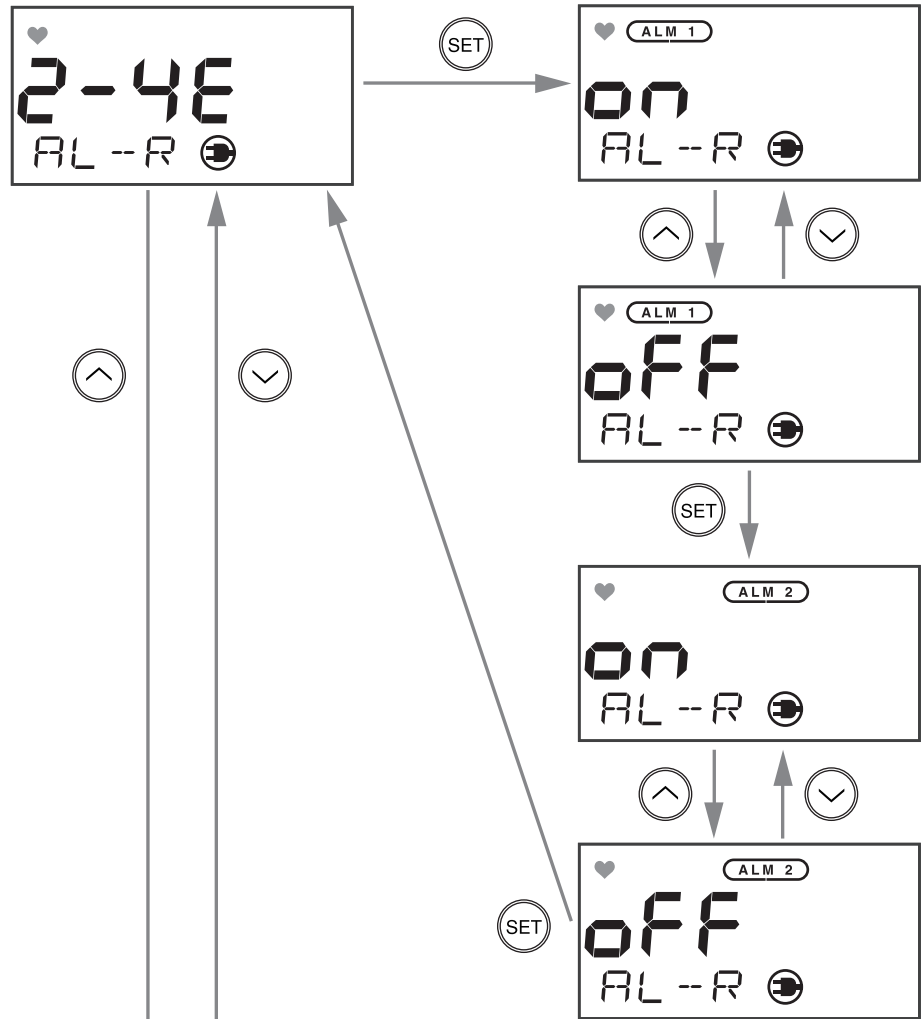

2-4F. MA-O
Set the external output signal to ON/OFF.

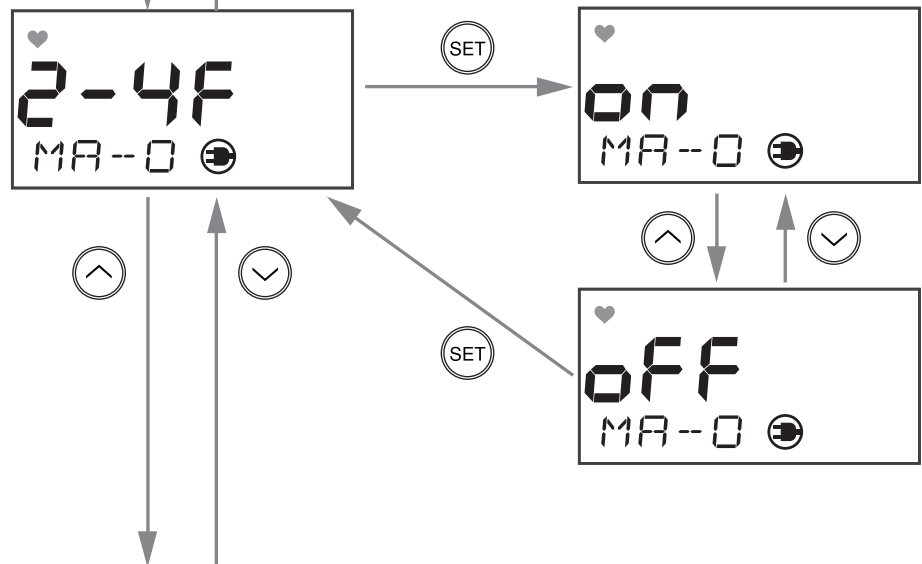

2-4H. LCD
Set the LCD backlight
to ON/OFF.
*No backlight by
standard setting

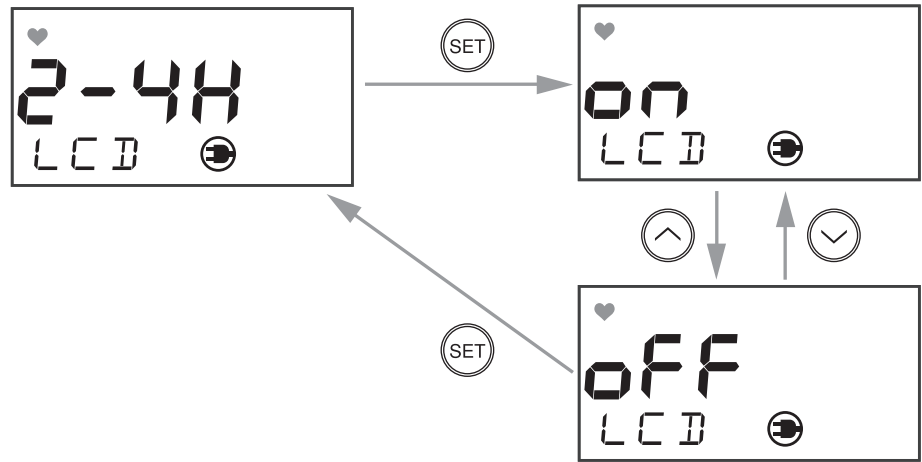

8

Storage and Disposal

8-1. Procedures to store the monitor or leave it for a long time

The monitor must be stored under the following environmental conditions.

- In a dark place under the normal temperature and humidity away from direct sunlight
- In a place where gases, solvents or vapors, etc. are not present

Store the monitor in a shipping carton, if any, in which the product was delivered.

Store the monitor away from dust, etc. if the shipping carton is not available.

8-2. Procedures to relocate the monitor or use it again

When the monitor is relocated, refer to "How to Install" for relocation sites and wiring work.

The unpowered time must be minimized when the monitor is relocated.

When the monitor is used again after a long-period storage, perform a calibration.



CAUTION

- Contact RIKEN KEIKI for information on readjustment including calibration.

8-3. Disposal of products

When the monitor is disposed of, it must be treated properly as an industrial waste in accordance with the local regulations, etc.

Never fail to return the used sensor to RIKEN KEIKI.

9

Troubleshooting

The Troubleshooting does not explain the causes of all the malfunctions which occur on the monitor. This simply helps to find the causes of malfunctions which frequently occur.

If the monitor shows a symptom which is not explained in this manual, or still has malfunctions even though remedial actions are taken, please contact RIKEN KEIKI.

Symptom/Display	Causes	Actions
The power cannot be turned on.	The power switch is turned off.	Turn on the power switch.
	Abnormalities/momentary blackout of power supply system	Provide the rated voltage. Take measures such as checking or adding the UPS, power supply line filter and insulation transformer.
	The main unit is not installed properly.	Check whether the main unit is properly attached to the wall-mounted unit.
	Cable abnormalities (open circuit/not connected/short circuit)	Check the wiring of the monitor and related devices around it.
	Fault of AC adapter	AC adapter replacement is necessary. Please contact RIKEN KEIKI.
	The connector of AC adapter is not connected correctly.	Connect the AC adapter correctly.
Abnormal operations	Disturbances by sudden surge noise, etc.	Turn off and restart the monitor. If a symptom like this is observed frequently, take appropriate measures to eliminate the noise.
Sensor abnormalities E-1	The sensor is not connected or improperly connected.	Check that the sensor is connected and the connectors of the sensor unit board are securely fastened.
	Errors in communication with the unit	Replace the sensor unit board with a new one.
System abnormalities E-9 SYSTEM	The rated voltage is not supplied to the monitor.	Check the power supply, and supply the rated voltage.
	Abnormalities of ROM, RAM or EEPROM inside the monitor	Please contact RIKEN KEIKI.
The reading drops and it remains so.	Sudden change in the temperature and CO2 concentration.	Please use it in the stable environment of the change of temperature and the CO2 concentration.
	Disturbance by noise	Turn off and restart the monitor. If a symptom like this is observed frequently, take appropriate measures to eliminate the noise.
Span adjustment impossible	Improper calibration gas concentration	Use the proper calibration gas.

Symptom/Display	Causes	Actions
	Deteriorated sensor sensitivity	Replace the sensor with new one.

10

Product Specifications

10-1. List of specifications

Detection principle	Non-Dispersive Infrared Ray
Gas to be detected	Carbon dioxide
Concentration display*1	LCD digital display (Five-digit, seven-segment/green, orange and red backlight) *No backlight by standard setting
Detection range	0 - 2000ppm / 0 - 5000ppm / 0 - 10000ppm 0 - 2vol% / 0 - 5vol%
Display resolution	0 - 2000ppm : 1 ppm / 2000ppm - 10000ppm:10ppm 0 - 2vol%:0.005vol% / 2 - 5vol%:0.010vol%
Detection method	Diffusion type
Alarm setpoint value	0 - 2000ppm 1st : 1000ppm / 2nd : 1000ppm[standard setting] 0 - 5000ppm 1st : 1000ppm / 2nd : 1000ppm[standard setting] 0 - 10000ppm 1st : 1000ppm / 2nd : 1000ppm[standard setting] 0 - 2vol% 1st : 1.0vol% / 2nd : 1.0vol%[standard setting] 0 - 5vol% 1st : 2.5vol% / 2nd : 2.5vol%[standard setting]
Accuracy Under the same test conditions	Within $\pm 5\%$ for full scale (to the gas concentration signal output)
Response time Under the same test conditions	90% response (T90) within 60 seconds
Gas alarm type	Two-step alarm (H-HH)
Gas alarm display	First: Lights up the concentration display and backlight (orange), buzzer Second: Lights up the concentration display and backlight (red), buzzer *No backlight and no buzzer by standard setting
Gas alarm pattern	Auto-reset
Gas alarm contact	No-voltage contact 1a or 1b and normally de-energized (energized in response to an alarm)
Fault alarm/self diagnosis	System abnormalities/sensor connection abnormalities
Fault alarm display	Alarm detail display and backlight blinking (orange), buzzer *No backlight by standard setting
Fault alarm pattern	Auto-reset
Contact capacity	125 VAC - 1 A or 30 VDC - 1 A (resistance load) * For CE/UKCA marking specifications, 30VDC, 1A (resistive load) only.
Transmission specifications	4 - 20 mA DC (no-insulation/load resistance under 300 Ω)
Power supply	100 - 120 VAC $\pm 10\%$ (50/60 Hz) or 24 VDC $\pm 10\%$ * For CE/UKCA marking specifications, 24VDC $\pm 10\%$ only.
Power consumption	AC specification: Max. 6 VA/DC specification: Max. 4 W
Initial clear	Approx. 25 seconds
Warm-up time	Approx. 30 minutes
Operating temperatures	0 - 40°C (At a constant condition)
Operating humidities	Below 90%RH (Non-condensing)
Structure	Wall mounting type, sensor integrated type or remote type *Remote type is only 0-2vol%/0-5vol%.
External dimensions	Main unit: Approx. 80(W)x120(H)x 35.5(D)mm Remote sensor: Approx. 40(W)x96(H)x35.5(D)mm (projection portions excluded)
Weight	AC specification: Approx. 200 g/DC specification: Approx. 180 g Remote sensor part: Approx. 55g (cable excluded)

11

Appendix

11-1. Detection principle of Non-Dispersive Infrared Ray

Model RI-600 applies Non-Dispersive Infrared Ray Absorption(NDIR) technique to detect target gas. The infrared beam emitted from the light source passes through the gas cell and reaches to IR sensor. The target gas enters into gas cell from gas inlet. When target gas is entered into gas cell, the amount of infrared ray to be received by IR sensor decreases since the infrared ray emitted from IR source is absorbed by the target gas. This decreased amount is detected by IR sensor and output as gas concentration. There is a optical band pass filter in front of IR sensor which can pass the absorption wave of target gas. Then, there is no sensitivity for the gas which has the different absorption wave from the target gas. Furthermore, there is no sensitivity against N₂ and H₂ etc. which cannot absorb infrared ray.

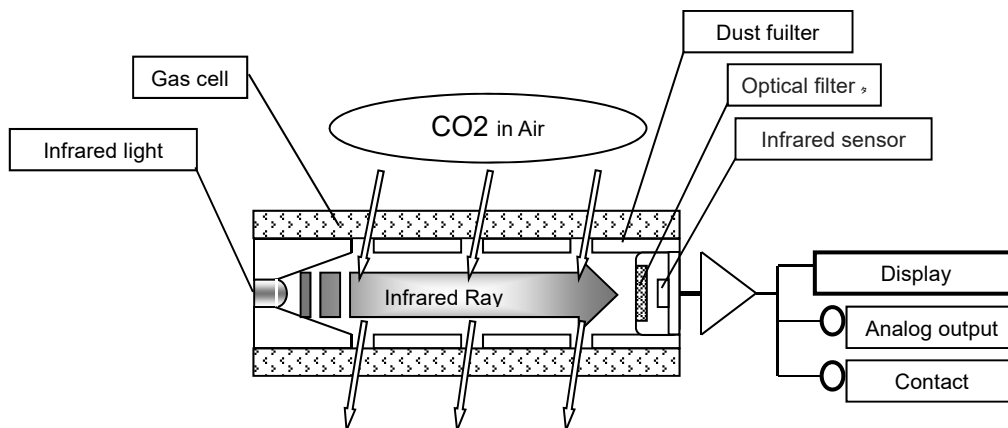

11-2. Definition of terms

ppm	Gas concentration indicated in the unit of one-millionth of the volume
vol%	Gas concentration indicated in the unit of one-hundredth of the volume
Calibration	Find relationship of the readings, display values or setpoints with the actual values by using the calibration gas, etc.
Maintenance mode	When maintenance is performed on the monitor, the alarm contact is disconnected, and a signal to indicate the maintenance mode status is sent out to the external output signal. As a result, maintenance can be performed on a single unit of the monitor.
Initial clear	The reading is unstable for seconds after the power is turned on. To prevent malfunctions for that period, the alarm contact is deactivated. In addition, a signal to indicate the initial clear status is sent out to the external output.
Zero suppression	A function to cut off the influences of environmental changes, interference gases, etc.
Alarm delay time	A function which temporarily suspends activation to prevent a false alarm caused by noise from its outside.

Manual Log

Rev.	Amendment	Issue data
0	First issue	2017/7/7
1	P47 correction : Fault alarm display	2017/10/30
2	P45 correction : Troubleshooting	2018/1/18
3	P12, 47 correction : Power supply 100-120VAC ± 10%(50/60Hz)	2018/8/24
4	Correction : Declaration of Conformity	2020/4/1
5	Added a section on remote sensor.	2021/1/18
6	Declaration of Conformity	2021/11/12
7	Correction : CE Declaration of Conformity, Addition : UKCA Declaration of Conformity	2022/7/11
8	Correction : CE Declaration of Conformity	2024/6/14



EU-Declaration of Conformity

Document No. 320CE24011



We, RIKEN KEIKI Co., Ltd. 2-7-6, Azusawa, Itabashi-ku, Tokyo, 174-8744, Japan declare under our sole responsibility that the following product conforms to all the relevant provisions.

Product Name Indoor Carbon Dioxide Monitor
Model RI-600(DC model)

Council Directives	Applicable Standards
EMC Directive (2014/30/EU)	EN 50270:2015
BATTERY Regulation ((EU)2023/1542)	-
RoHS Directive (2011/65/EU[1])	EN IEC 63000:2018

^[1]Including substances added by Commission Delegated Directive (EU) 2015/863

Place: Tokyo, Japan

Date: Jun. 12, 2024

Takakura Toshiyuki
General manager
Quality Control Center



UK-Declaration of Conformity

Document No.: 320UK22004



We, RIKEN KEIKI Co., Ltd. 2-7-6, Azusawa, Itabashi-ku, Tokyo, 174-8744 Japan declare under our sole responsibility that the following product conforms to all the relevant provisions.

Product Name: Indoor Carbon Dioxide Monitor
Model: RI-600(DC model)

Regulations	UK designated Standards
Electromagnetic Compatibility Regulations 2016 (S.I. 2016/1091)	BS EN 50270:2015
The Restriction of the Use of Certain Hazardous Substances in Electrical and Electronic Equipment Regulations 2012 (S.I. 2012/3032)	BS EN IEC 63000:2018

Place: Tokyo, Japan

Date: May. 27, 2022

Takakura Toshiyuki
General manager
Quality Control Center